

Fuji Electric High-Performance Hybrid SiC Modules Equipped with a Next Generation Device

Fuji Electric Hybrid SiC modules consist of a SiC based SBD (Schottky Barrier Diode) and Si based IGBT (Insulated Gate Bipolar Transistor). With a capacity line-up ranging from 1200 V to 3300 V, this series contributes to energy saving and miniaturization in various types of industrial equipment.

- Configured with a “X Series / V Series IGBT + SiC-SBD” high-performance, low-loss chip-set
- Contributes to energy savings in power conversion equipment by significantly reducing losses
- Capable of high-frequency operation allowing for reduced magnetic filter size
- Available in a full line-up covering 1200V, 1700V, and 3300V ranges
- Compatible with previous Si-IGBT modules and packages

*Fuji Electric Hybrid SiC modules were applied in the traction converters on the N700 Series Shinkansen (a joint development with Central Japan Railway Company), and the test run for practical use has been successfully completed.

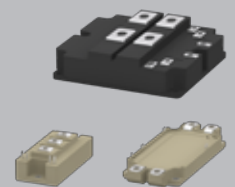

Package (typical examples)

Applications: General motor drives
UPS, PCS, and etc



1. Significant Loss Reduction

Significantly reduces diode switching loss and IGBT turn-on loss, while also contributing to substantial energy savings in power converters.

Reduce total device loss by 28%, when compared with one of our conventional inverters using Si modules*1.

SiC-SBD wafer

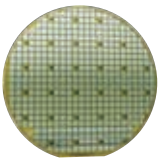

2-Pack Hybrid SiC module

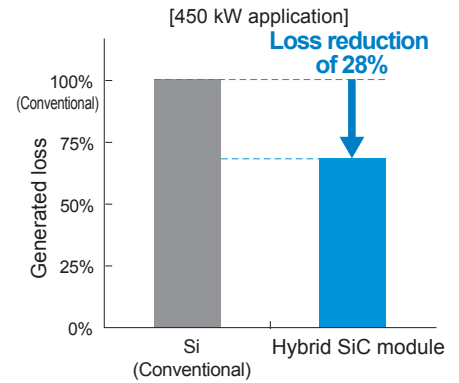
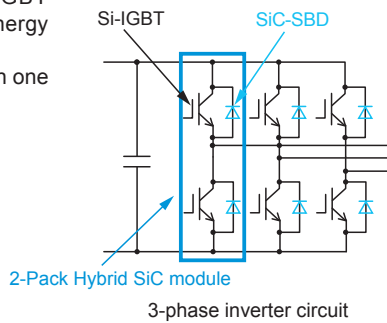
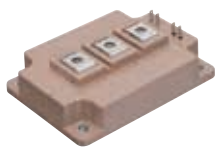

2. Higher Output and Smaller Footprint

Capable of high-frequency operation and contributes to the miniaturization of peripheral components such as filters allowing for space-savings for equipment.

Capable of higher output at the same loss and size as conventional products.



Enable capacity expansion from 315 kW to 450 kW for Fuji Electric's inverters*1 without changing the equipment size.

The resultant capacity expansion makes it possible to reduce the number of installed units.

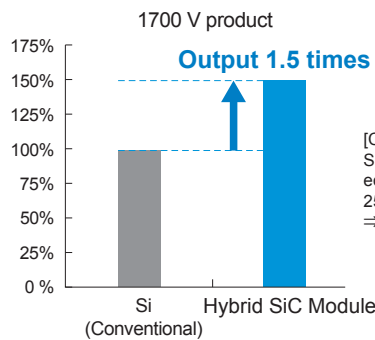

Reduce 2 units to 1 unit

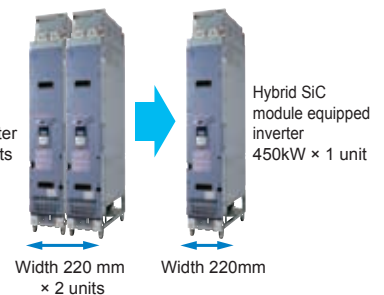

Product lineup (planned) 1200V/1700V/3300V

V _{CES}	PKG	100A to 1000A	1000A or more
1200V	2-Pack	200A, 300A, 300A, 450A, 600A	
1700V	2-Pack	400A, 550A	
3300V	1-Pack		1200A, 1800A

*1 "FRENIC-VG Series Stack Type (690 V Series)" large capacity inverter

⚠ Safety Precautions

- * Before using this product, read the "Instruction Manual" and "Specifications" carefully, and consult with the retailer from which you purchased this product as necessary to use this product correctly.
- * The product must be handled by a technician with the appropriate skills.

Fuji Electric Co., Ltd.

URL www.fujielectric.com/products/semiconductor/
Gate City Ohsaki, East Tower, 1-11-2, Ohsaki, Shinagawa-ku, Tokyo 141-0032, Japan Tel:+81-3-5435-7156

- Fuji Electric Hong Kong Co., Ltd. Unit 1601-03 & 05, 16/F., Tower II, Grand Century Place, No. 193 Prince Edward Road West, Mongkok, Kowloon, Hong Kong Tel: +852-2664-8699
- Fuji Electric Taiwan Co., Ltd. 10F. No.168, Song Jiang Road, Taipei, Taiwan Tel: +886-2-2515-1820
- Fuji Electric Asia Pacific Pte. Ltd. 151 Lorong Chuan, #03-01/01A, New Tech Park, SINGAPORE 556741 Tel: +65-6533-0014
- Fuji Electric India Private Ltd. 119(Part), 120, 120A, Electrical and Electronics Industrial Estate, Perungudi, Chennai - 600096, Tamil Nadu, India Tel: +91-44-40004200
- Fuji Electric Corp. of America 50 Northfield Avenue Edison, NJ 08837, USA Tel: +1-732-560-9410
- Fuji Electric Europe GmbH Goethering 58, 63067 Offenbach am Main, F.R. GERMANY Tel: +49-69-6690290

2021-8 FOLS PDF

The contents of this document are subject to change without notice.