

Green mode IC FA8A94N/95N Power supply design example : 19V/65W

Reference Design

1. Overview

This document describes the design example of flyback converter using the green mode PWM IC FA8A94N/95N. The input is universal (90Vac to 264Vac) and the output is 19V/65W.

FA8A84N/85N/94N/95N is a current mode type switching power supply control IC possible to drive a power MOSFET directly. Despite of a small package with 8 pins, it has a lot of functions and it is best suited for power saving at the light load and decreasing external parts. Moreover it enables to realize a reduced space and a high cost-performance power supply.

2. Features

■ Realization of low standby power

- Built-in discharge function for AC input filter capacitor (XCAP). (Reduce loss of the discharge resistor)
- Integrated frequency decrease function improves efficiency in the middle-load region. (Frequency decrease start point is adjustable based on the settings of mounted parts.)
- Intermittent operation (burst operation) system adopted for light load operation achieves low standby power. (Burst operation start point is adjustable based on the settings of mounted parts.)
- Switching is allowed between normal operation mode and power-off mode. In power-off mode, lower standby power is ensured.
- Built-in 650V high voltage startup circuit.

■ Various Protection are built in.

- Overload protection (Auto recovery, Latch)
- Integrated function of correcting overload detection level depending on AC input voltage (Correction amount is adjustable based on the settings of externally mounted parts.)
- Integrated latch-off function based on external signals, overvoltage protection function, low-voltage prevention function, and overheat protection function
- Internal Soft-Start
- The lowest frequency is set to 26 kHz to prevent operation at audible frequency under light load.

■ Switching frequency jitter function realize low EMI.

■ Internal DSS (Dynamic Self Supply)

■ Drive circuit for MOSFET: -0.5A(sink)/0.5A(source)



3. Application circuit

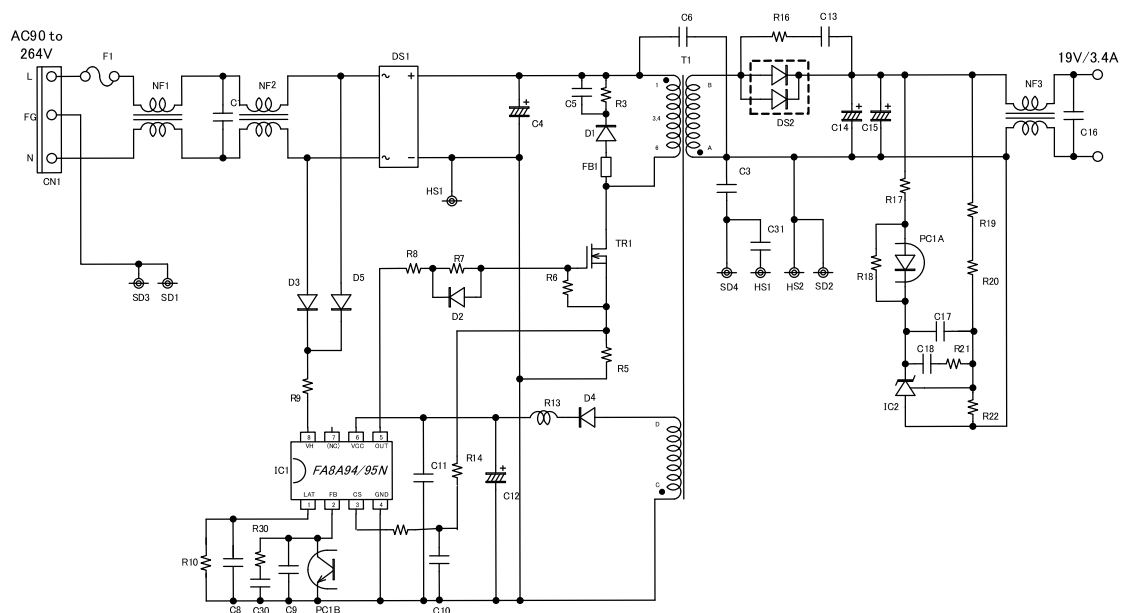

4. Specifications of the Power supply

Item	Value	Unit
Input voltage	90 to 264	Vac
Output voltage	19	Vdc
Output current	3.4	A

5. Efficiency

Load (%)	25	50	75	100	Ave.
Efficiency at 100Vac (%)	88.7	87.8	87.5	87.7	87.9
Efficiency at 230Vac (%)	87.7	87.2	87.5	86.6	87.2

Measured using cable with a length (L) = 1.9m and a diameter (Φ) = 1.1mm.

Input voltage	100Vac	230Vac
Input power at NO Load	28.3mW	27.4mW
Over Current Protect	5.3A	6.5A

6. Characteristics curves

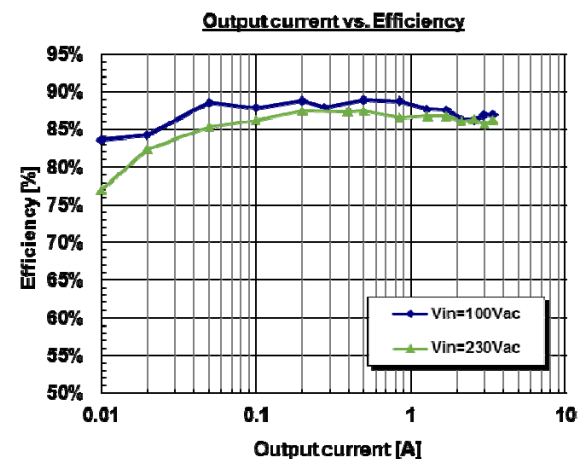
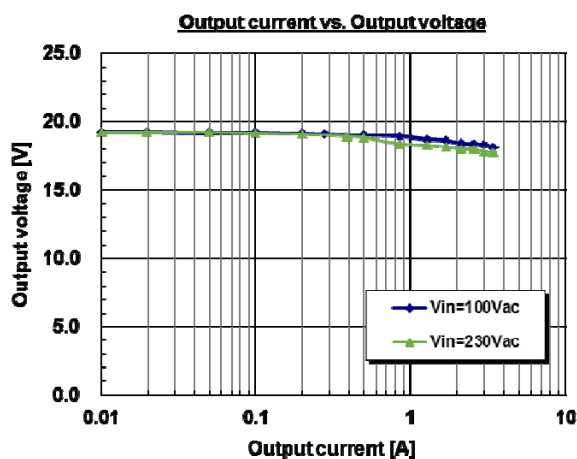
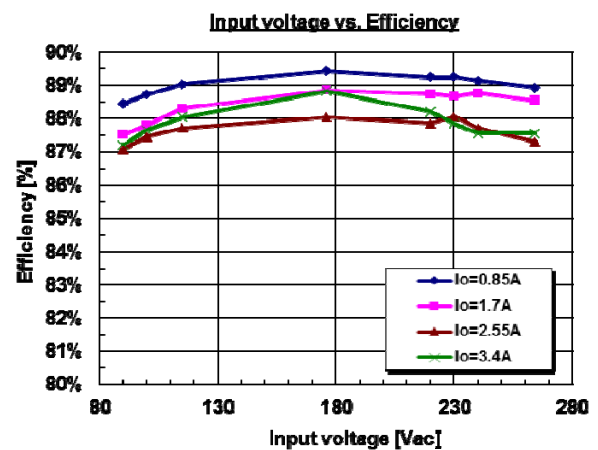
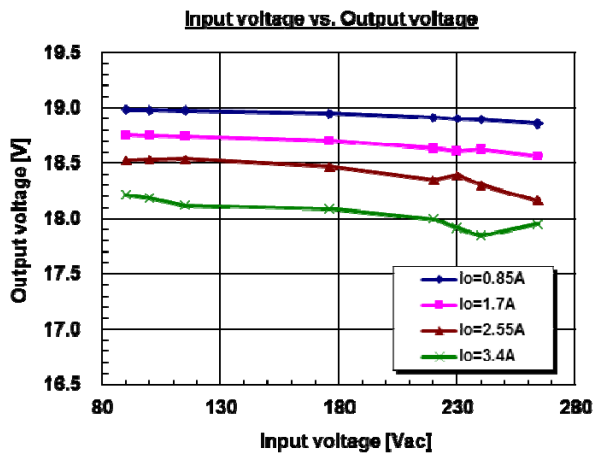

6. Characteristics curves

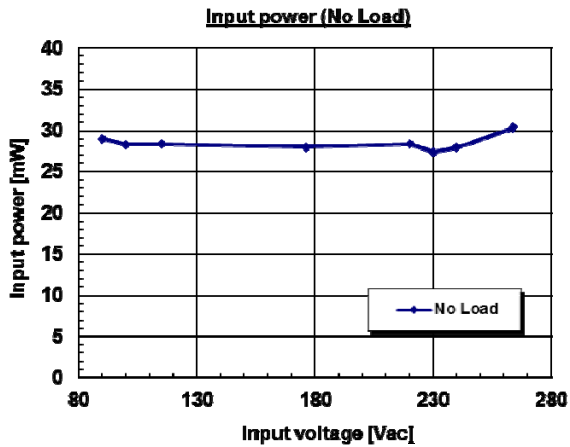
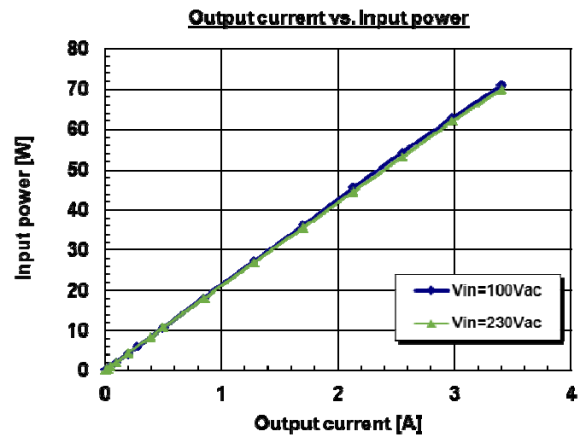
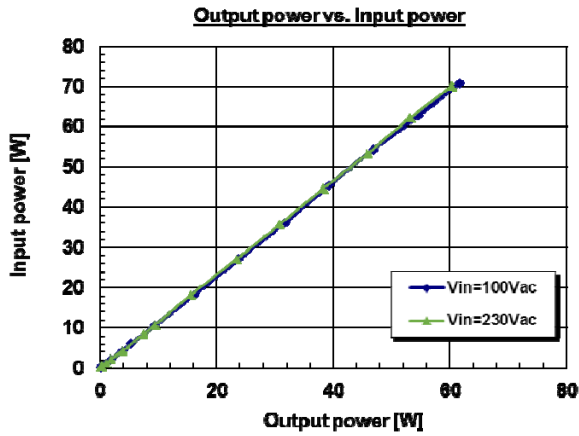
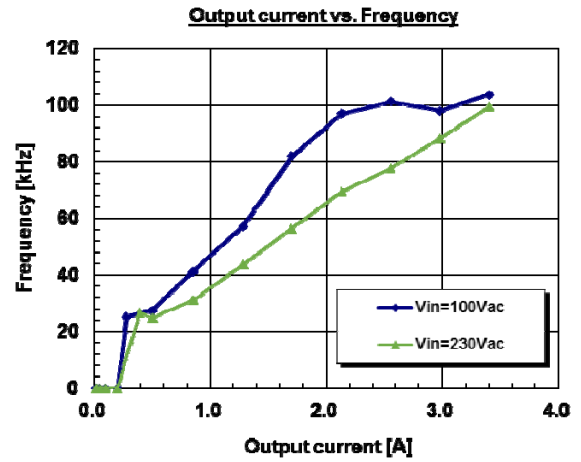
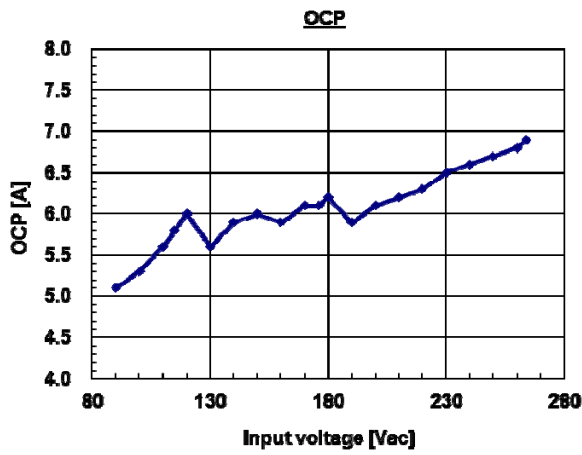

7. Switching waveforms

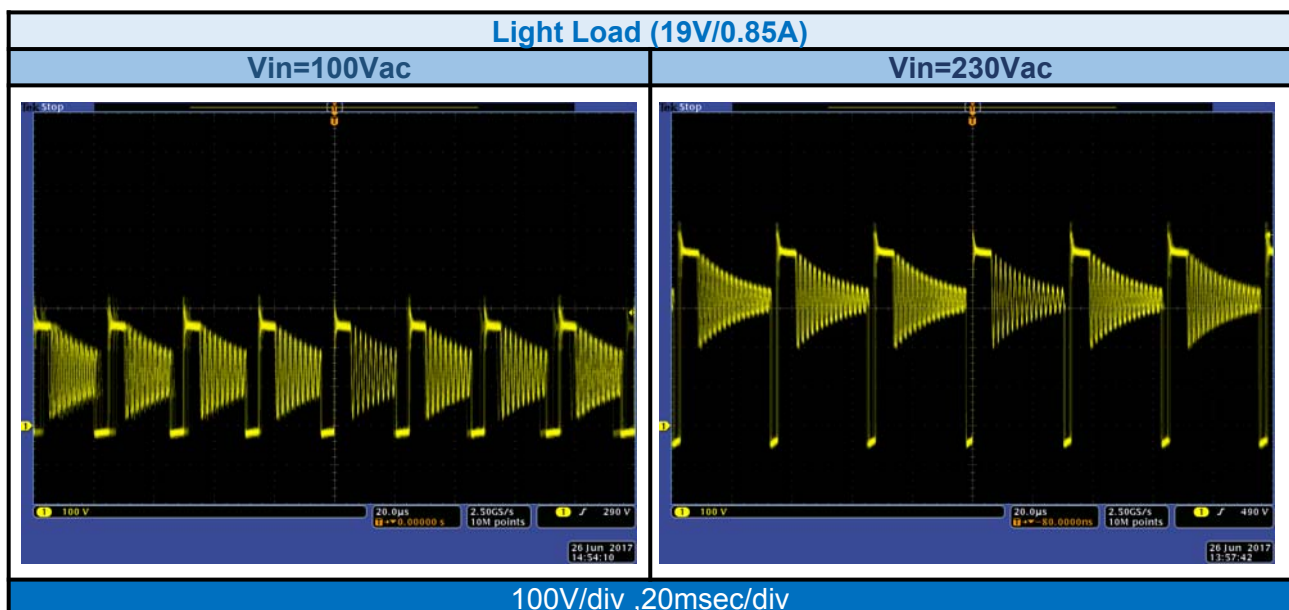
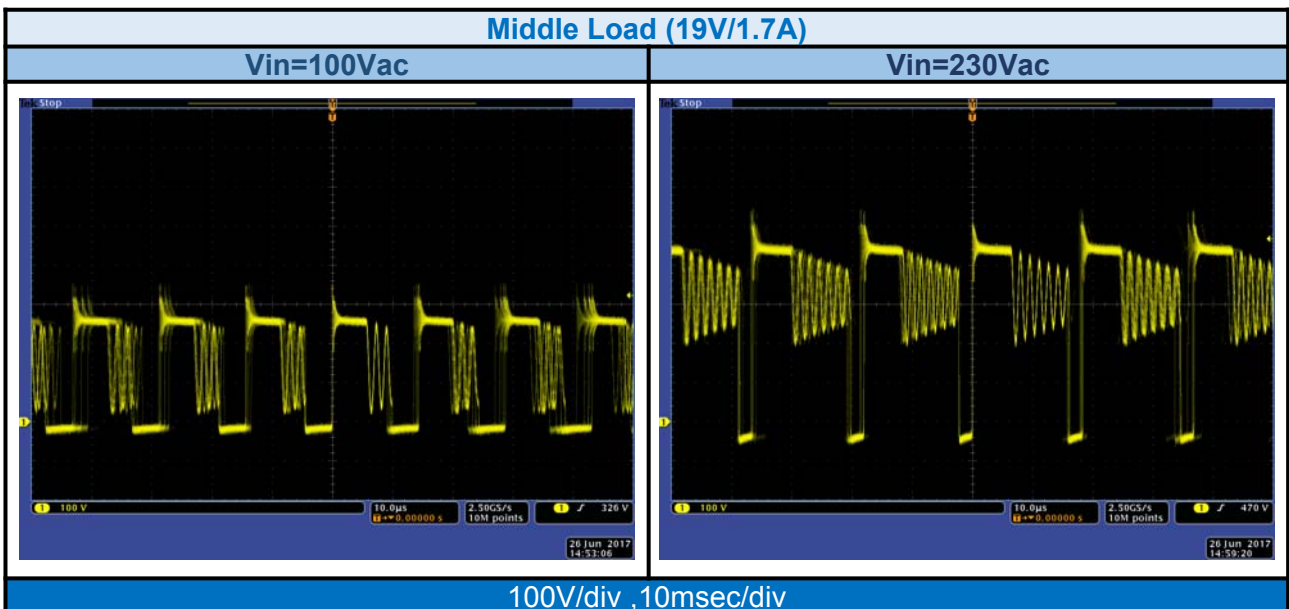
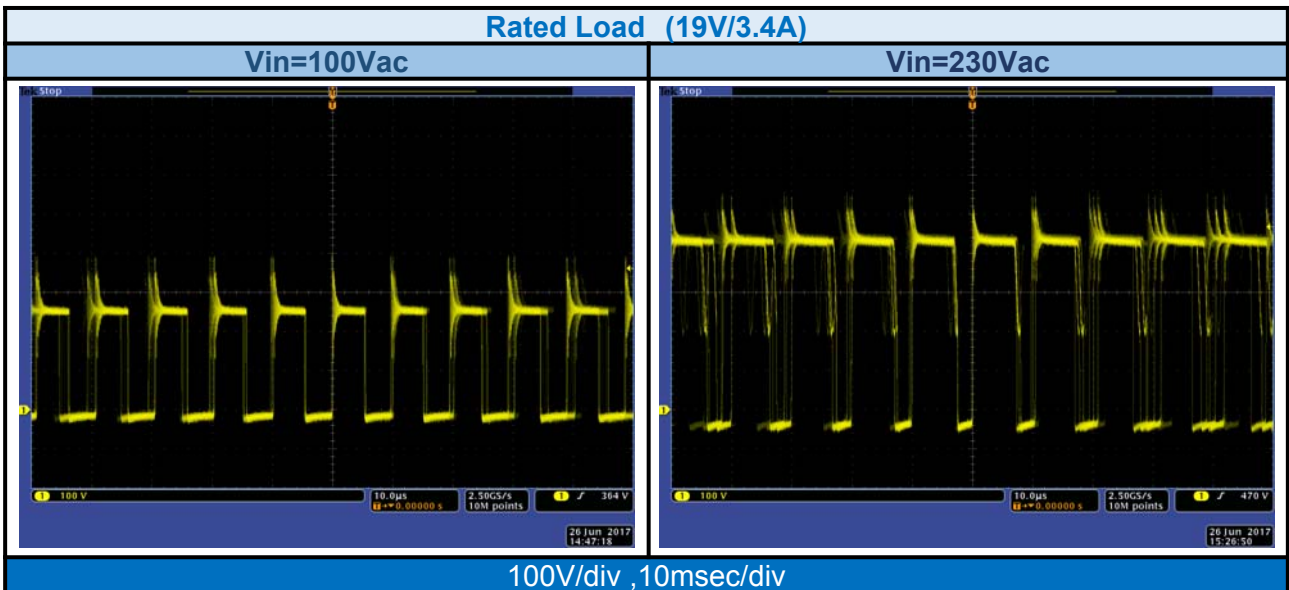

7. Switching waveforms

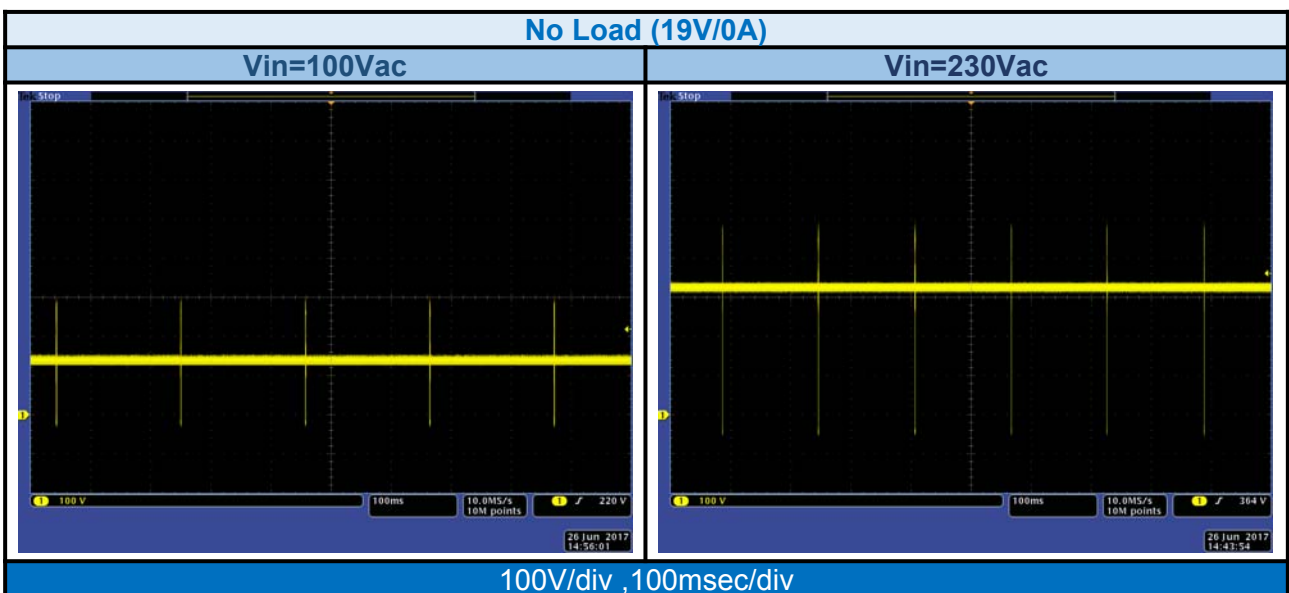
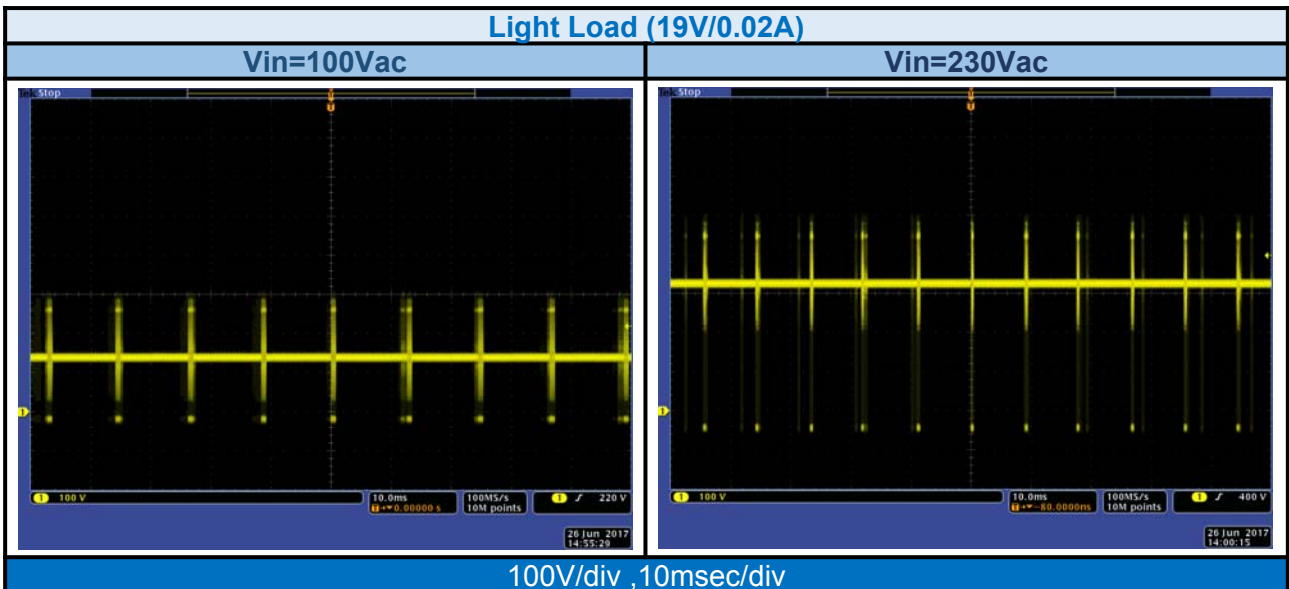
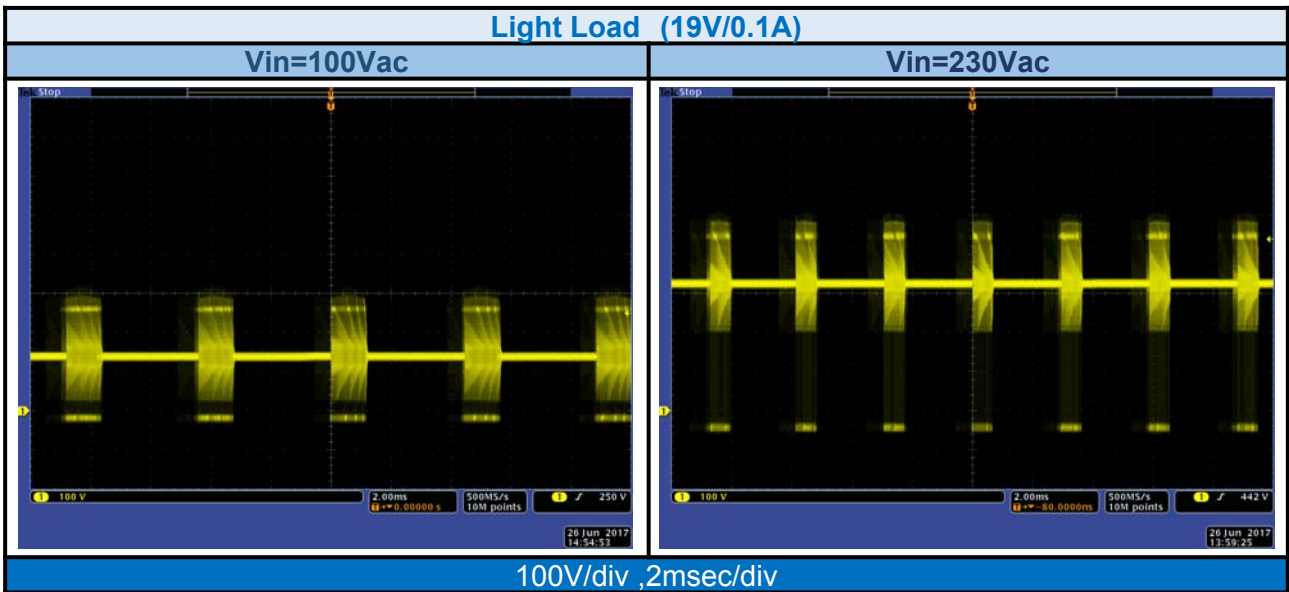

FA8A94N/95N Reference Design
8. Bill of material

Component	Item	Value	Part. No	Maker	Note
T1	Transformer		Y11FE100kHz		RM10
NF1	Ring core		E04RA140070100	SEIWA ELECTRIC	Φ0.6 11turns
NF2	Noise filter		ADR18SH02-120S	UENO	
NF3	Ring core		E04RC100505	SEIWA ELECTRIC	Φ0.6 5turns
FB1	Ferrite beads		HF70BB2.5X2.2X0.8	TDK	
C1	Film capacitor	275V, 0.33uF	LE334	OKAYA ELECTRIC	Class X2
C4	Electrolytic capacitor	400V, 120uF	UCY2G121MHD	NICHICON	
C5	Film capacitor	630V, 3300pF	DESD33A332KA3B	MURATA	
C6	Ceramic capacitor	250V, 4700pF	DE1E3KX472MN5AA01	MURATA	
C8	Chip ceramic capacitor	50V, 3300pF	GRM1853U1H332JA44D	MURATA	SMD
C9	Chip ceramic capacitor	50V, 1000pF	GRM1882C1H102JA01D	MURATA	SMD
C18	Chip ceramic capacitor	50V, 0.01uF	GRM188B11H103KA01D	MURATA	SMD
C10	Chip ceramic capacitor	50V, 100pF	GRM1882C1H101JA01D	MURATA	SMD
C11,16	Chip ceramic capacitor	50V, 0.1uF	GRM188R11H104KA93D	MURATA	SMD
C12	Electrolytic capacitor	50V, 22uF	50ME22AX	SUNCON	
C13	Chip ceramic capacitor	630V, 1000pF	GRM31A7U2J102JW31D	MURATA	SMD
C14,15	Electrolytic capacitor	25V, 680uF	25ME680WX	SUNCON	
C17	Chip ceramic capacitor	50V, 470pF	GRM1882C1H471JA01D	MURATA	
C30	Chip ceramic capacitor	50V, 2200pF	GRM1853U1H222JA44D	MURATA	
C31	Ceramic capacitor	250V, 470pF	DE1B3KX471KA4BL01	MURATA	
R3	Metal oxide film resistor	100KΩ, 2W	RSFS2ST-52 100KΩJ	TAIYO DENKI	
R16	Metal oxide film resistor	10Ω, 2W	RSFS2ST-52 10ΩJ	TAIYO DENKI	
R5	Metal oxide film resistor	0.18Ω, 2W	MOSX2CT52AR18J	KOA	Radial
R6	Chip resistor	10KΩ, 1/8W	RMC1/10 103FTP	KAMAYA ELECTRIC	2125
R7	Chip resistor	300Ω, 1/4W	RMC1/8 301JTP	KAMAYA ELECTRIC	3216
R8	Chip resistor	10Ω, 1/4W	RMC1/8 100JTP	KAMAYA ELECTRIC	3216
R9	Chip resistor	5.6KΩ, 1/4W	RMC1/8K562FTP	KAMAYA ELECTRIC	3216
R10	Chip resistor	270KΩ, 1/10W	RMC1/16 274FT	KAMAYA ELECTRIC	1608
R13	Chip inductor	4.7uH, 240mA	LB2518T4R7M	TAIYO YUDEN	2518
R14	Chip resistor	4.3KΩ, 1/10W	RMC1/16 432FTP	KAMAYA ELECTRIC	1608
R17	Chip resistor	3KΩ, 1/8W	RMC1/10 302FTP	KAMAYA ELECTRIC	2125
R20	Chip resistor	11KΩ, 1/10W, 1%	RMC1/16 113FTP	KAMAYA ELECTRIC	1608
R21	Chip resistor	10KΩ, 1/10W	RMC1/16 103FTP	KAMAYA ELECTRIC	1608
R18	Chip resistor	8.2KΩ, 1/10W	RMC1/16 822FTP	KAMAYA ELECTRIC	1608
R19	Chip resistor	150KΩ, 1/8W	RMC1/10 154FT	KAMAYA ELECTRIC	2125
R22	Chip resistor	24KΩ, 1/10W	RMC1/16 243FTP	KAMAYA ELECTRIC	1608
R30	Chip resistor	10KΩ, 1/10W	RMC1/16 103FTP	KAMAYA ELECTRIC	1608
JP9,10	Chip resistor	0Ω	RMC1/10 JP1P	KAMAYA ELECTRIC	2125
DS1	Diode bridge	600V, 2A	D2SB60A-7000	SHINDENGEN	
DS2	Diode	120V, 20A	YG865C12R	FUJI ELECTRIC	
D1	Diode	1KV, 0.5A	UF4007-E3/54	Vishay	
D2,4	Chip diode	200V, 1A	CRH01(T5L,TEMQ)	TOSHIBA	
D3,5	Chip diode	600V, 0.7A	CRF03(T5L,TEMQ)	TOSHIBA	
TR1	MOSFET	600V, 11A	FMV11N60ES	FUJI ELECTRIC	
IC1	Power supply control IC		FA8A94N/95N	FUJI ELECTRIC	
IC2	Shunt regulator		HA17432HUP-E	RENESAS	
PC1	Photocoupler		TLP781F(GR,F)	TOSHIBA	
F1	Fuse	250V, 3.15A	SST 250V 3.15A	NIPPON SEISEN	

FA8A94N/95N Reference Design
9. Transformer specifications

Bobbin	BRM10-7112SDFR
Core	PC40RM10Z-1
Gap	Approx. 0.472mm(center gap): Optimizing center gap to 377uH±10%
Inductance	1pin~6pin 377uH±10%
Safety Rule	UL·CSA·IEC

Winding order	Layer	Wire material and size	Winding Turns	Winding starting position	winding ending position	Winding type	Insulation tape		Remark
							Barrier tape		
1	NS1-1	TEX Φ0.35×4	7	A	B	Solenoid	up: 0mm/down: 0mm	10mm 1T	2layers
2	NP1-1	UEW Φ0.25×3	19	1	3	Solenoid	up: 0mm/down: 0mm	10mm 1T	2layers
3	NS1-2	TEX Φ0.35×4	7	A	B	Solenoid	up: 0mm/down: 0mm	10mm 1T	2layers
4	NP2	UEW Φ0.2×1	7	C	D	Space	up: 0mm/down: 0mm	10mm 1T	
5	NP1-2	UEW Φ0.25×3	19	4	6	Solenoid	up: 0mm/down: 0mm	10mm 3T	2layers

	Insulation Resistance (MΩ)	Withstand Voltage (kV) 1min.
Np : Ns	10	3
Pri. Core	10	0.5
Sec. core	10	3

Pin Pattern (Top view)

C and D: 45mm wire from top of the bobbin

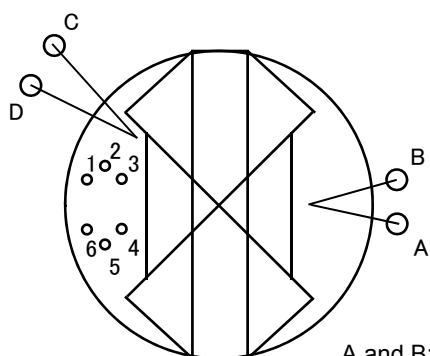

A and B: 15mm wire from bottom of the bobbin

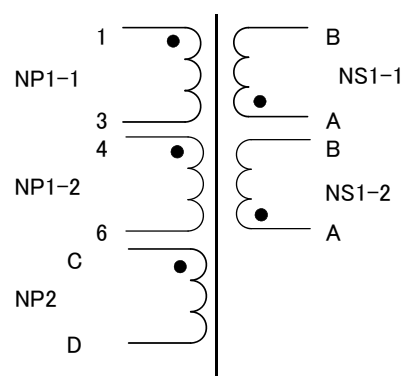
Connection

3 pin and 4 pin are connected on the PCB

Start of the winding is black marked.
Flying wire C and D are applied silicone sleeve.

Notice

1. The contents of this note (Product Specification, Characteristics, Data, Materials, and Structure etc.) were prepared in June 2017. The contents will subject to change without notice due to product specification change or some other reasons. In case of using the products stated in this document, the latest product specification shall be provided and the data shall be checked.
2. The application examples in this note show the typical examples of using Fuji products and this note shall neither assure to enforce the industrial property including some other rights nor grant the license.
3. Fuji Electric Co., Ltd. is always enhancing the product quality and reliability. However, semiconductor products may get out of order in a certain probability. Measures for ensuring safety, such as redundant design, spreading fire protection design, malfunction protection design shall be taken, so that Fuji Electric semiconductor product may not cause physical injury, property damage by fire and social damage as a result.
4. Products described in this note are manufactured and intended to be used in the following electronic devices and electric devices in which ordinary reliability is required:
 - Computer - OA equipment - Communication equipment (Pin) - Measuring equipment
 - Machine tool - Audio Visual equipment - Home appliance - Personal equipment
 - Industrial robot etc.
5. Customers who are going to use our products in the following high reliable equipments shall contact us surely and obtain our consent in advance. In case when our products are used in the following equipment, suitable measures for keeping safety such as a back-up-system for malfunction of the equipment shall be taken even if Fuji Electric semiconductor products break down:
 - Transportation equipment (in-vehicle, in-ship etc.) - Communication equipment for trunk line
 - Traffic signal equipment - Gas leak detector and gas shutoff equipment
 - Disaster prevention/Security equipment - Various equipment for the safety.
6. Products described in this note shall not be used in the following equipments that require extremely high reliability:
 - Space equipment - Aircraft equipment - Atomic energy control equipment
 - Undersea communication equipment - Medical equipment.
7. When reprinting or copying all or a part of this note, our company's acceptance in writing shall be obtained.
8. If obscure parts are found in the contents of this note, contact Fuji Electric Co., Ltd. or a sales agent before using our products. Fuji Electric Co., Ltd. and its sales agents shall not be liable for any damage that is caused by a customer who does not follow the instructions in this cautionary statement.

- The contents will subject to change without notice due to product specification change etc.
- Application examples and component in this sheet is for the purpose of assisting in the design. Therefore, This sheet has not been made in consideration of the margin.
- Before using, Please design in consideration of the parts variation and use condition.