

Green mode PWM IC FA8A70N series

Power supply design example : 5V/15W

Reference Design

1. Overview

This document describes the design example of flyback converter using the green mode PWM IC FA8A70N series. The input is universal (90Vac to 264Vac) and the output is 5V/15W.

This IC can improve efficiency of middle load to reduce the switching frequency according to the load. Furthermore, it can realize low standby power to change the burst mode switching at the light load.

2. Features

■Realization of low standby power

- Built-in discharge function for AC input filter capacitor (XCAP). (Reduce loss of the discharge resistor)
- Integrated frequency decrease function improves efficiency in the middle-load region. (Frequency decrease start point is adjustable based on the settings of mounted parts.)
- Intermittent operation (burst operation) system adopted for light load operation achieves low standby power. (Burst operation start point is adjustable based on the settings of mounted parts.)
- Switching is allowed between normal operation mode and power-off mode. In power-off mode, lower standby power is ensured.
- Built-in 500V high voltage startup circuit.

■Various Protection are built in.

- Overload protection (Auto recovery, Latch)
- Integrated function of correcting overload detection level depending on AC input voltage (Correction amount is adjustable based on the settings of externally mounted parts.)
- Integrated latch-off function based on external signals, overvoltage protection function, low-voltage prevention function, and overheat protection function
- Internal Soft-Start
- The lowest frequency is set to 25 kHz to prevent operation at audible frequency under light load.

■Switching frequency jitter function realize low EMI.

■ Internal DSS (Dynamic Self Supply)

■ Drive circuit for MOSFET: -0.5A(sink)/0.5A (source)



3. Application circuit

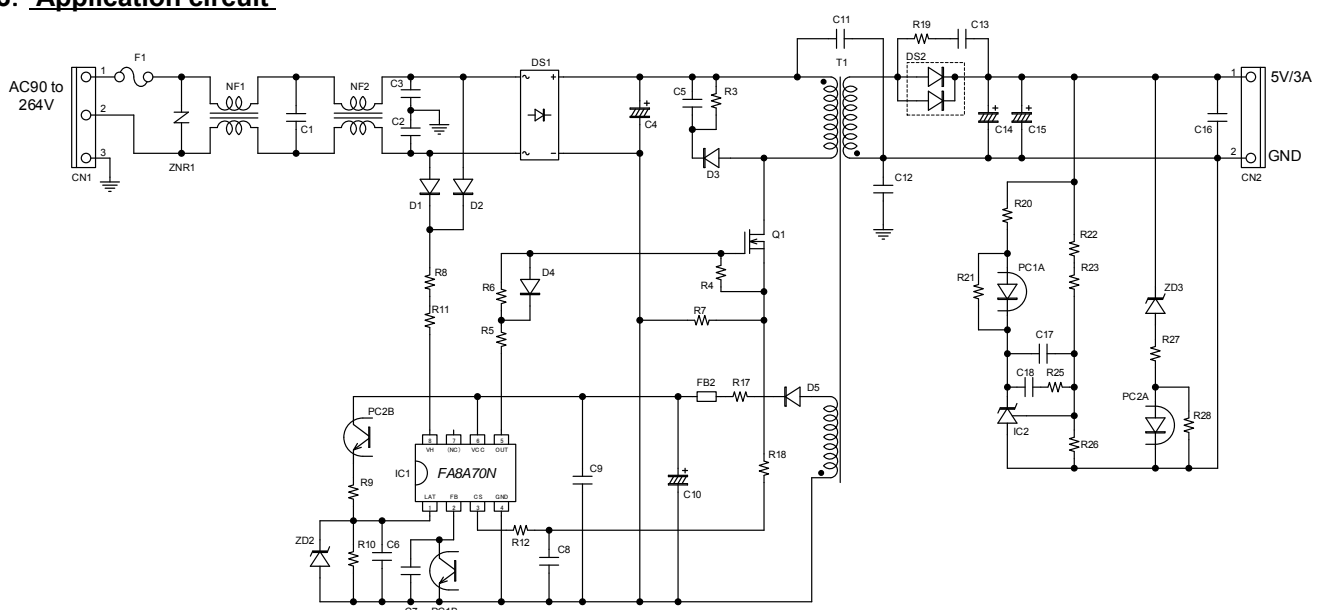

FA8A70N Reference Design

4. Specifications of the Power supply

Item	Value	Unit
Input voltage	90 to 264	Vac
Output voltage	5	Vdc
Output current	3	A

5. Efficiency

Item		100Vac	230Vac
Efficiency	Typ Load(3A)	80.5%	79.5%
Input power at NO Load		12.5mW	25.6mW
OLP		3.93A	3.88A

6. Characteristics curves

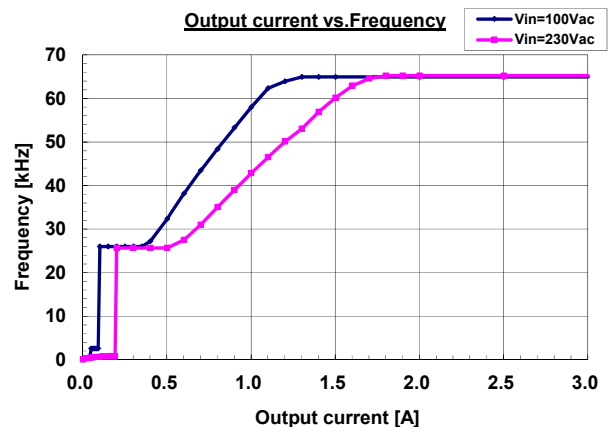
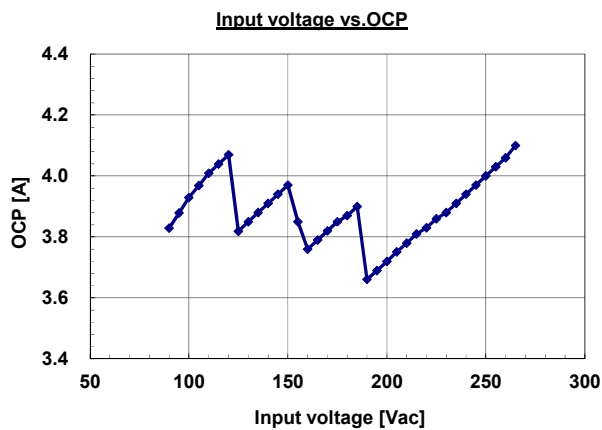
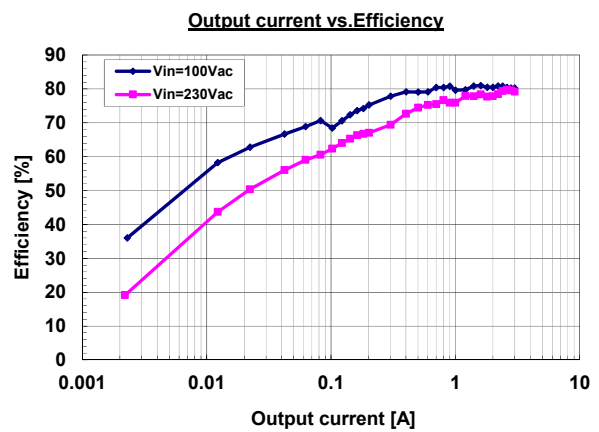
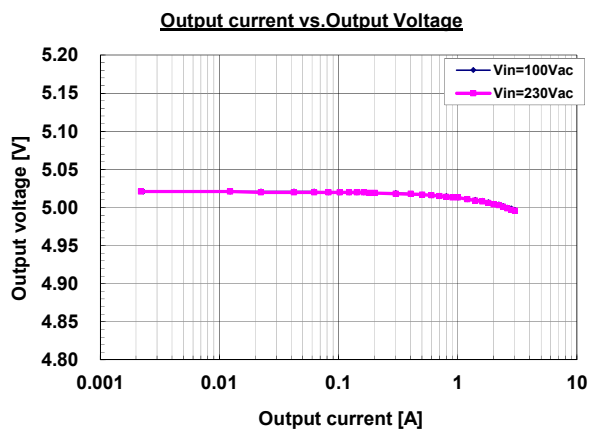
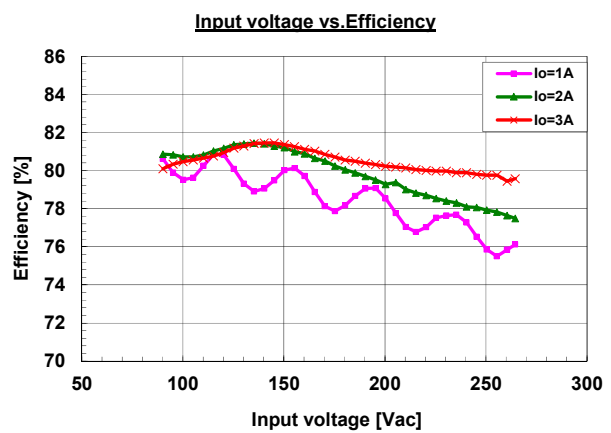
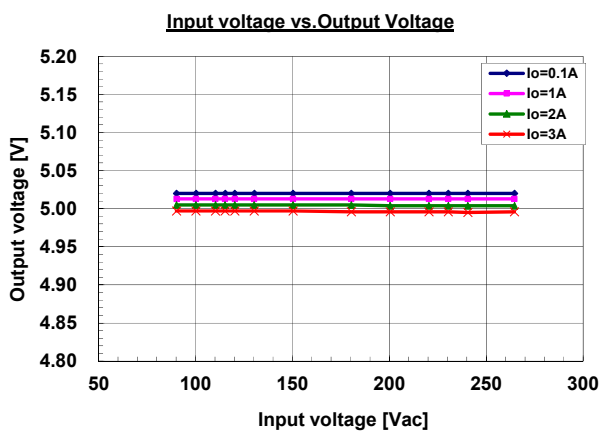

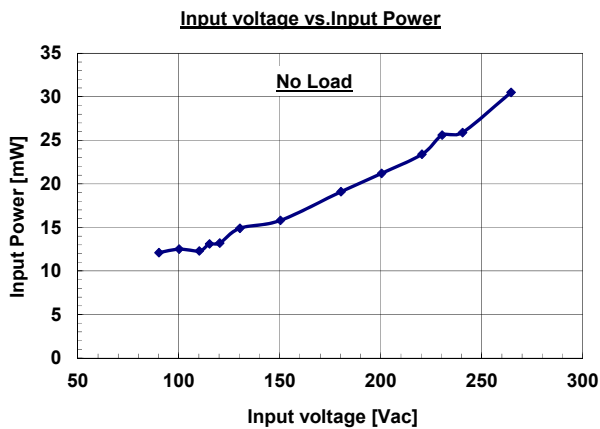
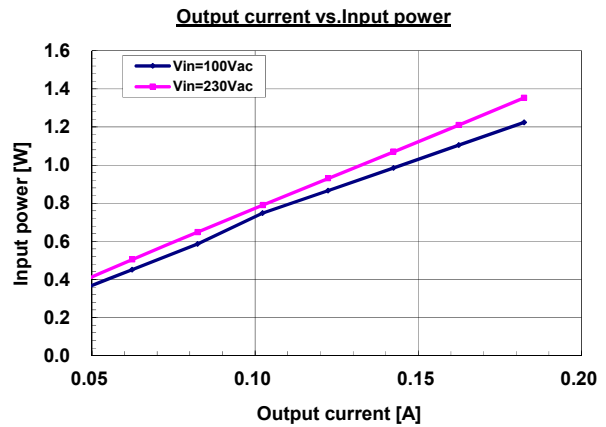
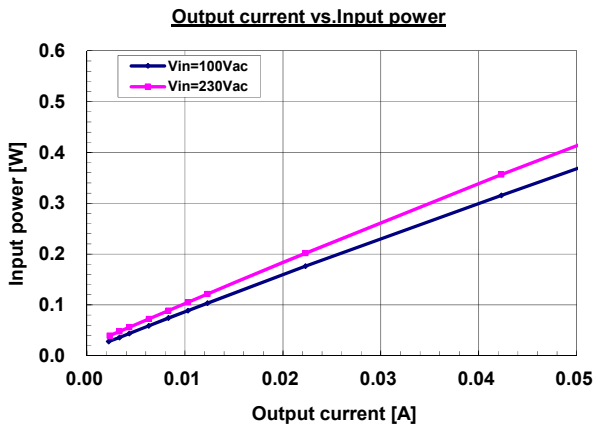
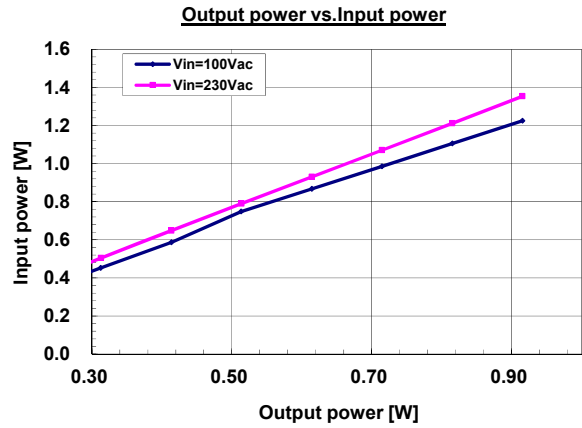
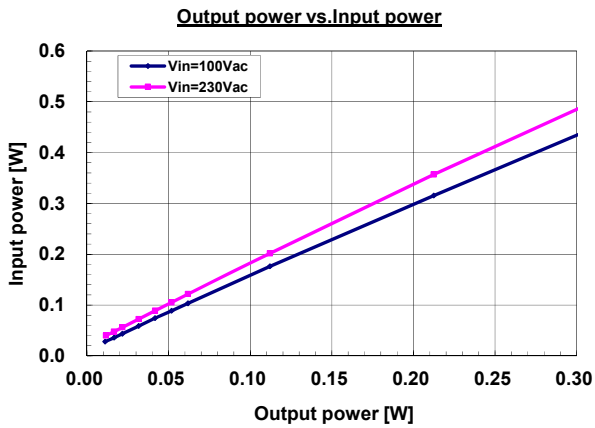

FA8A70N Reference Design

- 7. Switching waveforms (Vds)
- ✓ **Rated Load (5V/3A)**

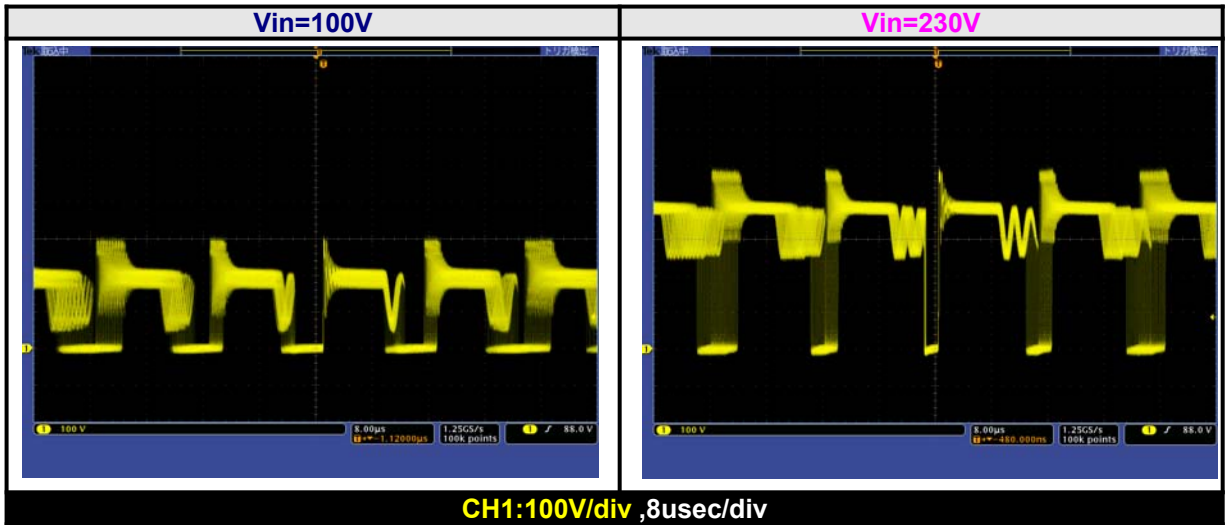

- ✓ **Middle Load (5V/1A)**

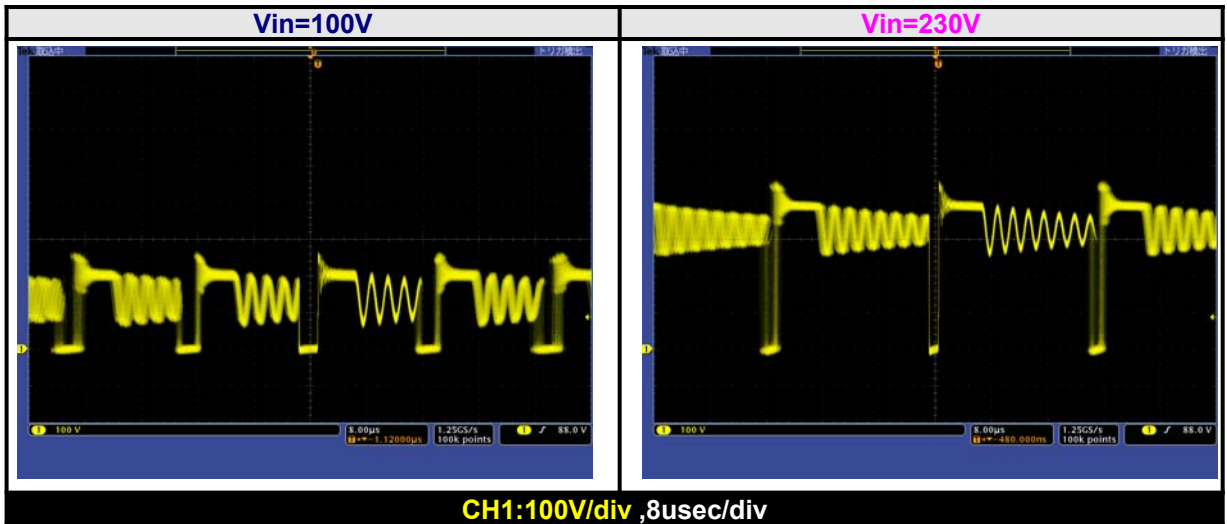

- ✓ **Light Load (5V/0.1A)**

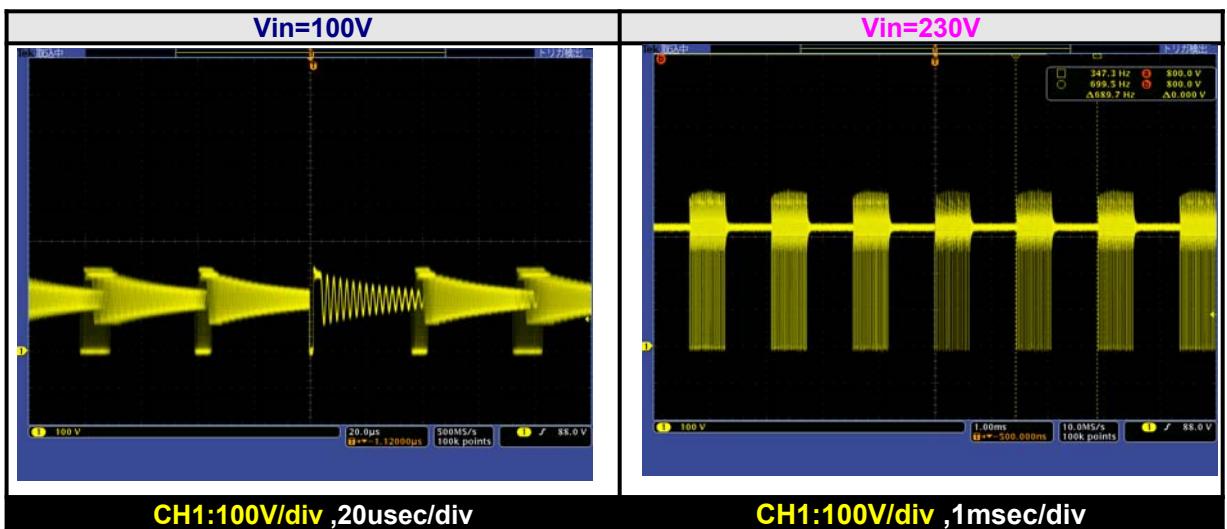

FA8A70N Reference Design

✓ Light Load (5V/0.02A)

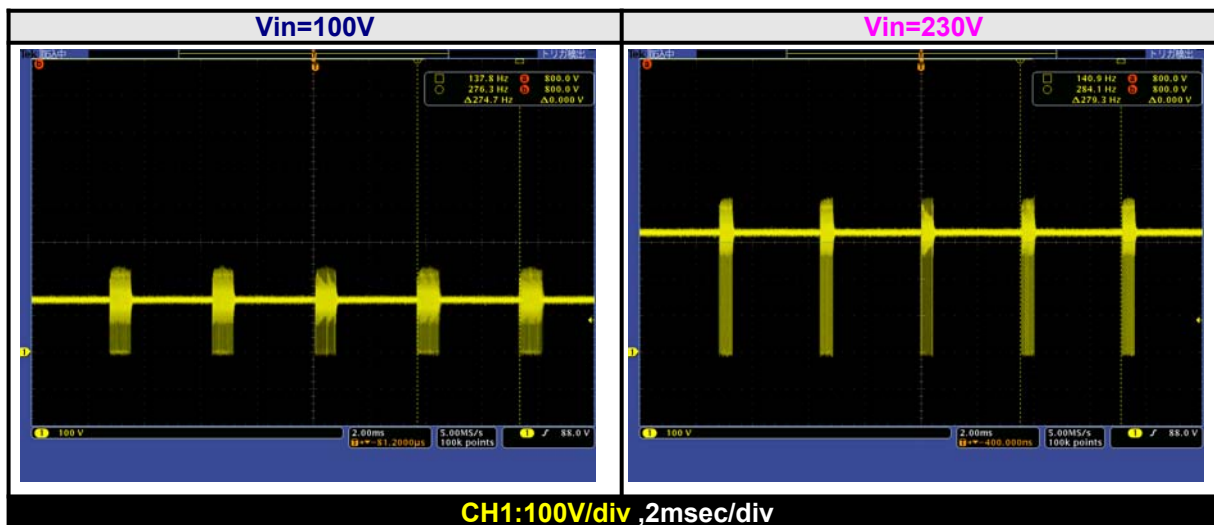

✓ No-Load (5V/0A)

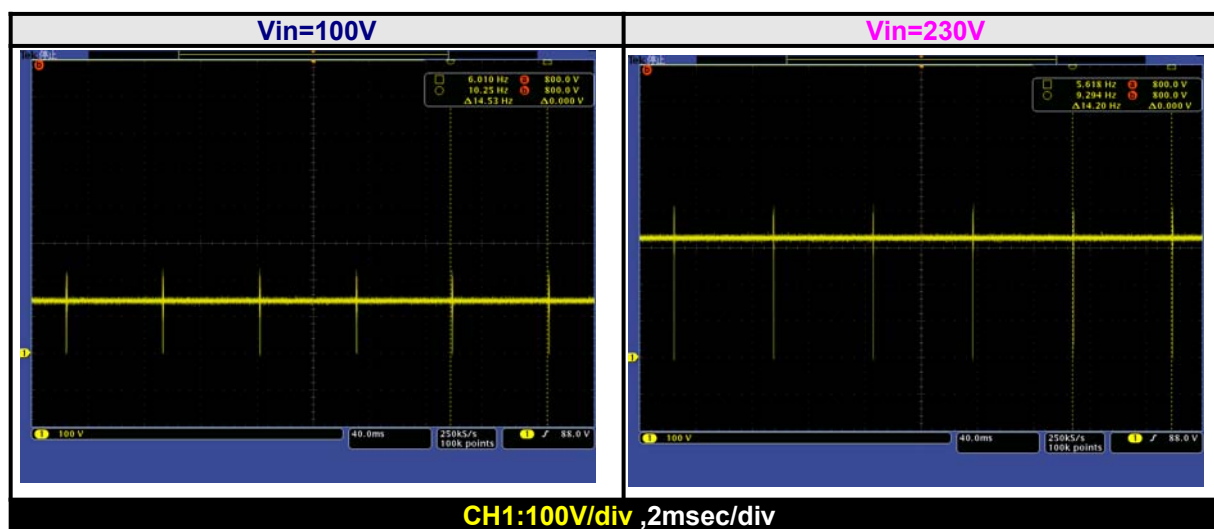

FA8A70N Reference Design
9. Bill of material

Component	Item	Value	Part. No	Maker	Note
T1	Transformer	Lp=635uH	ST13FE005-53-1		Np:Ns:Nps=62:5:13
NF1	Noise filter	4A,10uH	SFC-13R1-04100	SEKISHIN	
NF2	Noise filter	0.5A,13mH	PLA10AN1330R5D2	MURATA	
FB2	Bead		HF70BB3.5X5X1.3	TDK	
C1	Film capacitor	275V,0.47uF	LE474-M	OKAYA	
C2,3	Ceramic capacitor	250V,2200pF	DE1E3KX222M_L01	Murata	
C4	Electrolytic Capacitor	450V,33uF	UCS2W330MDH	Nichicon	
C5	Film capacitor	630V,0.01uF	ECQE6103KF	Panasonic	
C6	Ceramic capacitor	50V,220pF	GRM1882C1H221J	MURATA	
C7	Ceramic capacitor	50V,1000pF	GRM188B11H102K	MURATA	
C8	Ceramic capacitor	50V,100pF	GRM1882C1H101J	MURATA	
C9,C16	Ceramic capacitor	50V,0.1uF	GRM188R11H104K	MURATA	
C10	Electrolytic Capacitor	50V,47uF	50ME47AX	SUN CON	
C11	Ceramic capacitor	250V,4700pF	DE1E3KX472M_L01		
C12	Film capacitor	400V,0.1uF	ECQE4104KF	Panasonic	
C13	Ceramic capacitor	1KV,1000pF	DEHR33A102K	Murata	
C14,15	Electrolytic Capacitor	10V,3300uF	10ME3300WA	SUN CON	
C18	Ceramic capacitor	50V,0.01uF	GRM188B11H103K	MURATA	
R3	Fixed Metal Film Resistors	100kΩ,2W			
R4,R21,R28	Resistor	10KΩ,1/8W			
R5	Resistor	22Ω,1/4W			
R6	Resistor	100Ω,1/4W			
R7	Fixed Metal Film Resistors	0.51Ω,2W			
R8,R11	Resistor	4.7KΩ,1/4W			
R9,20	Resistor	330Ω,1/8W			
R10	Resistor	160kΩ,1/8W			
R12	Resistor	1kΩ,1/8W			
R17	Resistor	1Ω,1/4W			
R18	Resistor	470Ω,1/8W			
R19	Fixed Metal Film Resistors	10Ω,2W			
R22,26	Resistor	47kΩ,1/8W			
R23	Resistor	0Ω,1/8W			
R25	Resistor	47KΩ,1/8W			
R27	Resistor	68Ω,1/8W			
DS1	Diode	600V,1A	S1WB(A)60-7101	Shindengen	
DS2	Diode	45V,20A	YG865C04R	Fuji	
D1,D2	Diode	600V,0.7A	CRF03	Toshiba	
D3	Diode	1KV,0.5A	UF4007	Vishay	
D4,5	Diode	200V,1A	CRH01	Toshiba	
ZD2	Zener Diode	2.7V,200mW	HZU2.7B1	RENESAS	
ZD3	Zener Diode	5.6V,200mW	HZU5.6B2	RENESAS	
Q1	Nch-MOSFET	600V,11A	FMV11N60ES	FUJI	TO220F
IC1	PWM-IC		FA8A71N	FUJI	
IC2	IC		HA17432HUP	RENESAS	
PC1,PC2	Photo transistor		TLP781F	Toshiba	
F1	Fuse	250V,1.6A	SLT250V 1.6A		
ZNR1	Varistor		ERZV10D471	Panasonic	

10. Transformer specifications

Winding order	layer	Wire type	turn	Pin	
				Start	Finish
1	NP1-1	UEWφ0.35	62	1	2
2	NS1-1	TEXφ0.5×2	5	5	7
3	NP2	UEWφ0.3	13	4	3
4	NS1-2	TEXφ0.5×2	5	6	8
5	NP1-2	UEWφ0.35	62	1	2

bobbin	BEER-25.5-118CPFR
core	PC40EER24.5-Z
Gap	0.2mm(side gap)
inductance	1pin to 2pin 635uH±10%

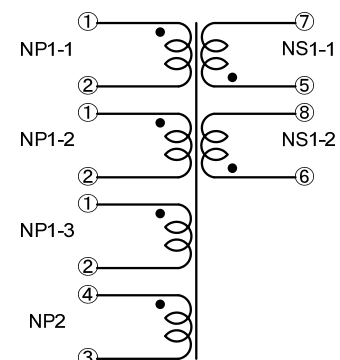

Notice

1. The contents of this note (Product Specification, Characteristics, Data, Materials, and Structure etc.) were prepared in Mar, 2019. The contents will subject to change without notice due to product specification change or some other reasons. In case of using the products stated in this document, the latest product specification shall be provided and the data shall be checked.
2. The application examples in this note show the typical examples of using Fuji products and this note shall neither assure to enforce the industrial property including some other rights nor grant the license.
3. Fuji Electric Co., Ltd. is always enhancing the product quality and reliability. However, semiconductor products may get out of order in a certain probability. Measures for ensuring safety, such as redundant design, spreading fire protection design, malfunction protection design shall be taken, so that Fuji Electric semiconductor product may not cause physical injury, property damage by fire and social damage as a result.
4. Products described in this note are manufactured and intended to be used in the following electronic devices and electric devices in which ordinary reliability is required:
 - Computer - OA equipment - Communication equipment (Pin) - Measuring equipment
 - Machine tool - Audio Visual equipment - Home appliance - Personal equipment
 - Industrial robot etc.
5. Customers who are going to use our products in the following high reliable equipments shall contact us surely and obtain our consent in advance. In case when our products are used in the following equipment, suitable measures for keeping safety such as a back-up-system for malfunction of the equipment shall be taken even if Fuji Electric semiconductor products break down:
 - Transportation equipment (in-vehicle, in-ship etc.) - Communication equipment for trunk line
 - Traffic signal equipment - Gas leak detector and gas shutoff equipment
 - Disaster prevention/Security equipment - Various equipment for the safety.
6. Products described in this note shall not be used in the following equipments that require extremely high reliability:
 - Space equipment - Aircraft equipment - Atomic energy control equipment
 - Undersea communication equipment - Medical equipment.
7. When reprinting or copying all or a part of this note, our company's acceptance in writing shall be obtained.
8. If obscure parts are found in the contents of this note, contact Fuji Electric Co., Ltd. or a sales agent before using our products. Fuji Electric Co., Ltd. and its sales agents shall not be liable for any damage that is caused by a customer who does not follow the instructions in this cautionary statement.

- The contents will subject to change without notice due to product specification change etc.
- Application examples and component in this sheet is for the purpose of assisting in the design. Therefore, This sheet has not been made in consideration of the margin.
- Before using, Please design in consideration of the parts variation and use condition.