

---

# FUJI IGBT Modules U Series

## Technical Documents

---

Power cycle capability .....	MT5Z02525c
RBSOA, SCSOA .....	MT5F13198
High current output-characteristics .....	MT5F13582
Short circuit current vs $V_{GE}$ characteristics .....	MT5F14993
2 in one-package module parallel connection application .....	MT5F14514
Switching loss, $dv/dt$ vs $C_{GE}$ , $R_G$ .....	MT5F14571
$-V_{GE}$ vs switching loss characteristics .....	MT5F13288
Dependence of blocking and junction temp. ....	MT5F13015
$V_{CES}$ vs $T_j$ characteristics .....	MT5F14432
$-di_c/dt$ vs $T_j$ characteristics .....	MT5F14433
Dynamic avalanche voltage vs $T_j$ characteristics .....	MT5F14434
Transient thermal impedance .....	MT5F14621

# - Fuji IGBT Module U and V Series -

$\Delta T_j$  power cycle test method and lifetime curve (technical reference material)

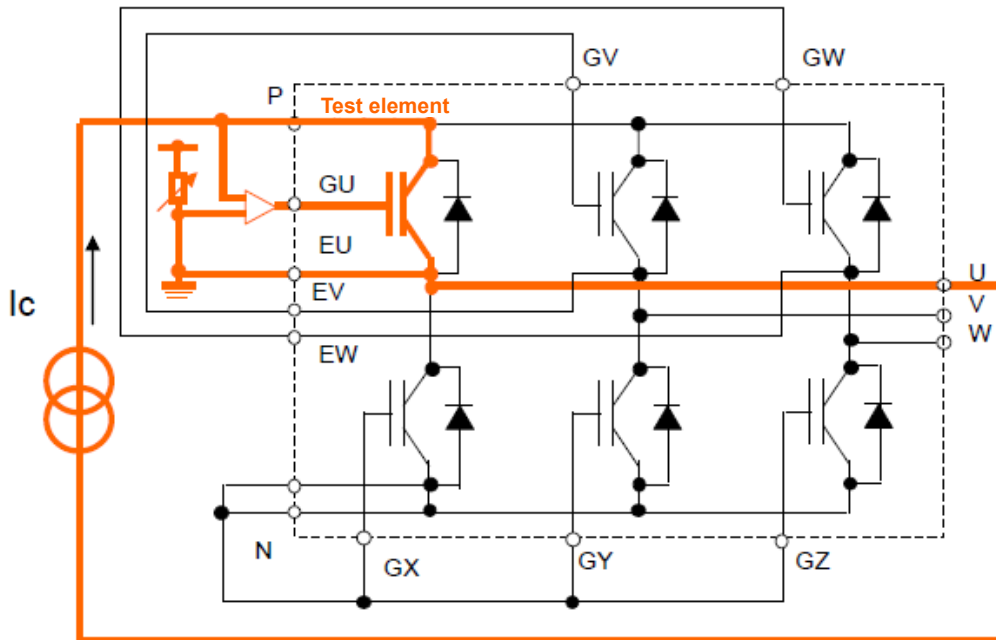

Test equivalent circuit

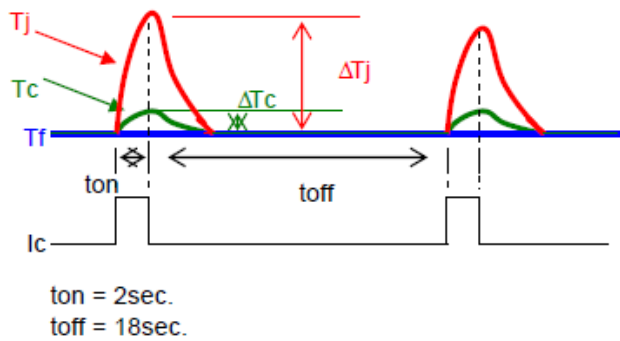

Current flow pattern of  $\Delta T_j$  power cycle and temperature change

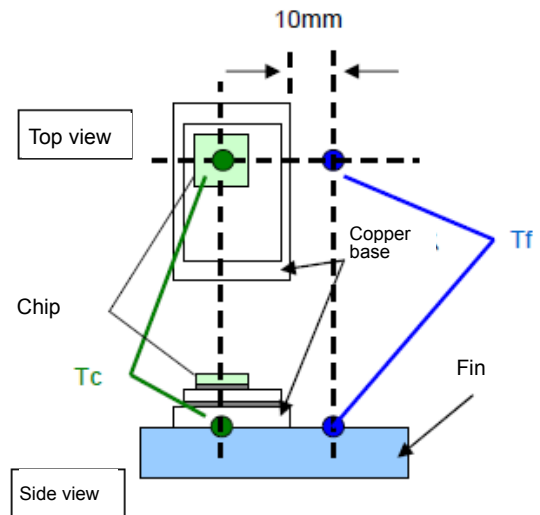

Tc and Tf measurement positions

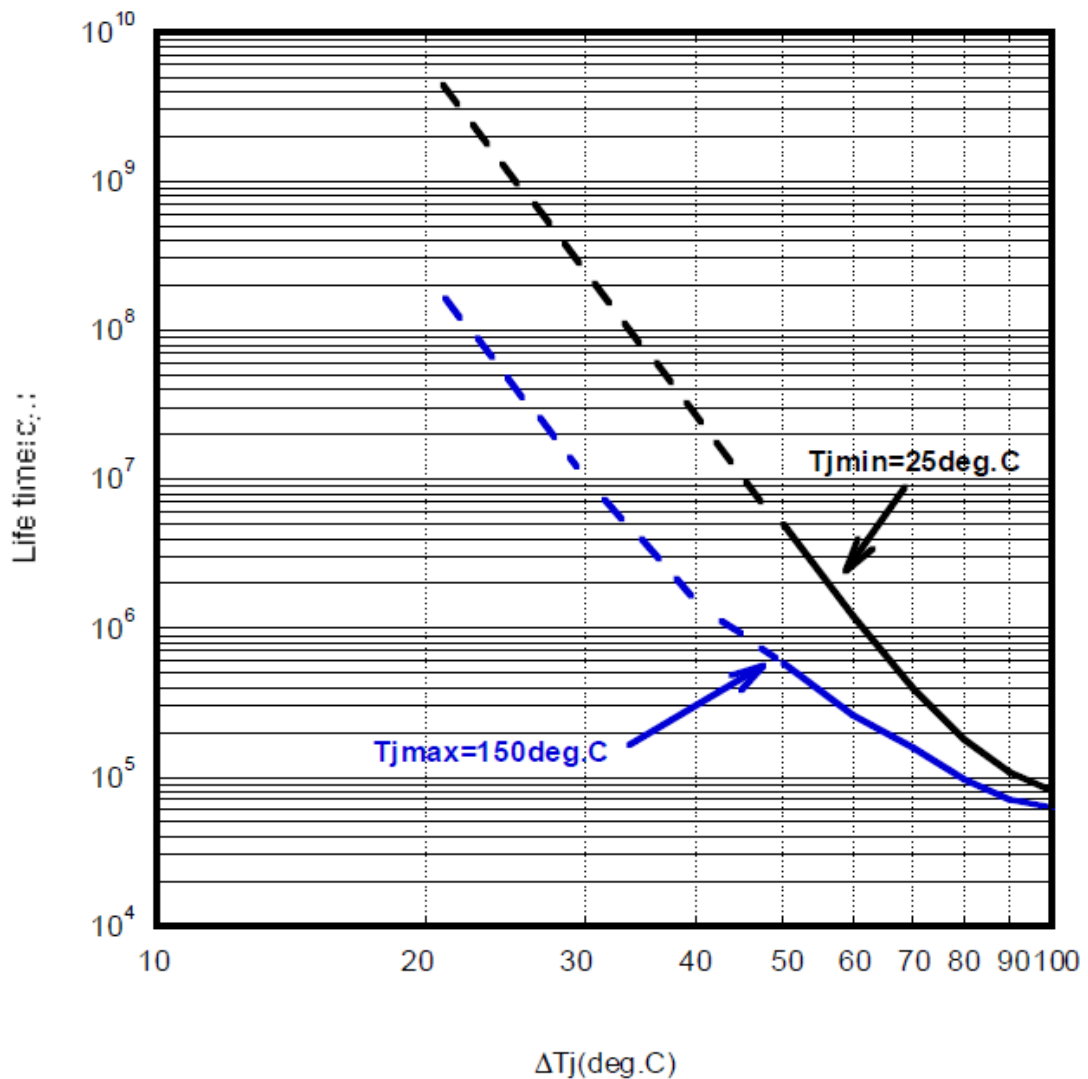

**$\Delta T_j$  Power cycling life time curve**

- \*1) The judgment criterion for failure is the point when the test element becomes open or short.
- \*2) The radiation fin and module are mounted according to our test standards.
- \*3) The capacity data in the lifetime curve is the one when the failure rate is 1% in the Weibull analysis.
- \*4) The capacity data in the lifetime curve shows the result of multiple models.
- \*5) The dotted lines show the estimated lifetime, not the guaranteed value.
- \*6) The IGBT (FWD) chips connected in parallel are not included.

# FUJI IGBT Modules U Series

## RBSOA, SCSOA 1200V

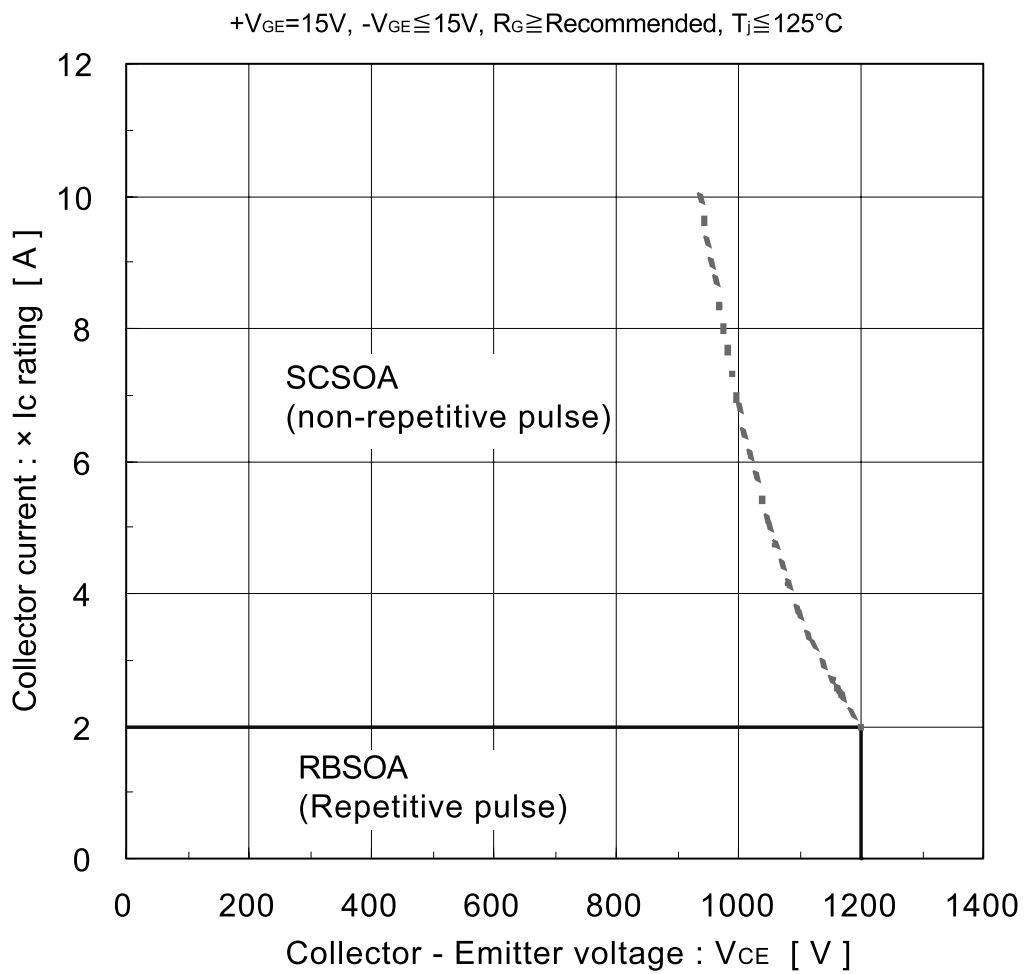

# FUJI IGBT Modules U Series

## High current output-characteristics 1200V Typical value

Conditions:  $T_j=25/125^{\circ}\text{C}$

$V_{GE}=15\text{V}$

Not include internal-drop voltage due to internal-resistance of module.

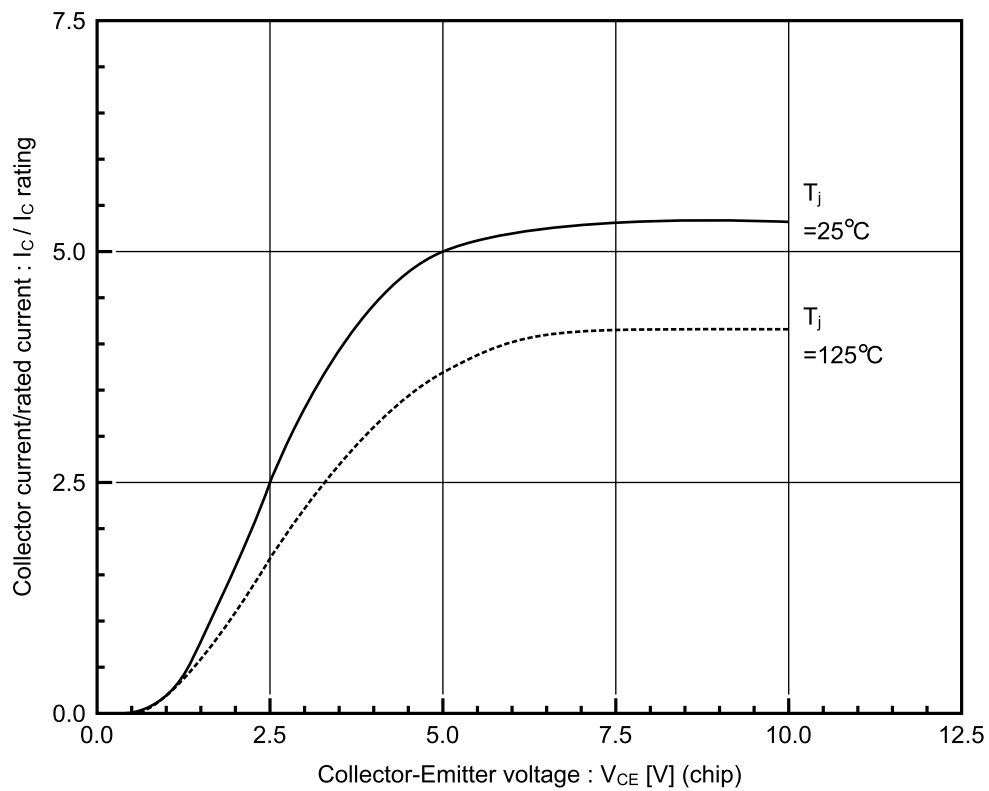

# FUJI IGBT Modules U Series

## Short circuit vs $V_{GE}$ characteristics 1200V

Sample: 2MBI150UA-120, 2MBI200UB-120, 2MBI300UD-120

Conditions:  $V_{DC}=600V$

$+V_{GE}=8, 10, 13, 15, 18V$

$-V_{GE}=15V$

$T_j=125^{\circ}C$

$R_G$  (Recommended value) = 2.2 $\Omega$  (2MBI150UA-120)

3.0 $\Omega$  (2MBI200UB-120)

1.1 $\Omega$  (2MBI300UD-120)

Results:  $V_{GE} - I_{SC}$  characteristics ..... Fig. 1

Definition of  $I_{SC}$ : Saturated current at short circuit condition

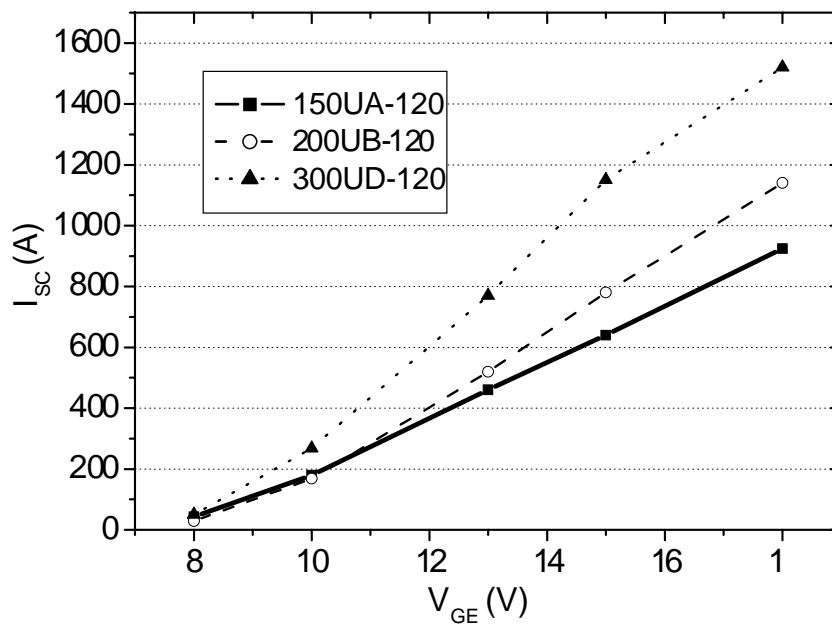
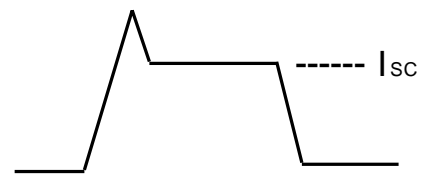

Fig. 1  $V_{GE} - I_{SC}$  characteristics

Waveforms: 2MBI150UA-120 ..... Fig. 2 to Fig. 6

2MBI200UB-120 ..... Fig. 7 to Fig. 11

2MBI300UD-120 ..... Fig. 12 to Fig. 16

2MBI150UA-120

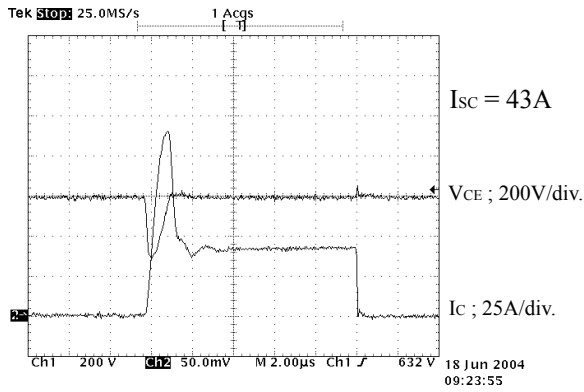

Fig. 2  $V_{GE}=8V$

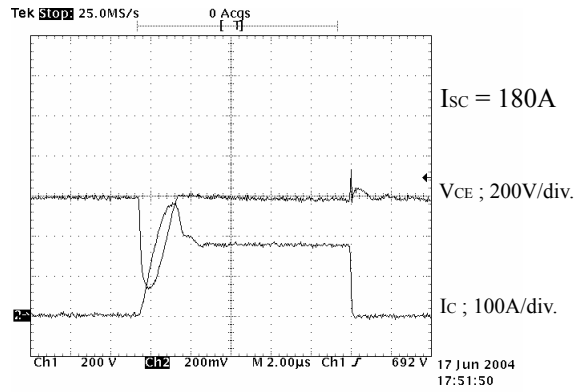

Fig. 3  $V_{GE}=10V$

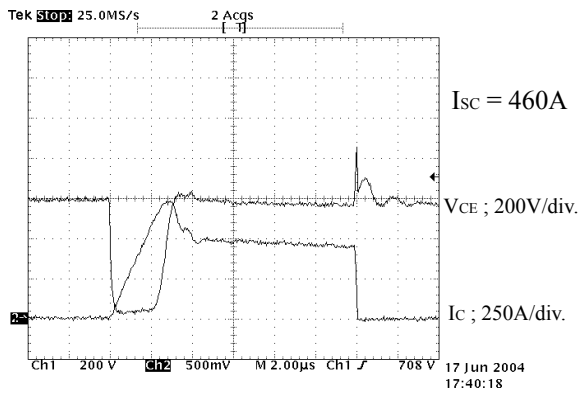

Fig. 4  $V_{GE}=13V$

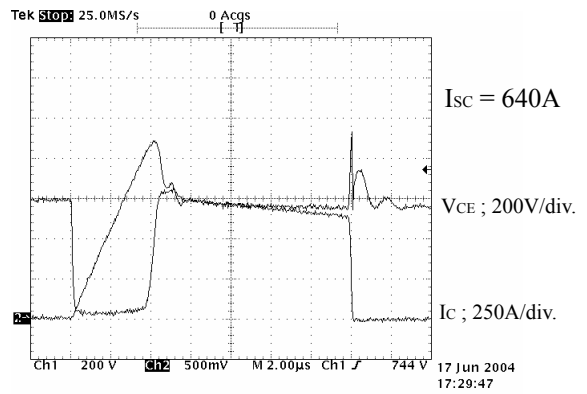

Fig. 5  $V_{GE}=15V$

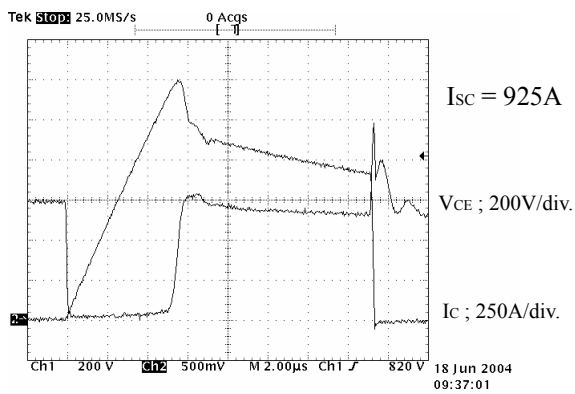

Fig. 6  $V_{GE}=18V$

2MBI200UB-120

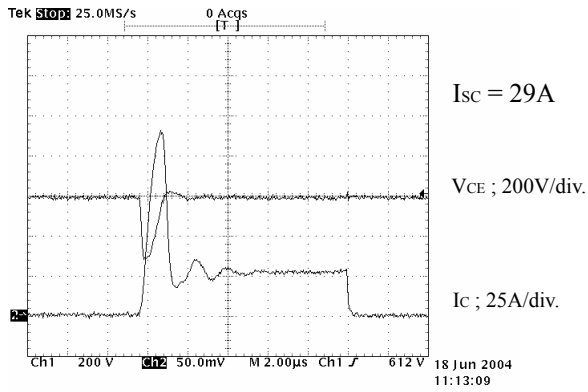

Fig. 7  $V_{GE}=8V$

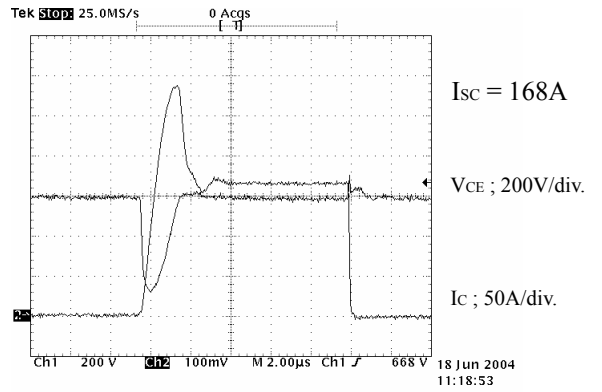

Fig. 8  $V_{GE}=10V$

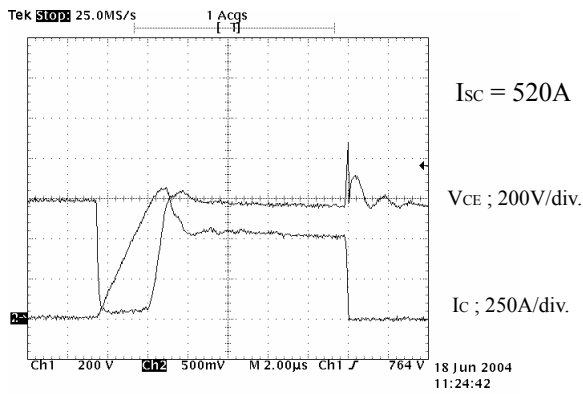

Fig. 9  $V_{GE}=13V$

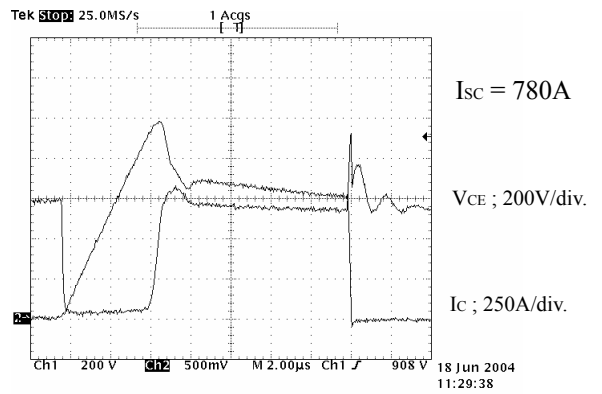

Fig. 10  $V_{GE}=15V$

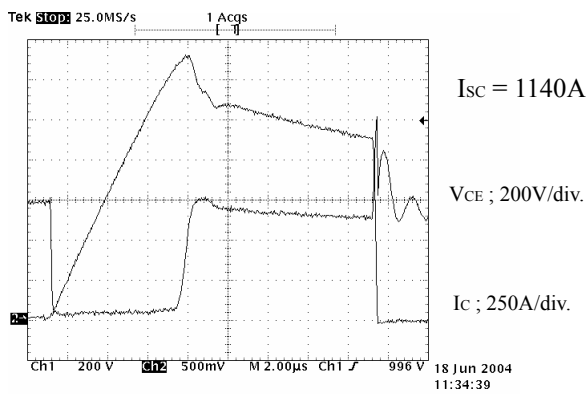

Fig. 11  $V_{GE}=18V$



2MBI300UD-120

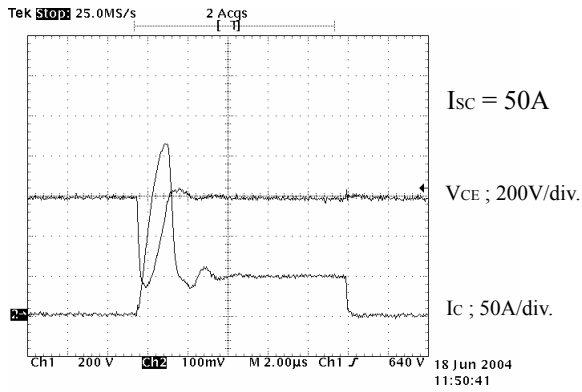

Fig. 12  $V_{GE}=8V$

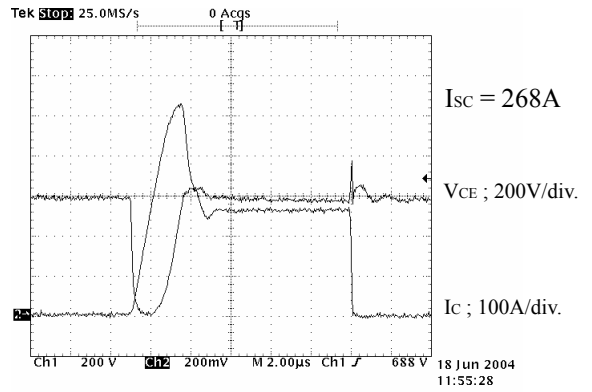

Fig. 13  $V_{GE}=10V$

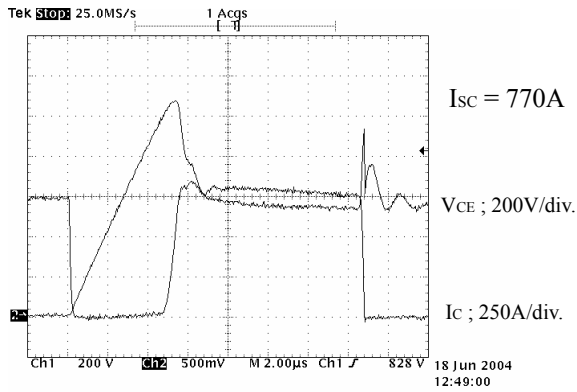

Fig. 14  $V_{GE}=13V$

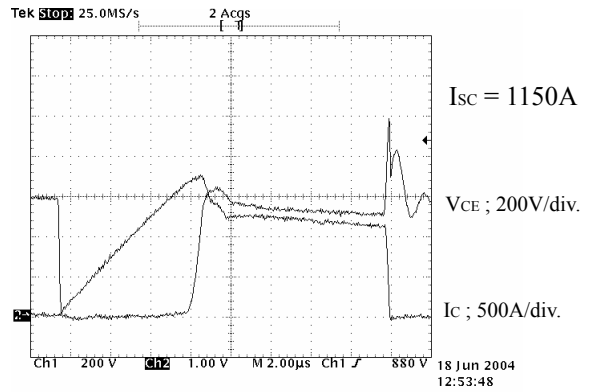

Fig. 15  $V_{GE}=15V$

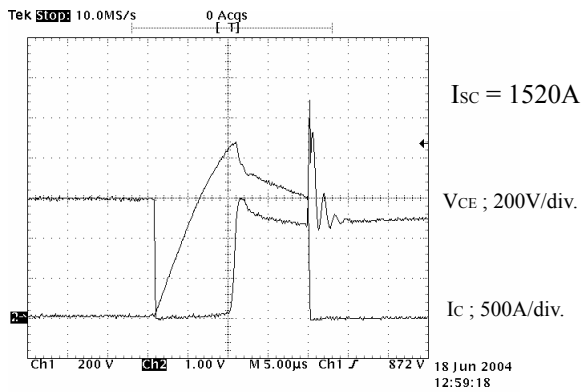
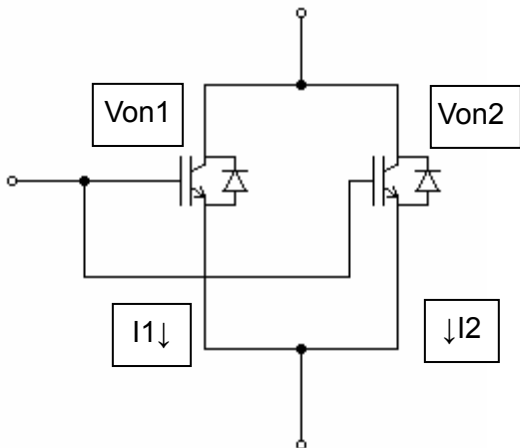

Fig. 16  $V_{GE}=18V$

## FUJI IGBT Modules U Series

### 2 in one-package module parallel connection application 1200V

#### Current imbalance in parallel connection



Configuration and equation

$$\Delta V_{on} = V_{on2} - V_{on1}$$

Current imbalance was caused by difference between  $V_{on1}$  and  $V_{on2}$ , current will be divided to  $I_1$  and  $I_2$  respectively. In this case, the current imbalance rate is defined as following equation.

$$\alpha = [I_1 / I_c(\text{ave}) - 1] \times 100(\%)$$

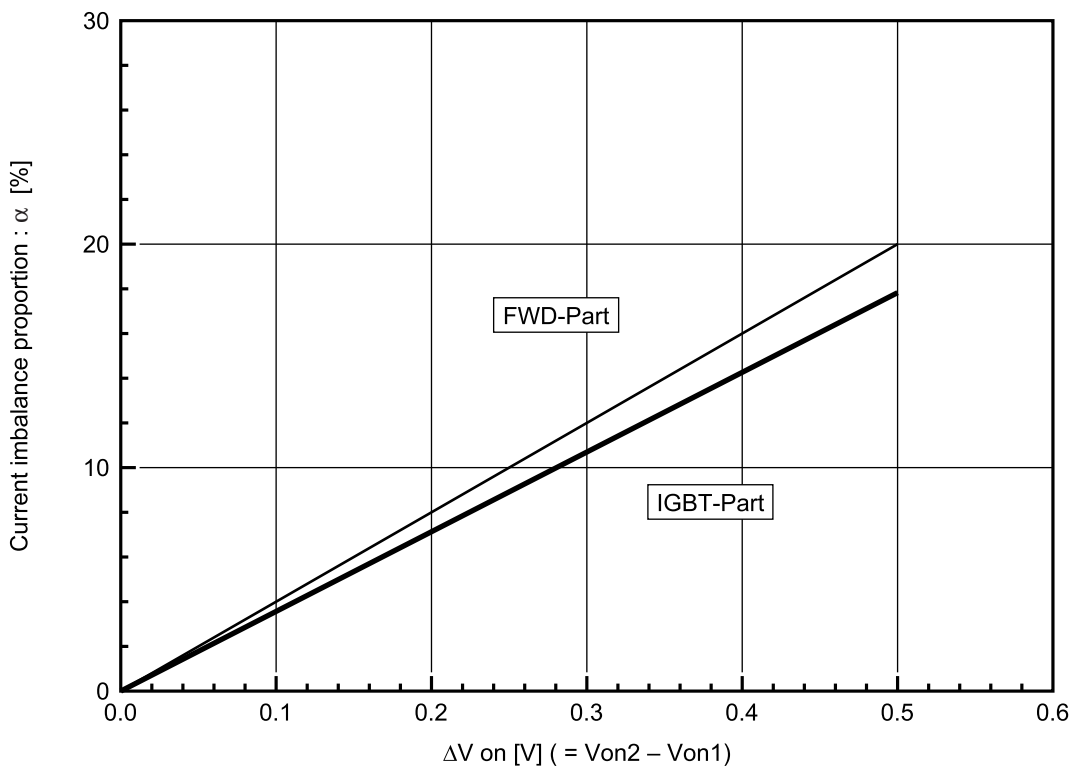

## V<sub>CE(sat)</sub>, V<sub>F</sub> distribution

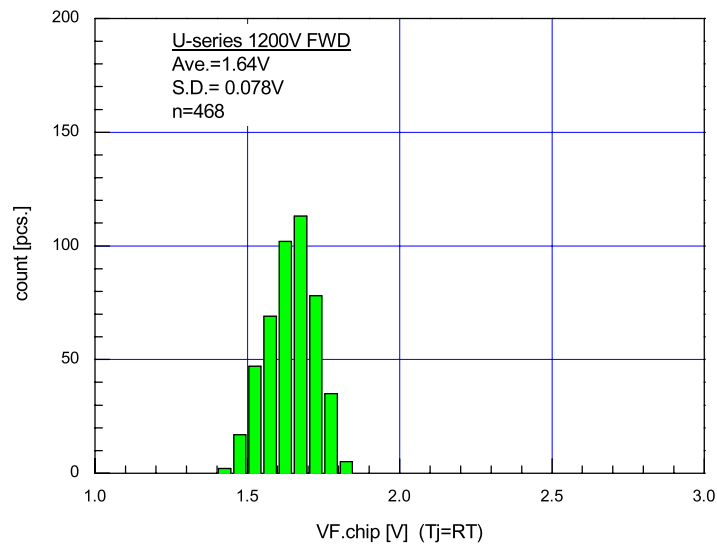
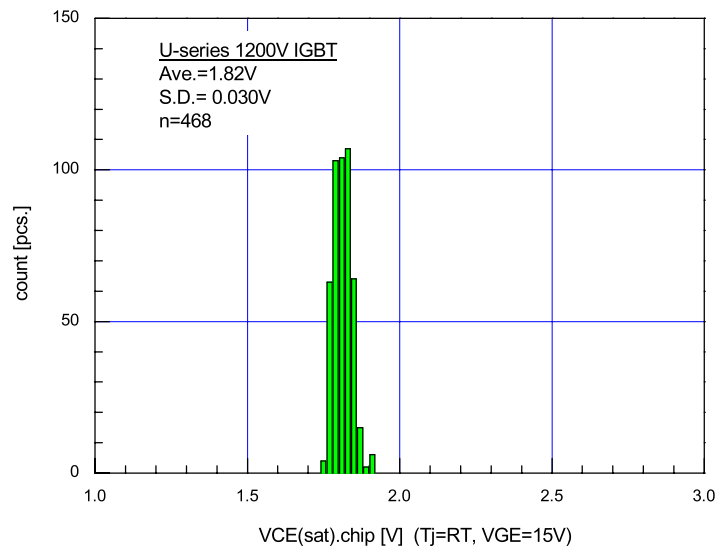

Von distribution

### Parallel connection application (Von classification)

Applicable types: 2MBI300UC-120, 2MBI300UD-120, 2MBI300UE-120, 2MBI450UE-120

Spec.	V <sub>CE(sat)</sub> rank	V <sub>F</sub> rank	Current Imbalance rate (Derating rate for parallel connection)
Standard	0.5V	0.5V	20% maximum
Selection (-03)	0.3V 1-rank	0.25 – 0.3V 4-rank	13% maximum

The standard part can be used to parallel connection application with 20% of current imbalance rate. If lower current imbalance rate is necessary, selection version (-03 at end of type number) is recommended. In this case, same rank device must be used to same arm of inverter leg.

# FUJI IGBT Modules U Series

## Switching loss, dv/dt vs $C_{GE}$ , $R_G$ 6MBI450U-120

### Reverse recovery dv/dt

Sample: 6MBI450U-120 #38001-11 Y-phase drive  
 $T_j=25^\circ\text{C}$ ,  $V_{cc}=800\text{V}$ ,  $I_c=22.5\text{A}$  (5% of rating)  
 $V_{GE}=\pm 15\text{V}$ ,  $L_s=45\text{nH}$ , Snubber C=0

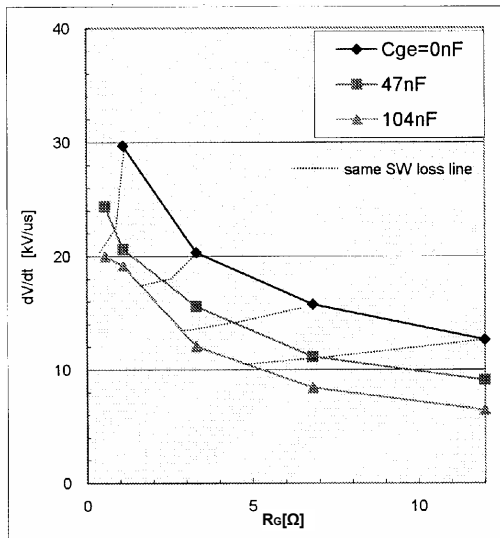

### Switching loss Eon

$T_j=125^\circ\text{C}$ ,  $V_{cc}=600\text{V}$ ,  $I_c=450\text{A}$   
 $V_{GE}=\pm 15\text{V}$ ,  $L_s=75\text{nH}$ , Snubber C=0

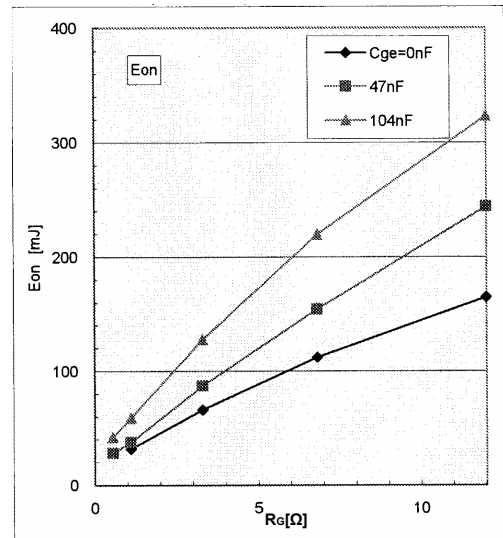

### Switching loss Eoff

$T_j=125^\circ\text{C}$ ,  $V_{cc}=600\text{V}$ ,  $I_c=450\text{A}$   
 $V_{GE}=\pm 15\text{V}$ ,  $L_s=75\text{nH}$ , Snubber C=0

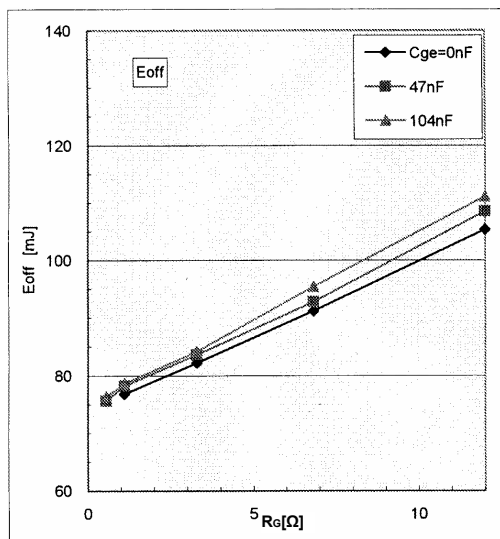

### Switching loss Err

$T_j=125^\circ\text{C}$ ,  $V_{cc}=600\text{V}$ ,  $I_c=450\text{A}$   
 $V_{GE}=\pm 15\text{V}$ ,  $L_s=75\text{nH}$ , Snubber C=0

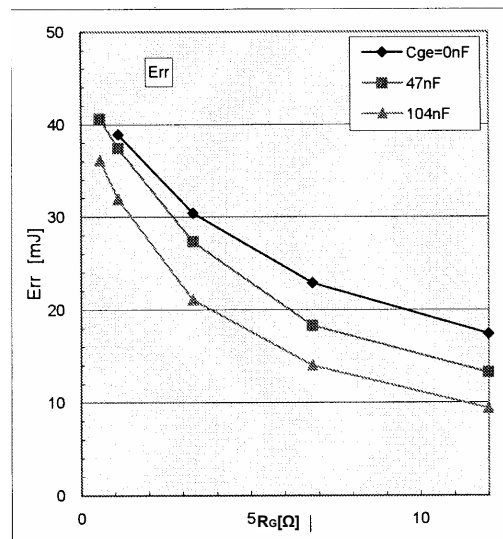

- In order to reduce dv/dt or oscillation at reverse recovery, additional  $C_{GE}$  and smaller  $R_G$  are effective.
- In order to keep same switching loss, ( $C_{GE}$  as same as  $C_{ies}$ ) +  $(0.7 \times R_G)$ , or ( $C_{GE}$  of  $2 \times C_{ies}$ ) +  $(0.5 \times R_G)$  are recommended. These are same manner also for other 1200V U-series IGBT module.

### Reverse recovery dv/dt

Sample: 6MBI450U-120 #38001-11 Y-phase drive

Tj=25°C, Vcc=800V, Ic=22.5A, VGE=±15V, Ls=45nH, Snubber C=0

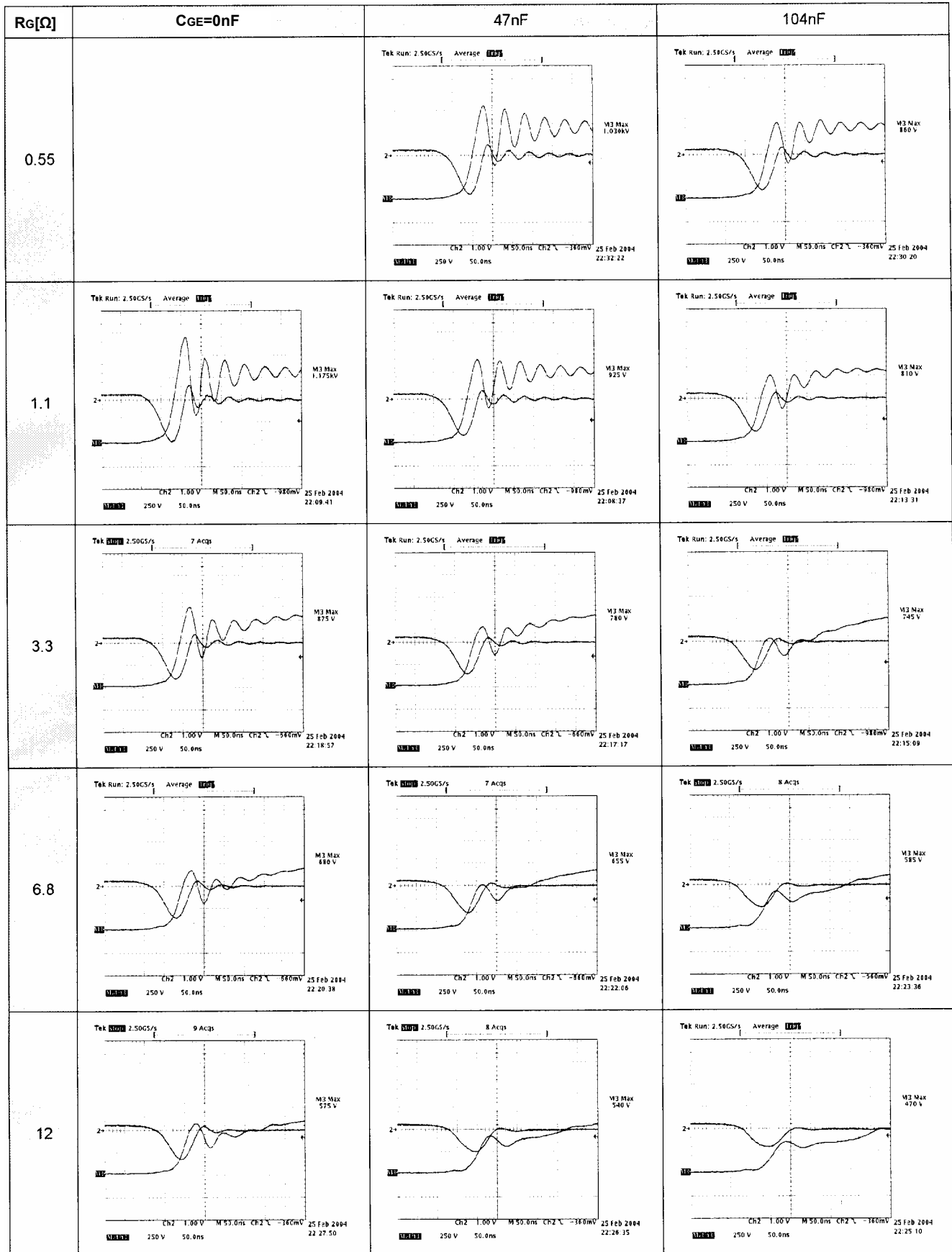

# Eon (Latest sample)

Sample: 6MBI450U-120 #38001-11 Y-phase drive

Tj=125°C, Vcc=600V, Ic=450A, VGE=±15V, Ls=75nH, Snubber C=0

Rg[Ω]	Cge=0nF	47nF	104nF
0.55			
1.1			
3.3			
6.8			
12			

# Eoff (Latest sample)

Sample: 6MBI450U-120 #38001-11 Y-phase drive

Tj=125°C, Vcc=600V, Ic=450A, VGE=±15V, Ls=75nH, Snubber C=0

Rg[Ω]	CGE=0nF	47nF	104nF
0.55			
1.1			
3.3			
6.8			
12			

### Err (Latest sample)

Sample: 6MBI450U-120 #38001-11 Y-phase drive

Tj=125°C, Vcc=600V, Ic=450A, VGE=±15V, Ls=75nH, Snubber C=0

Rg[Ω]	Cge=0nF	47nF	104nF
0.55			
1.1			
3.3			
6.8			
12			



## FUJI IGBT Modules U Series

### -V<sub>GE</sub> vs switching loss characteristics 6MBI150UB-120

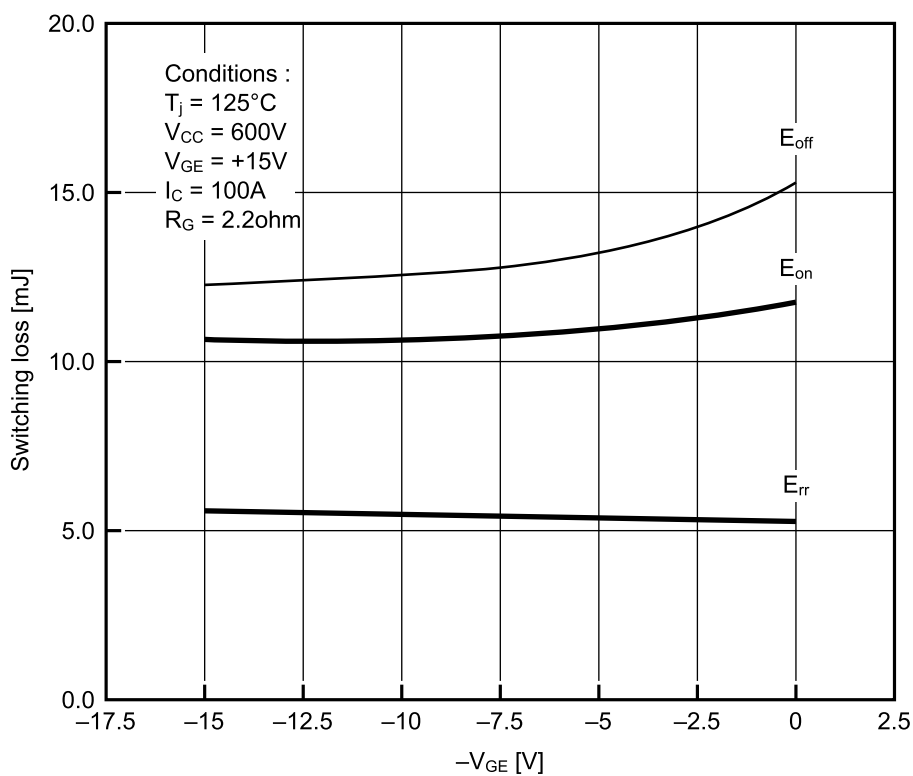

# FUJI IGBT Modules U Series

## Dependence of blocking voltage and junction temp. 1700V

For 1700V-U series (Engineering samples), such as 6MBI450U-170 and others.

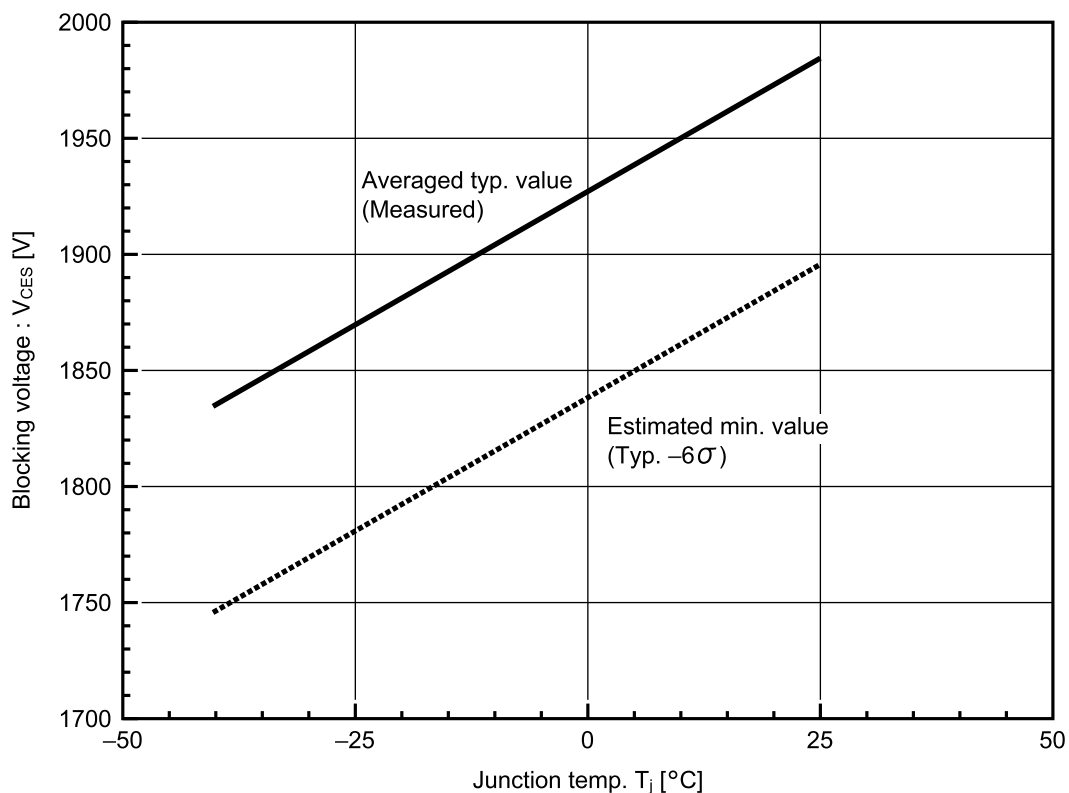

# FUJI IGBT Modules U Series

## $V_{CES}$ vs $T_j$ characteristics 1200V

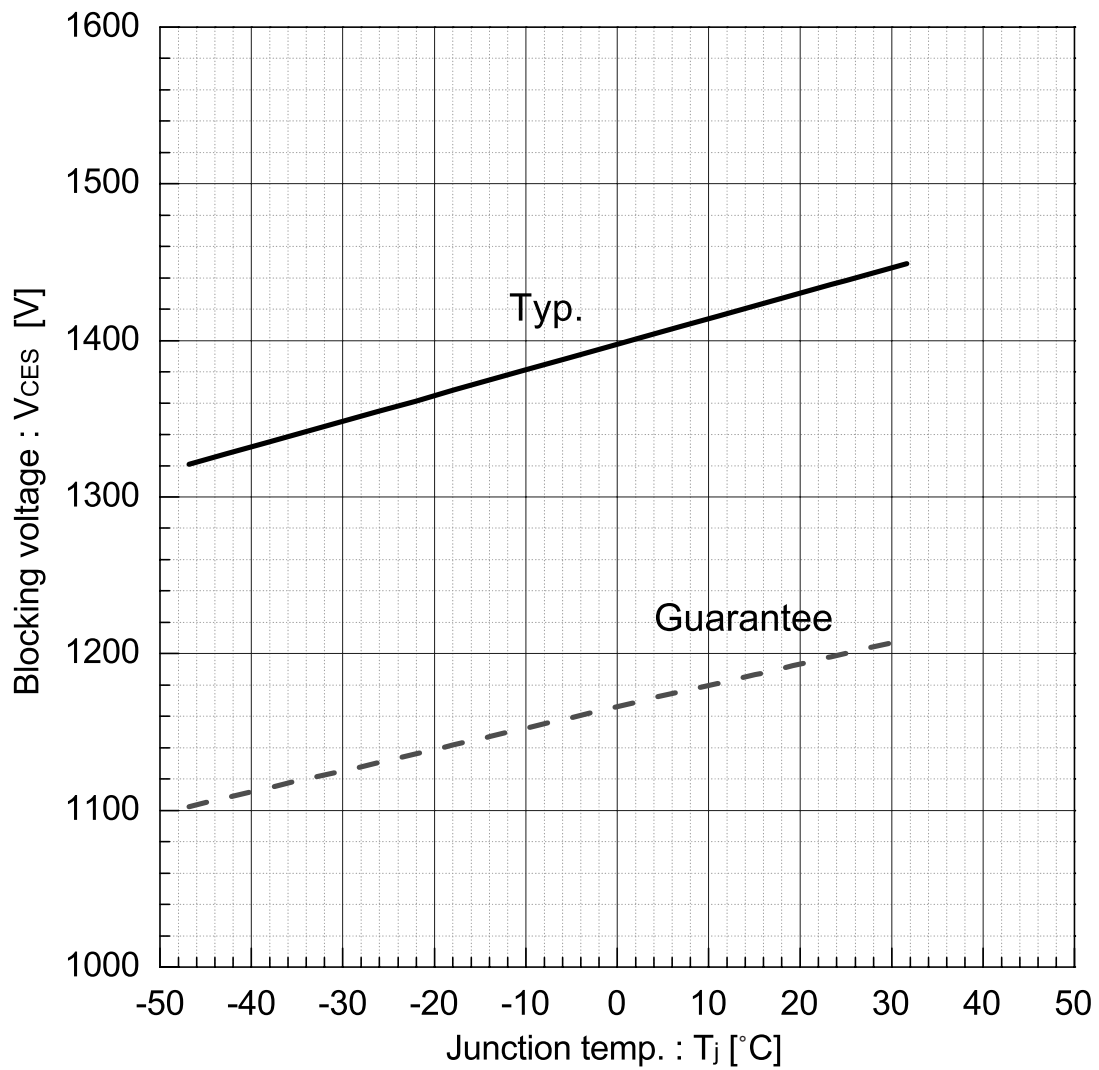

## FUJI IGBT Modules U Series

### -di/dt vs T<sub>j</sub> characteristics 1200V, 6MBI450U-120

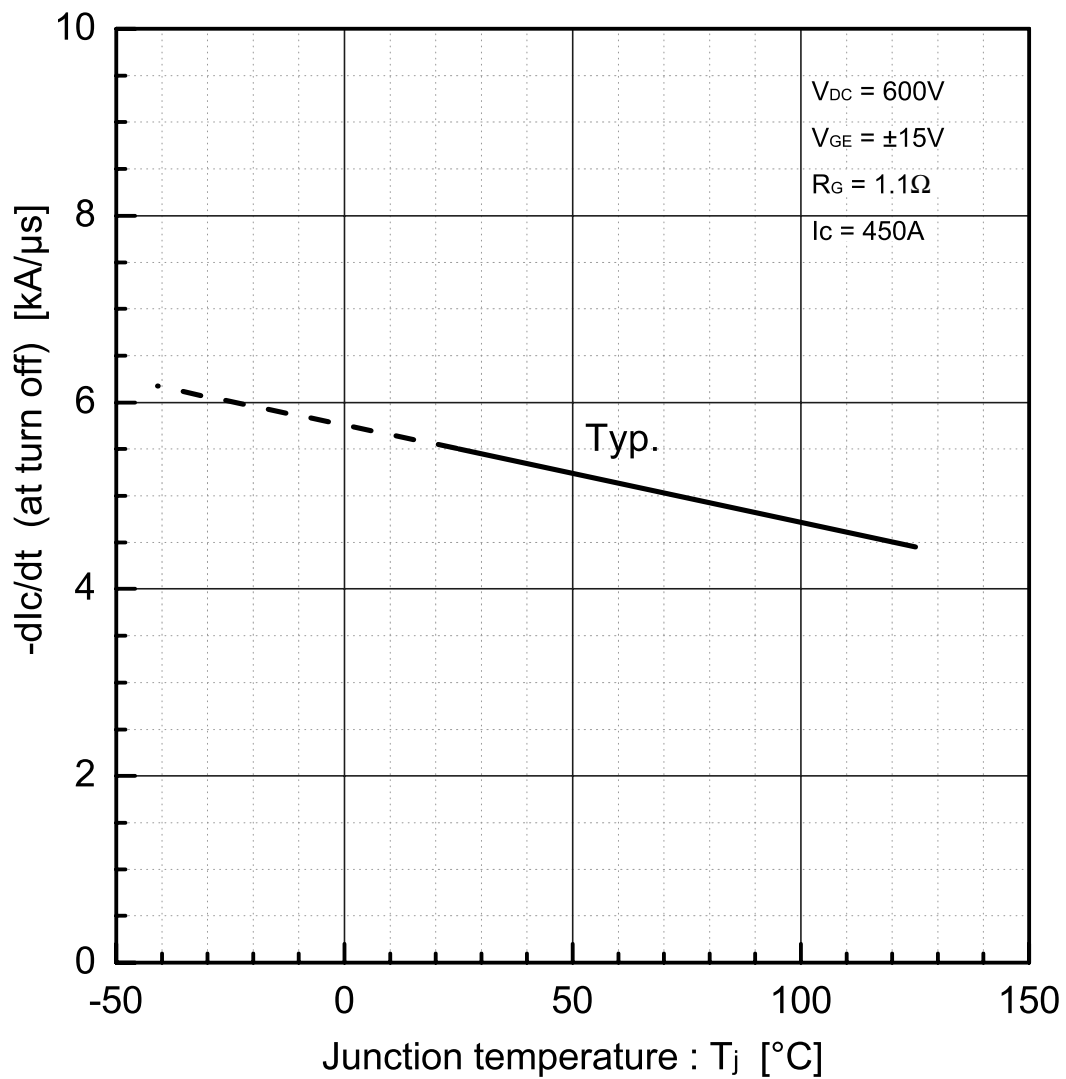

## FUJI IGBT Modules U Series

### Dynamic avalanche voltage vs $T_j$ characteristics

1200V 6MBI450U-120

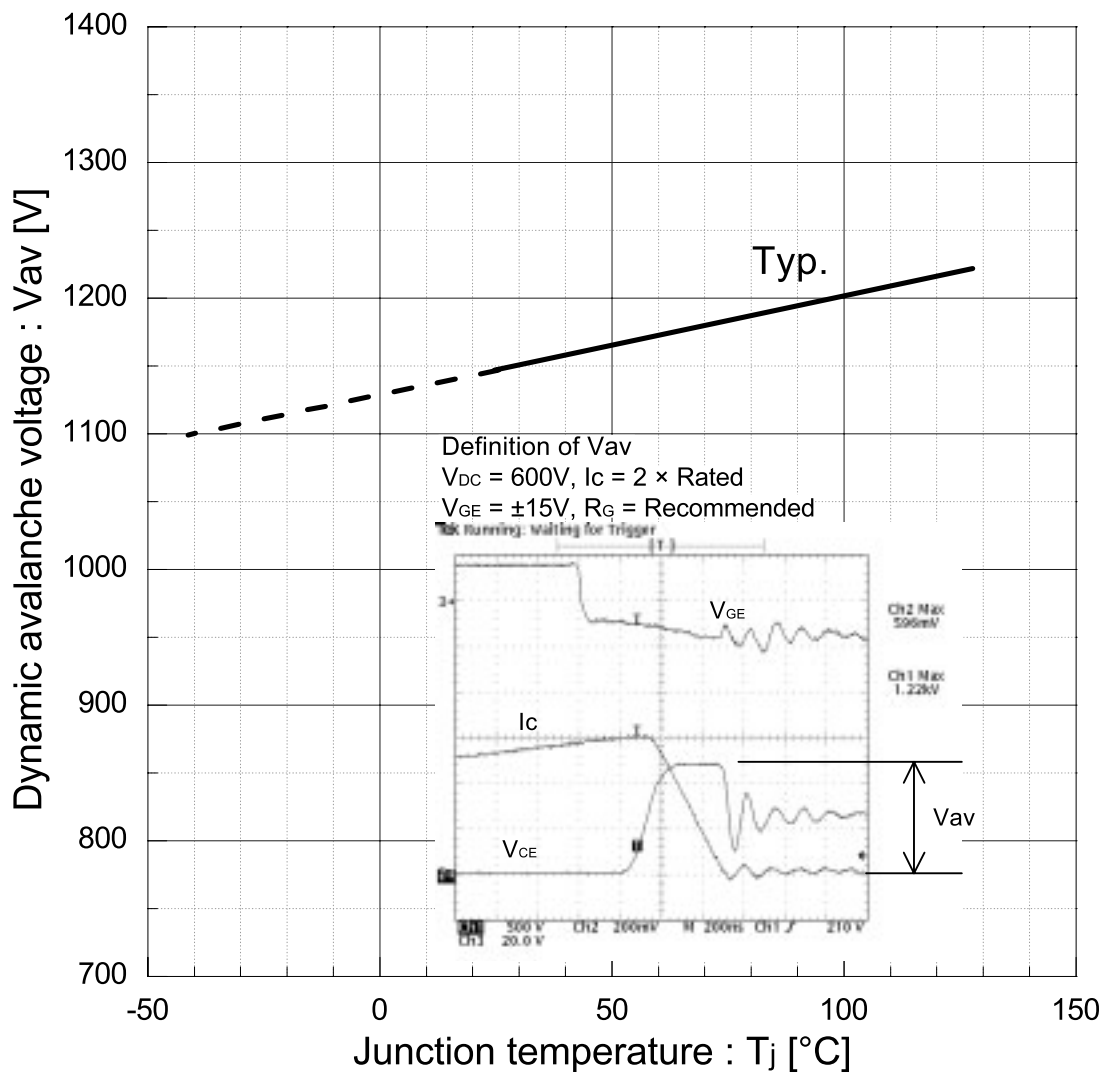

# FUJI IGBT Modules U Series

## Transient thermal impedance Calculated value

### Definition of case temperature position

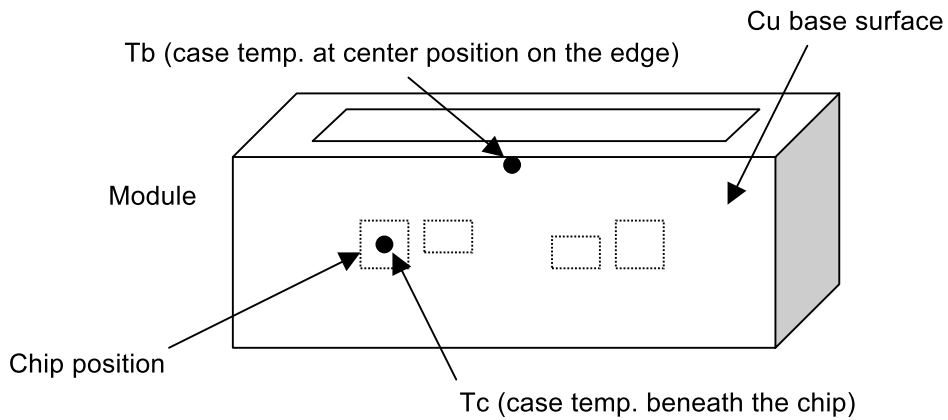

### 2MBI150UA-120 Rth(j-c)

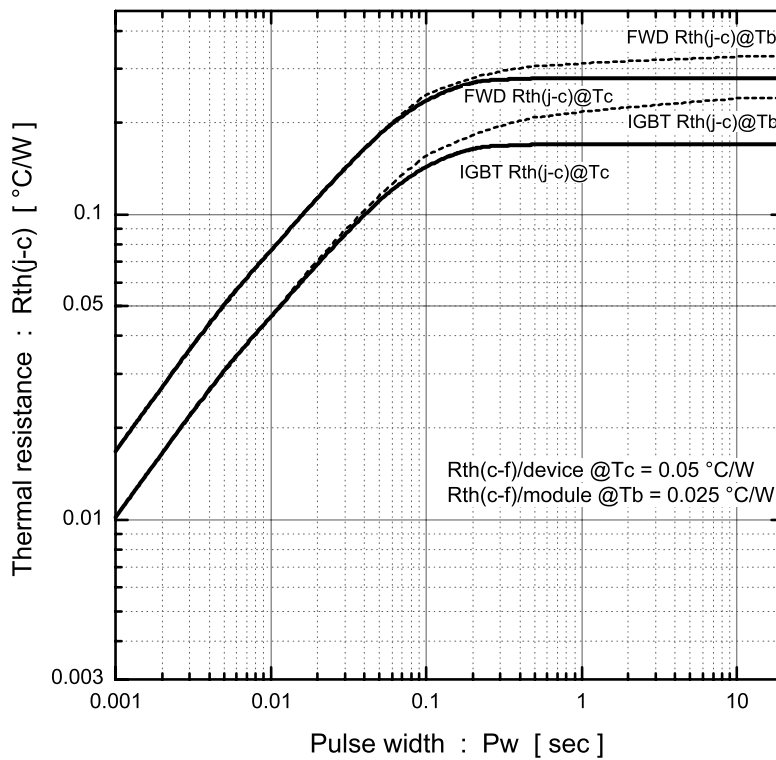

**2MBI150UB-120 Rth(j-c)**

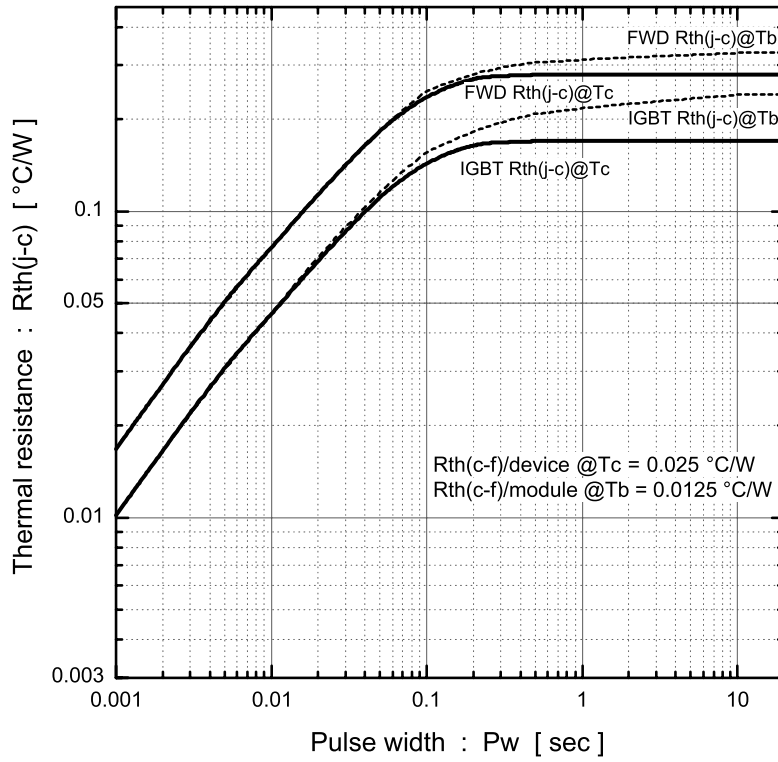

**2MBI200UB-120 Rth(j-c)**

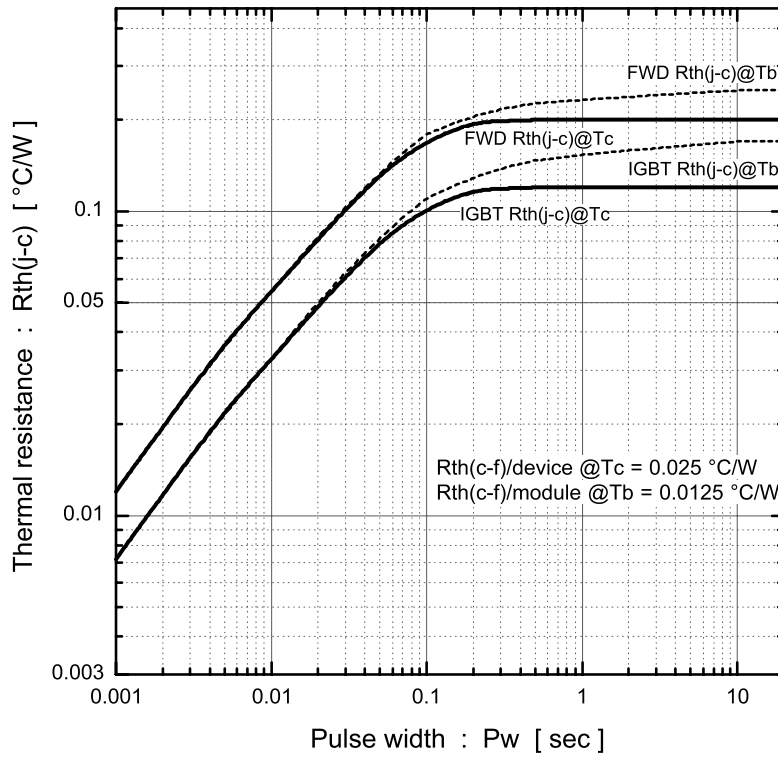

**2MBI300UC-120 Rth(j-c)**

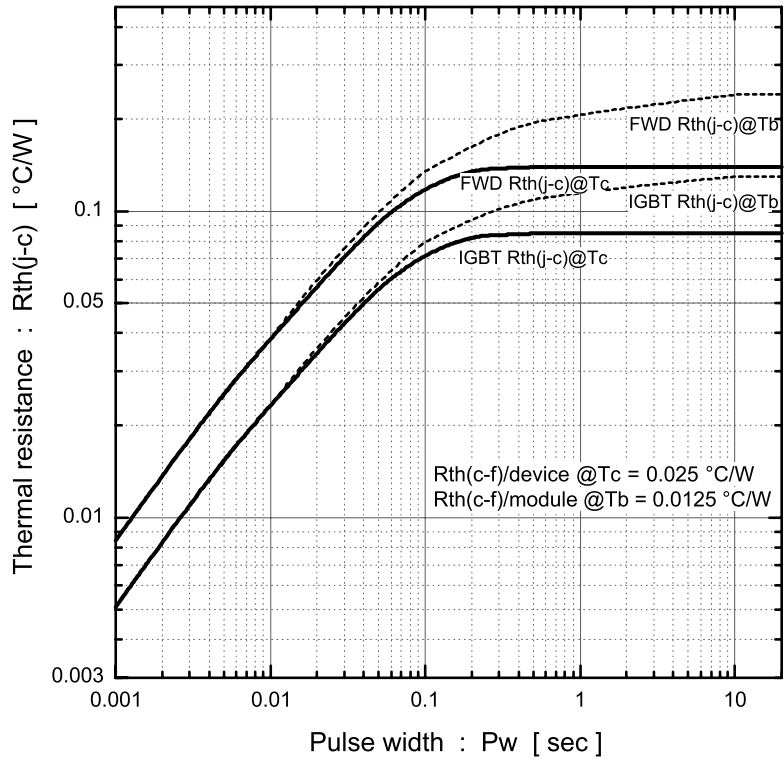

**2MBI450UE-120 Rth(j-c)**

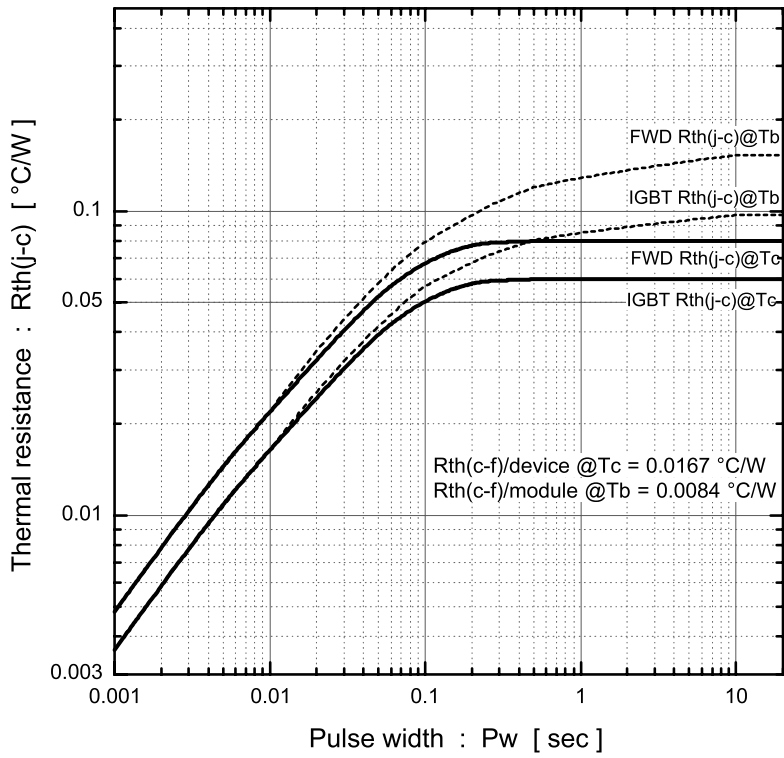



**2MBI300U2B-060 Rth(j-c)**

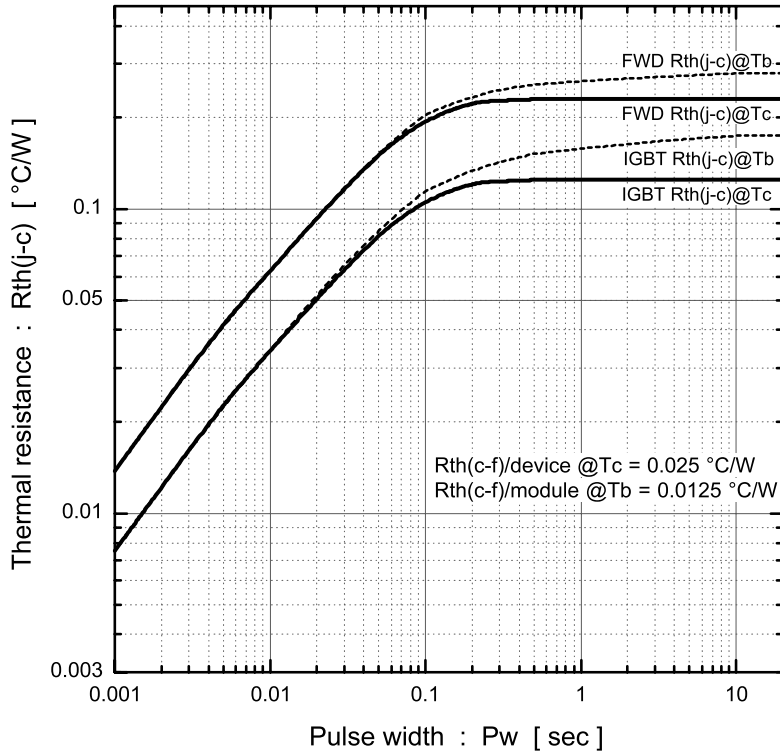

**2MBI400U2B-060 Rth(j-c)**

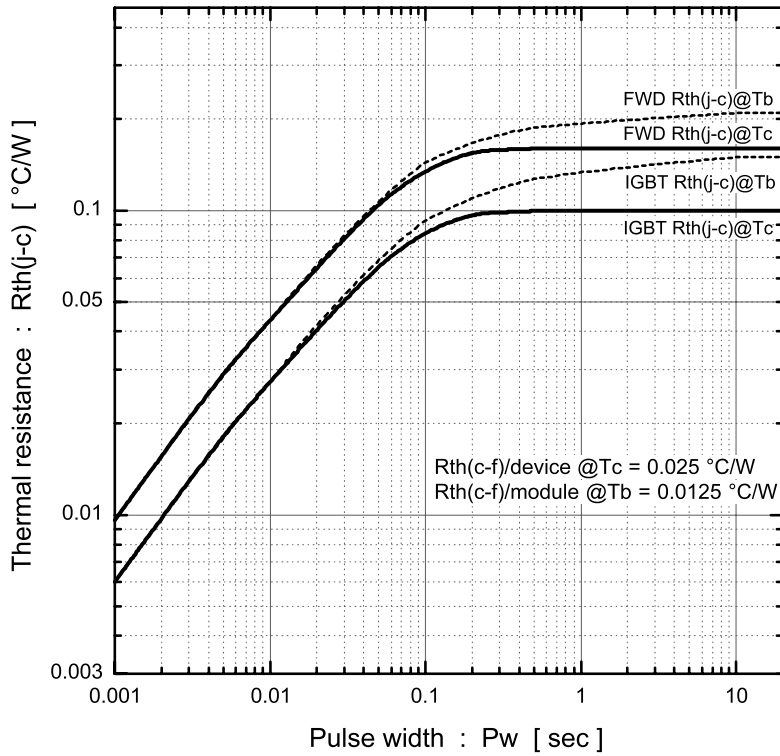

**6MBI225U-120 Rth(j-c)**

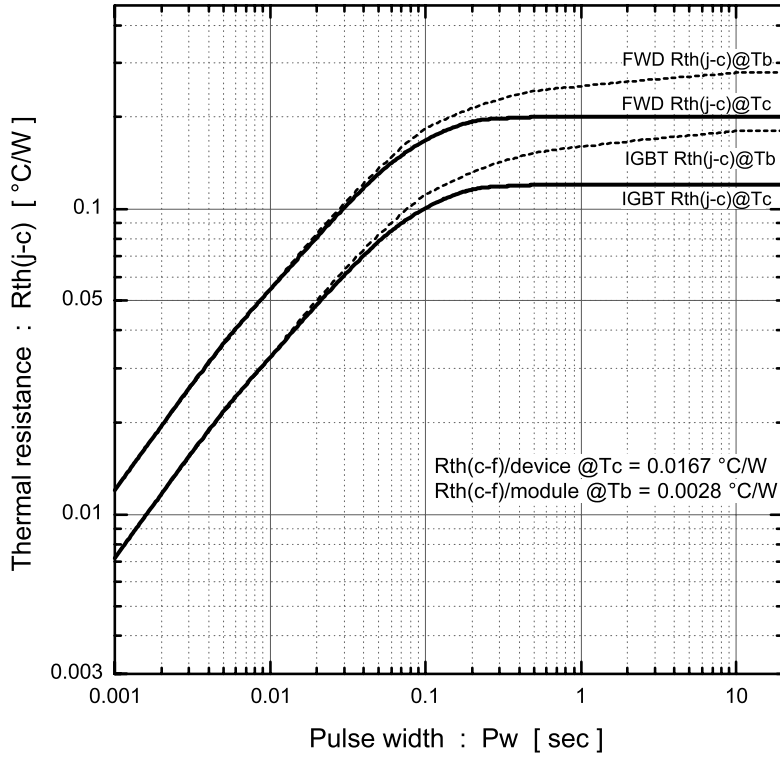

**6MBI300U-120 Rth(j-c)**

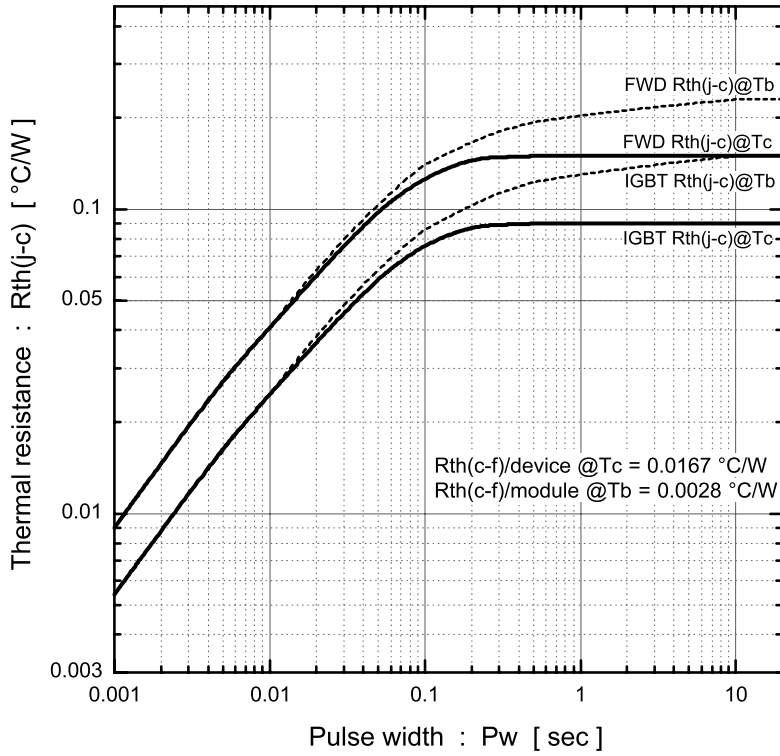

6MBI450U-120 Rth(j-c)

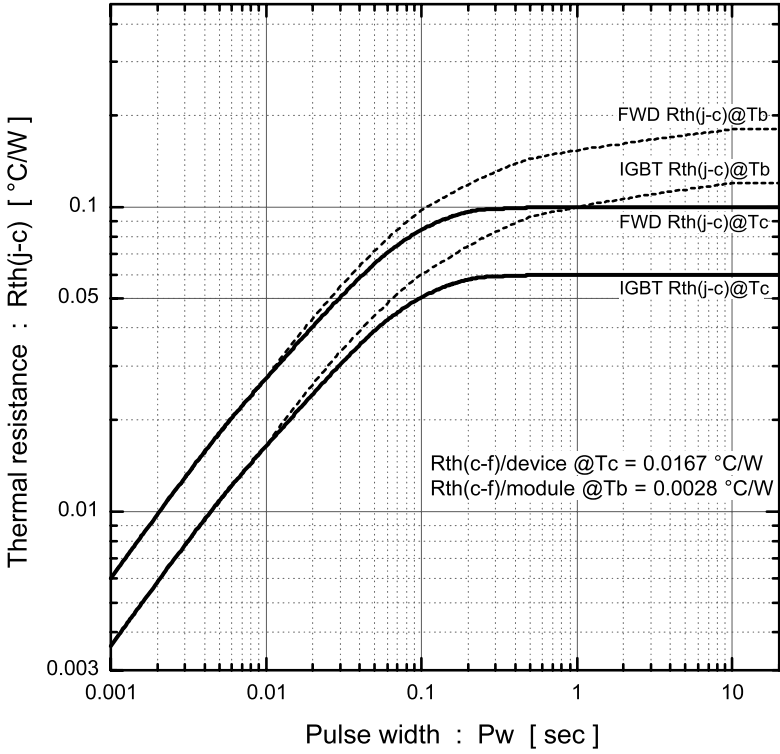

## WARNING

1. This Catalog contains the product specifications, characteristics, data, materials, and structures as of May 2011.  
The contents are subject to change without notice for specification changes or other reasons. When using a product listed in this Catalog, be sure to obtain the latest specifications.
2. All applications described in this Catalog exemplify the use of Fuji's products for your reference only. No right or license, either express or implied, under any patent, copyright, trade secret or other intellectual property right owned by Fuji Electric Co., Ltd. is (or shall be deemed) granted. Fuji Electric Co., Ltd. makes no representation or warranty, whether express or implied, relating to the infringement or alleged infringement of other's intellectual property rights which may arise from the use of the applications described herein.
3. Although Fuji Electric Co., Ltd. is enhancing product quality and reliability, a small percentage of semiconductor products may become faulty. When using Fuji Electric semiconductor products in your equipment, you are requested to take adequate safety measures to prevent the equipment from causing a physical injury, fire, or other problem if any of the products become faulty. It is recommended to make your design failsafe, flame retardant, and free of malfunction.
4. The products introduced in this Catalog are intended for use in the following electronic and electrical equipment which has normal reliability requirements.
  - Computers
  - OA equipment
  - Communications equipment (terminal devices)
  - Measurement equipment
  - Machine tools
  - Audiovisual equipment
  - Electrical home appliances
  - Personal equipment
  - Industrial robots etc.
5. If you need to use a product in this Catalog for equipment requiring higher reliability than normal, such as for the equipment listed below, it is imperative to contact Fuji Electric Co., Ltd. to obtain prior approval. When using these products for such equipment, take adequate measures such as a backup system to prevent the equipment from malfunctioning even if a Fuji's product incorporated in the equipment becomes faulty.
  - Transportation equipment (mounted on cars and ships)
  - Trunk communications equipment
  - Traffic-signal control equipment
  - Gas leakage detectors with an auto-shut-off feature
  - Emergency equipment for responding to disasters and anti-burglary devices
  - Safety devices
  - Medical equipment
6. Do not use products in this Catalog for the equipment requiring strict reliability such as the following and equivalents to strategic equipment (without limitation).
  - Space equipment
  - Aeronautic equipment
  - Nuclear control equipment
  - Submarine repeater equipment
7. Copyright ©1996-2011 by Fuji Electric Co., Ltd. All rights reserved.  
No part of this Catalog may be reproduced in any form or by any means without the express permission of Fuji Electric Co., Ltd.
8. If you have any question about any portion in this Catalog, ask Fuji Electric Co., Ltd. or its sales agents before using the product. Neither Fuji Electric Co., Ltd. nor its agents shall be liable for any injury caused by any use of the products not in accordance with instructions set forth herein.