

---

---

# – Chapter 5 –

## Cooling Design

---

---

Table of Contents		Page
1	Method for selection of heat sink .....	5-2
2	Important remarks for selection of a heat sink .....	5-2
3	How to mount the IPM .....	5-3

## 1 Guidelines for heat sink selection

- To safely operate the IGBT, it is necessary that the junction temperature  $T_j$  should not exceed  $T_{jmax}$ . Carry out thermal design having sufficient margins so that the junction temperature  $T_j$  never exceeds the  $T_{jmax}$  also on occurrence of disorder such as overload.
- There is a risk of thermal breakdown, if the IGBT is operated at temperature above the  $T_{jmax}$ . Although the  $T_{jOH}$  protected function in the IPM activates when the junction temperature exceeds the  $T_{jmax}$ , however, there is a possibility that the protection cannot work if the temperature rises rapidly. Also pay attention to the FWD so that the  $T_{jmax}$  should not be exceeded, same case for the IGBT.
- The heat sink temperature should be measured just below the center of the chip. Please refer to the IPM specification sheet for the chip layout drawing. In addition, please consider the following documents regarding to the design for your reference.

[IGBT Module Application Manual RH984b]

- How to calculate the occurred loss
- How to select a heat sink
- How to mount IPM to a heat sink
- Troubleshooting

## 2 Notice for heat sink selection

Although a guideline for heat sink selection is described in the IGBT Module Application Manual (RH984b), please pay attention to the following recommendations as well.

### 2.1 Flatness of the heat sink surface

It is recommended that flatness of the heat sink surface is less than  $50 \mu\text{m}$  per 100 mm between screw mounting points and the surface roughness is less than  $10 \mu\text{m}$ .

If the heat sink surface is concave or convex, the contact thermal resistance ( $R_{th(c-f)}$ ) will be increased.

[Reason]

- Concave: A gap appears between the heat sink surface and the bottom of the IPM, and the heat transfer performance becomes worse (contact thermal resistance  $R_{th(c-f)}$  increases).
- Convex (larger than  $+50 \mu\text{m}$ ): The copper base of the IPM is deformed and there is a possibility of a generation of cracks on the internal insulated board by the mechanical stress.

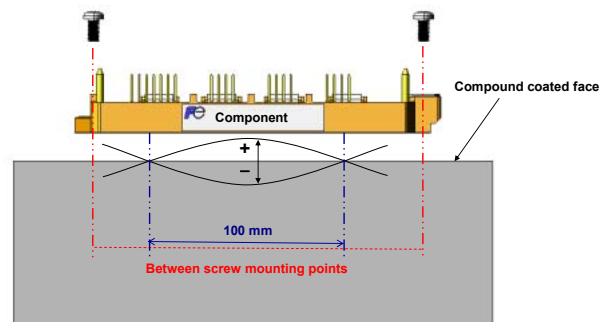

Figure 5-1 Flatness of heat sink surface

### 3 Mounting instruction of the IPM

#### 3.1 Layout of IPMs on a heat sink

The thermal resistance varies depending on the IPM mounting position. Please note the following matters:

- When an IPM is mounted to a heat sink, it is recommended to place the IPM on the center of the heat sink to maximize the usage of the heat sink.
- When multiple IPMs are mounted to a single heat sink, the IPMs location and layout should be designed with their generated losses. Allocate the largest area to the IPM which generates largest loss.

#### 3.2 Application of thermal grease

To reduce the contact thermal resistance, apply thermal grease between the IPM and heat sink mounting surface.

Use of a stencil mask and use of a roller are available in general as methods for application of thermal grease.

The purpose of the thermal grease is to promote heat transmission to the heat sink, but the grease has a limited thermal capacity. If the thickness of thermal grease is larger than the appropriate thickness, the grease layer prevents the heat transfer from the IPM to the heat sink and the junction temperature will be increased. On the other hand, if the thermal grease thickness is less than the appropriate thickness, such as a void area, a gap or space may be caused between the heat sink and the IPM. This may cause an increase of the contact thermal resistance. Therefore thermal grease should be applied in appropriate thickness.

If the thermal grease thickness is inadequate, the thermal dissipation of heat becomes worse, and there is a possibility of breakdown in the worst case due to the excess of the junction temperature  $T_{jmax}$ .

Application of thermal grease using a stencil mask is recommended so that uniform thickness can be achieved.

Figure 5-2 shows an example of a thermal grease application using a stencil mask. The basis of this method is applying specified weight of thermal grease to the metallic base of the IPM using a stencil mask. It is possible to achieve a uniform thickness of thermal grease by mounting the IPM with thermal grease to the heat sink and tightening screws with recommended torque for each product. Fuji Electric can provide recommended stencil mask designs upon request of customers.



1. Back to Room Temp.



2. Measure weight of IGBT



3. Adjust zero



4. Bottom tool



5. Set IGBT module

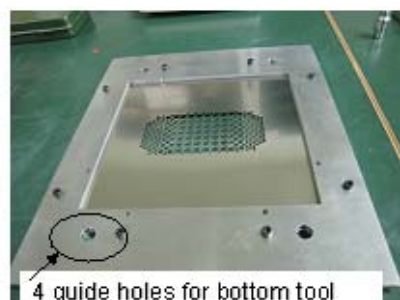

6. Metal mask and Frame

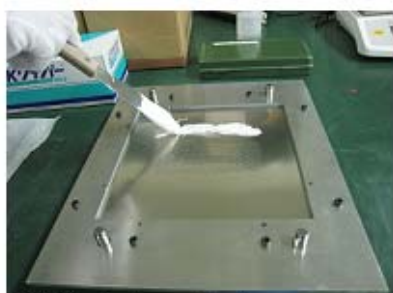

7. Fix tools and put grease with Knife

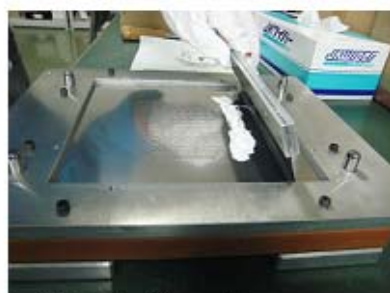

8. Print with metal squeegee (begin)



9. Print with metal squeegee (end)

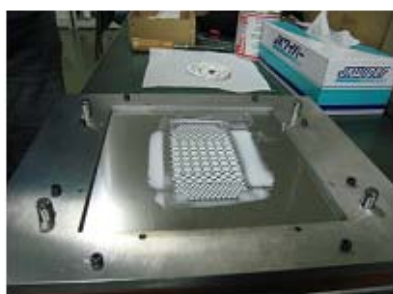

10. After printing



11. Open metal mask



12. Check grease weight

Figure 5-2 Outline of a thermal grease application method

The required thermal grease weight is given by the following equation by assuming uniform thermal grease thickness:

$$\text{Thermal grease weight (g) } \times 10^{-4} = \frac{\text{Thermal grease thickness } (\mu\text{m}) \times \text{IPM base area (cm}^2\text{)}}{\text{Thermal grease density (g/cm}^3\text{)}}$$

Calculate the thermal grease weight that corresponds to the required thermal grease thickness from this equation, and apply the thermal grease. The recommended thermal grease thickness after spreading of thermal grease is 100  $\mu\text{m}$ . Also please note that the optimum thermal grease thickness varies by the characteristics of the used thermal grease and application method.

Table 5-1 shows the footprint area of IPMs.

Table 5-1 Back Base plate area of IPM

Package	Back side base area (cm <sup>2</sup> )
P629	21.71
P626	22.77
P630	55.67
P631	141.24
P636	41.17

Table 5-2 Shows recommended thermal greases (typical)

Table 5-2 Typical thermal greases

Type	Manufacturer
G746	Shin-Etsu Chemical Co., Ltd.
TG221	Nippon Data Material Co., Ltd.
SC102	Dow Corning Toray Co., Ltd.
YG6260	Momentive Performance Materials Inc.
P12	Wacker Chemie
HTC	ELECTROLUBE

The list of thermal greases shown above is based on the information at the time of issuance of this Application Manual. Please contact these manufacturers for details of these thermal greases.

### 3.4 Screw tightening

Figure 5-3 shows screw-tightening procedures for mounting an IPM to a heat sink. It is recommended to tighten all screws with specified tightening torque.

The specified tightening torque is described in the specification. If the screw tightening torque is insufficient, there is a possibility of increasing the contact thermal resistance or losing screws during operation. If the tightening torque is excessive, on the other hand, the case would be damaged.

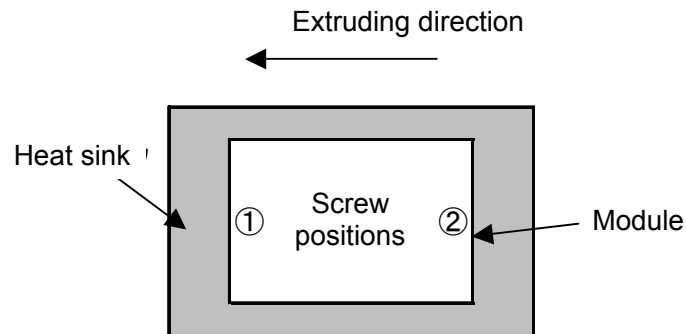

	Torque	Order
1st time (initial tightening)	1/3 of specified torque	(1) (2)
2nd time (permanent tightening)	100% of specified torque	(2) (1)

(1) Case of IPM of 2-point mounting type

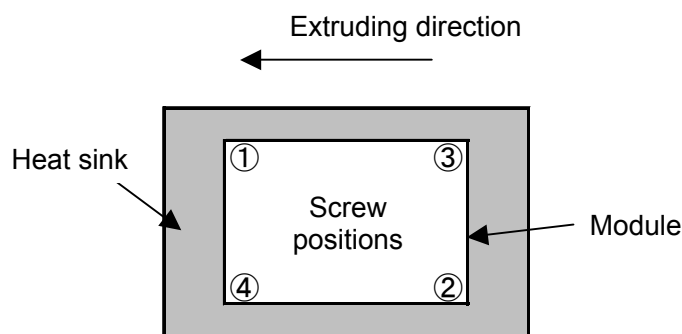

	Torque	Order
1st time (initial tightening)	1/3 of specified torque	(1) (2) (3) (4)
2nd time (permanent tightening)	100% of specified torque	(4) (3) (2) (1)

(2) Case of IPM of 4-point mounting type

Figure 5-3 IPM mounting method

### 3.5 IPM mounting direction

When an IPM is mounted on an extruded heat sink, it is recommended that the IPM is mounted in parallel to the extrusion direction as shown in Figure 5-3. This purpose is to reduce the influence of heat sink deformation.

### 3.6 Verification of chip temperature

After selecting a heat sink and IPM mounting position is decided, measure the temperature at various points on case ( $T_c$ ), heat sink ( $T_f$ ) and junction temperature ( $T_j$ ).

Figure 5-4 shows an example of measuring method for an accurate measurement of case temperature ( $T_c$ ). Please measure the case temperature just below the chip center. The chip location is described in the specification.

Please verify that the chip junction temperature does not exceed  $T_{jmax}$  and the thermal design meets required life time of the system.

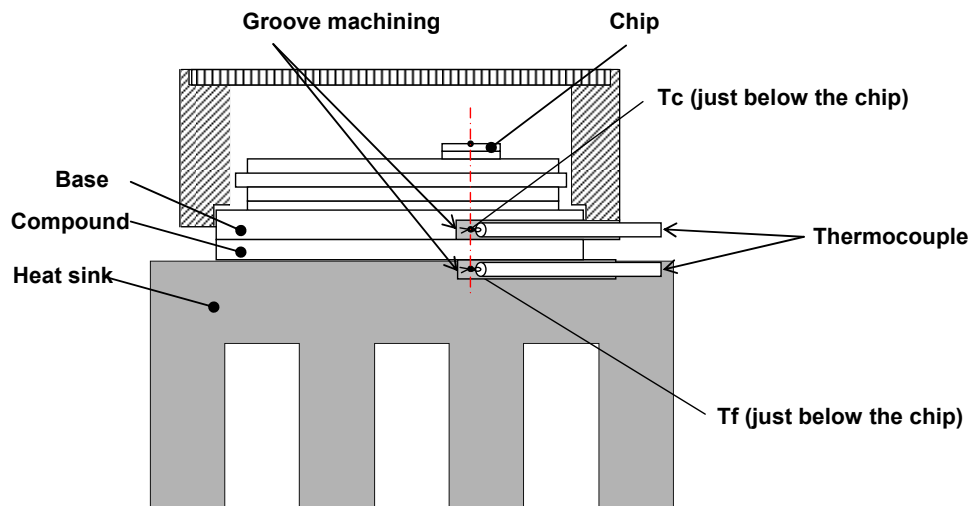

Figure 5-4 Measuring the case temperature