Chapter 7

Trouble Shooting

| Contents | Page |
|---------------------------------------|------|
| 1. Troubleshooting | 7-2 |
| 2. Fault Analysis Diagrams | 7-2 |
| 3. Alarm Cause Analysis Diagram | 7-8 |

1 Trouble Shooting

In comparison to standard modules, IPMs have various protection functions (overcurrent, overheating, etc.) built in, so that their devices are not easily destroyed by abnormal conditions. However, destruction may occur depending on the abnormality, so that countermeasures are required once the cause and state of occurrence have been clarified. An analysis diagram indicating the cause of destruction is shown on page 2 and should be used to investigate the causes of destruction.

(For element fault judgment, refer to the Module Application Manual, chapter 4, item 2 "Fault Judgment Method".)

Also, in the case of alarm output from the IPM, use the alarm cause analysis diagrams of Fig. 7-2 to investigate the cause.

2 Fault Analysis Diagrams

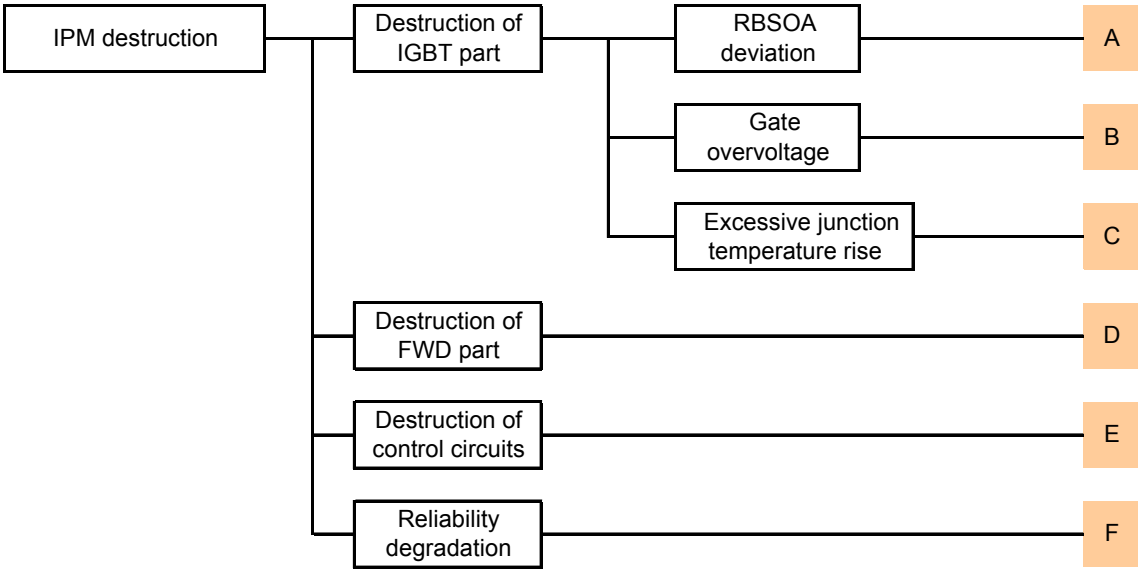

Fig. 7-1 (a.) IPM Fault Analysis Diagram (The letters A to F connect to the following diagrams.)

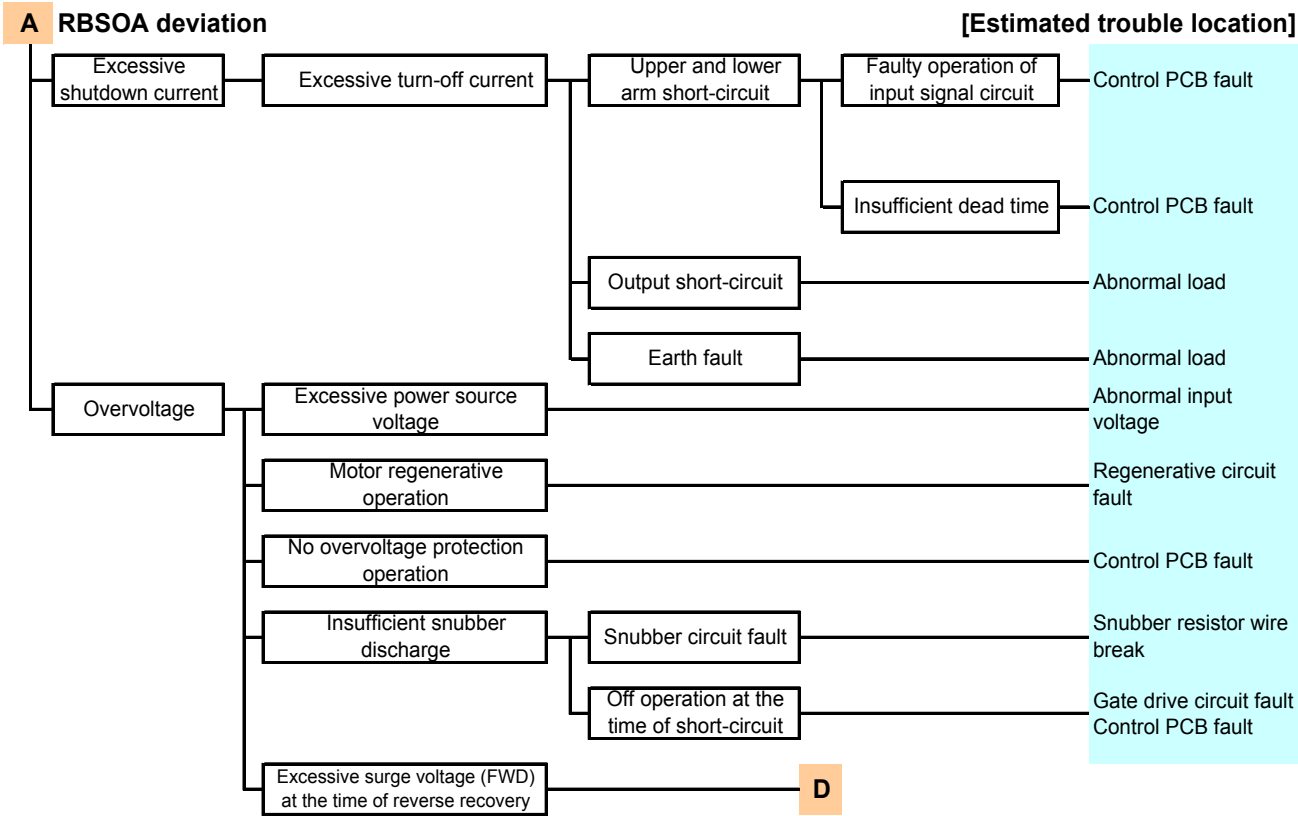

Fig. 7-1 (b) Mode A: RBSOA Deviation

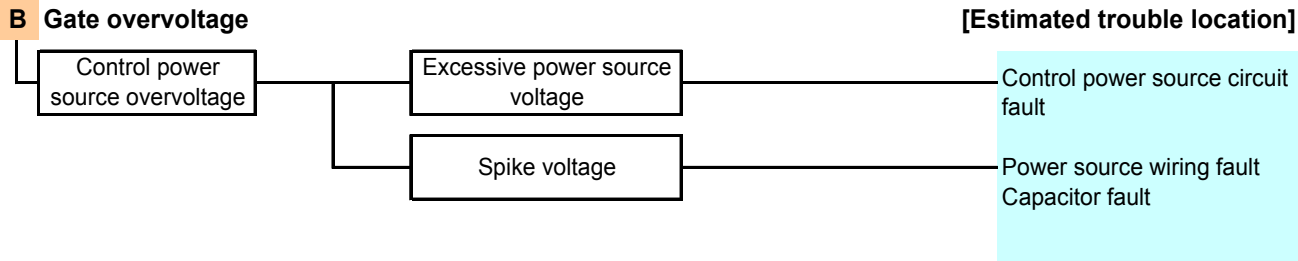

Fig. 7-1 (c) Mode B: Gate Overvoltage

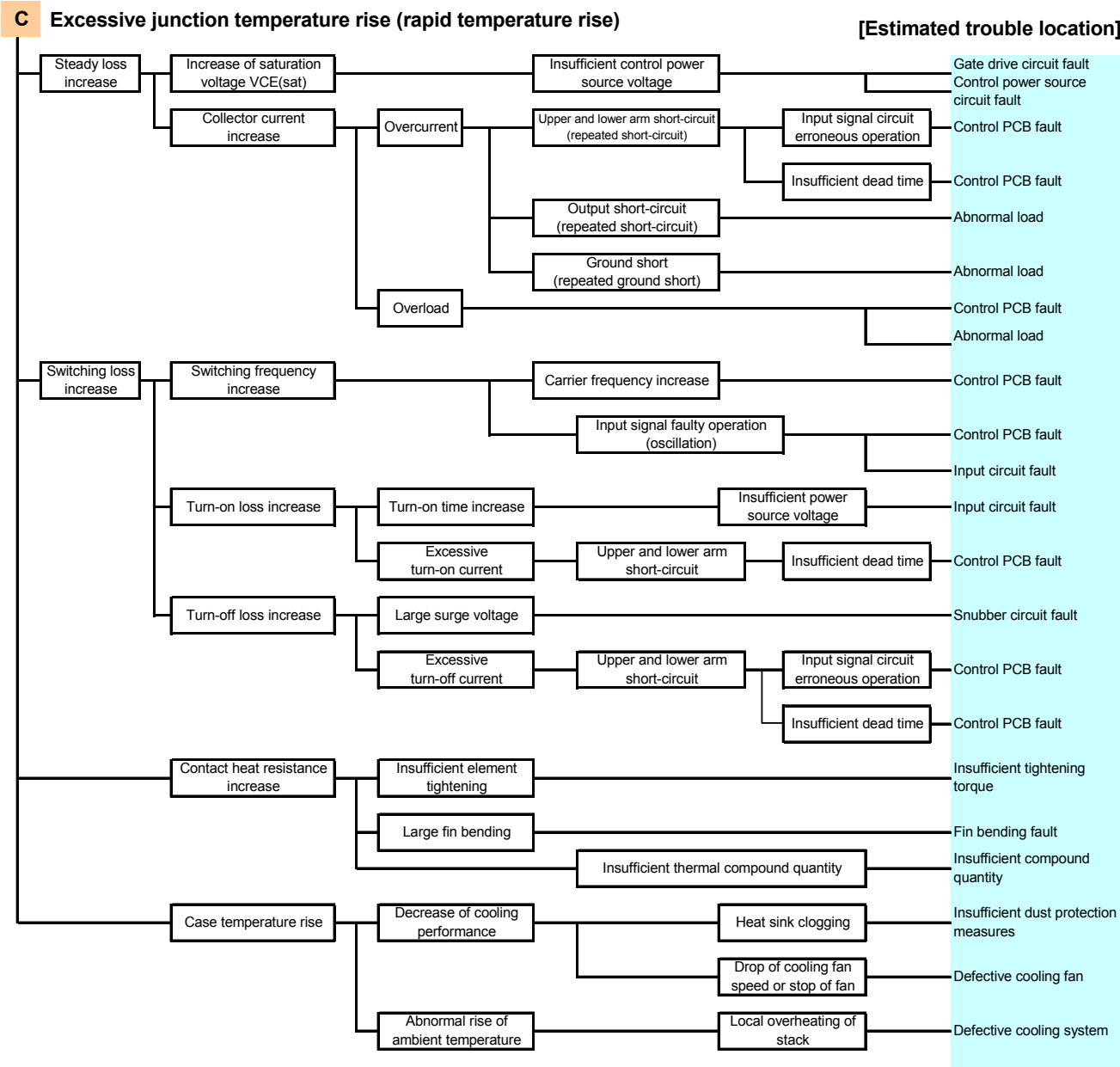

Fig. 7-1 (d) Mode C: Excessive Rise in Junction Temperature

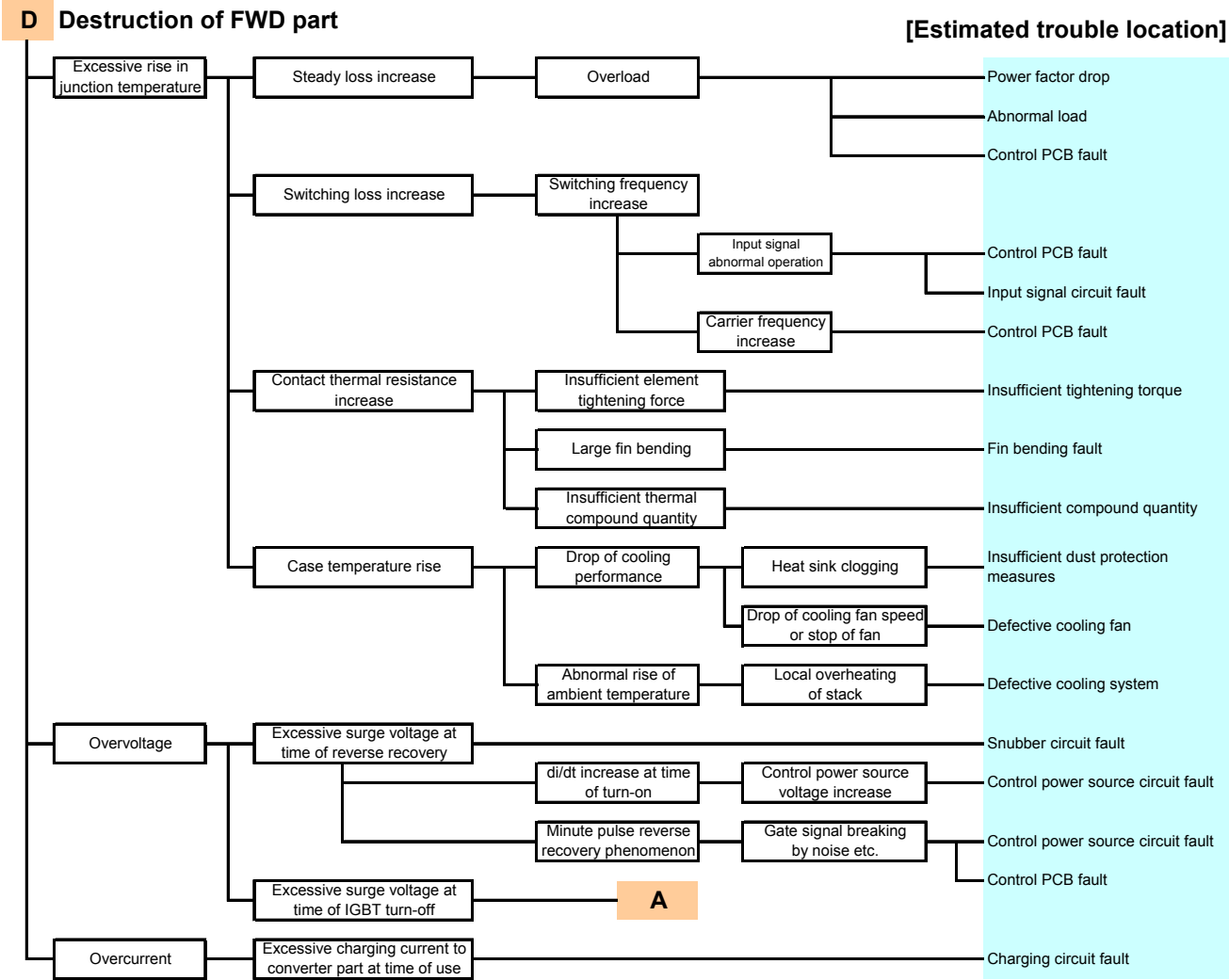

Fig. 7-1 (e) Mode D: Destruction of FWD Part

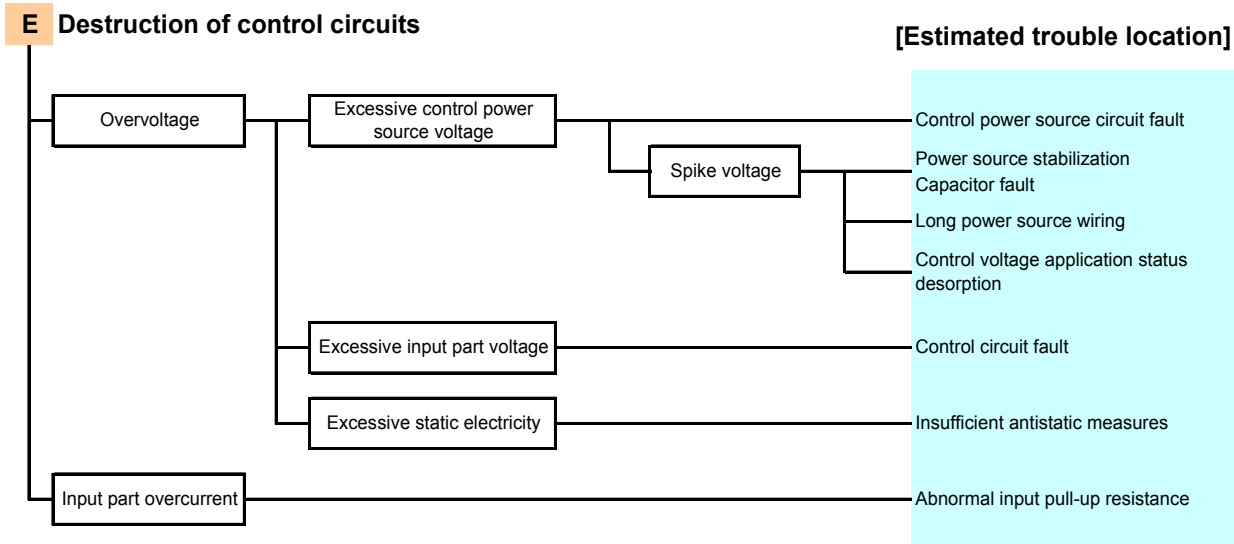

Fig. 7-1 (f) Mode E: Destruction of Control Circuit

F Damage related to reliability and product handling

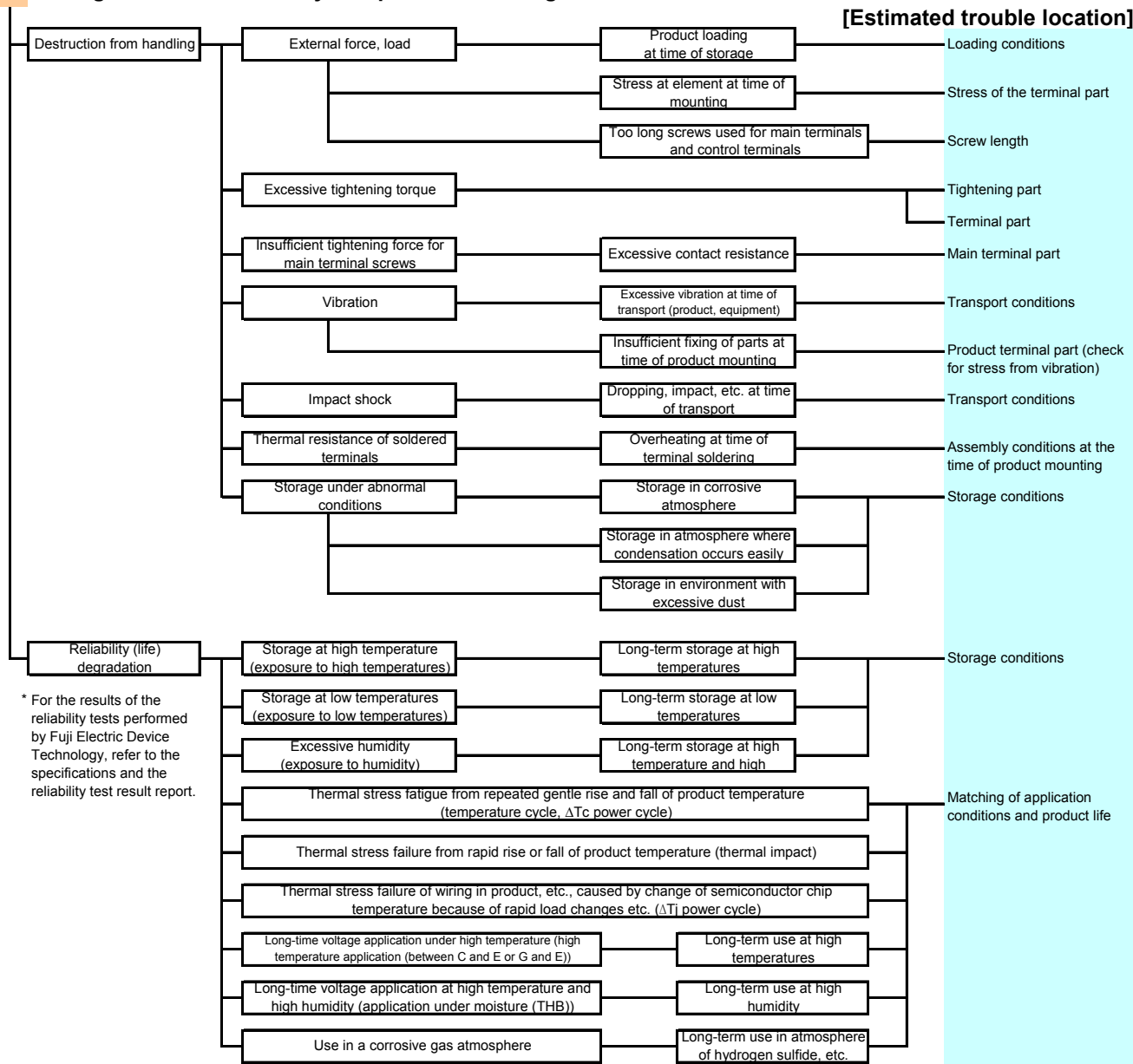

Fig. 7-1 (g) Mode F: Damage Related to Reliability and Product Handling

3 Alarm Cause Analysis Diagram

3.1 Cause analysis in the event an IPM alarm occurs

When an inverter using an IPM comes to an alarm stop, a survey must first be done to find out whether the alarm was output from the IPM or from a device control circuit (other than the IPM).

If the alarm was output by the IPM, determine the cause according to the following cause analysis diagram.

For observation of whether there is an IPM alarm or not via the alarm output voltage, the presence or absence of an alarm output can be confirmed easily by inserting a 1.5 kΩ resistor between the IPM alarm terminal and the cathode of the alarm photodiode and measuring the IPM alarm terminal voltage.

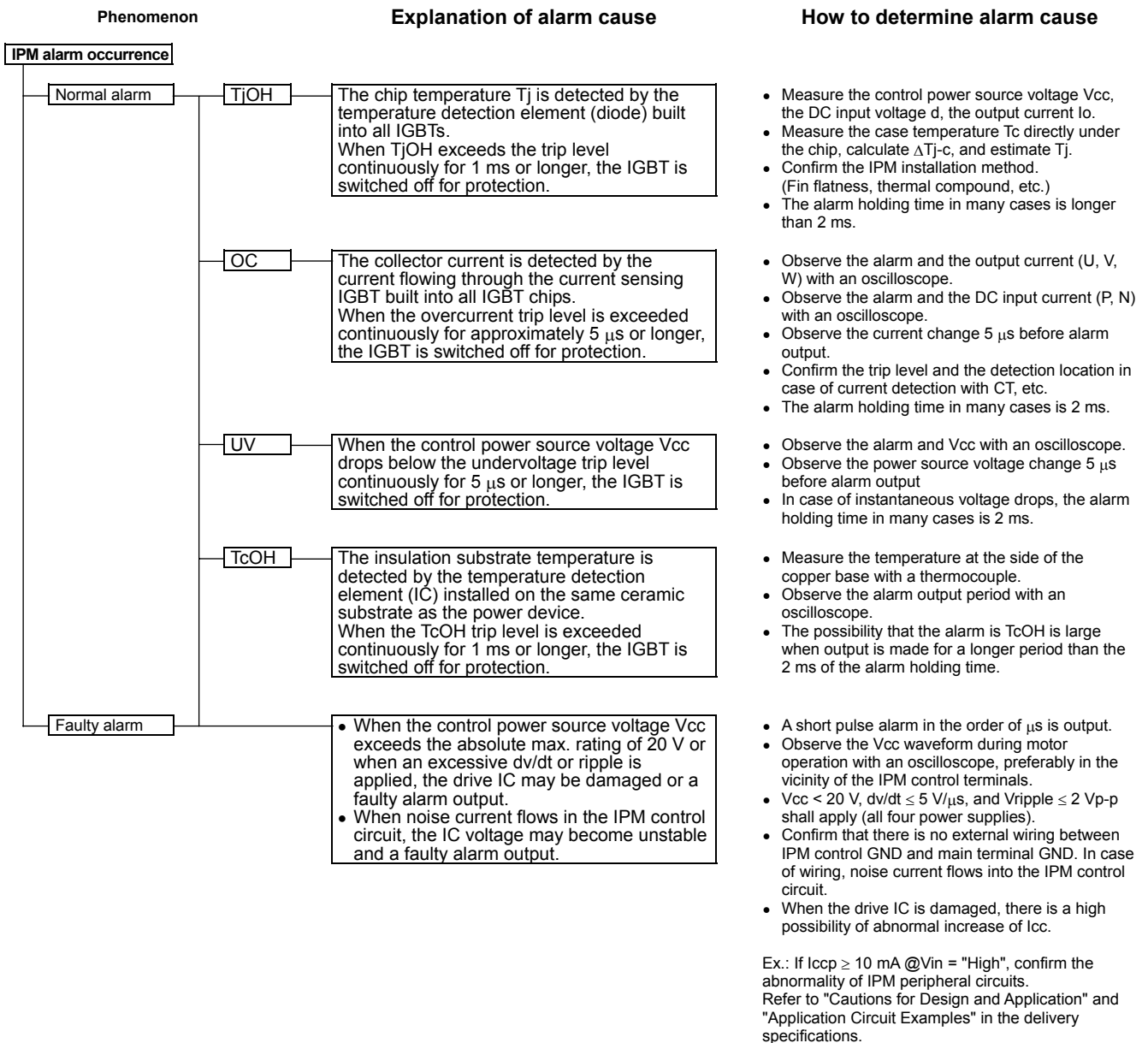

Fig. 7-2 Alarm Cause Analysis Diagram

WARNING

1. This Catalog contains the product specifications, characteristics, data, materials, and structures as of February 2004. The contents are subject to change without notice for specification changes or other reasons. When using a product listed in this Catalog, be sure to obtain the latest specifications.
2. All applications described in this Catalog exemplify the use of Fuji's products for your reference only. No right or license, either express or implied, under any patent, copyright, trade secret or other intellectual property right owned by Fuji Electric Device Technology Co., Ltd. is (or shall be deemed) granted. Fuji Electric Device Technology Co., Ltd. makes no representation or warranty, whether express or implied, relating to the infringement or alleged infringement of other's intellectual property rights which may arise from the use of the applications described herein.
3. Although Fuji Electric Device Technology Co., Ltd. is enhancing product quality and reliability, a small percentage of semiconductor products may become faulty. When using Fuji Electric semiconductor products in your equipment, you are requested to take adequate safety measures to prevent the equipment from causing a physical injury, fire, or other problem if any of the products become faulty. It is recommended to make your design fail-safe, flame retardant, and free of malfunction.
4. The products introduced in this Catalog are intended for use in the following electronic and electrical equipment which has normal reliability requirements.
 - Computers
 - OA equipment
 - Communications equipment (terminal devices)
 - Measurement equipment
 - Machine tools
 - Audiovisual equipment
 - Electrical home appliances
 - Personal equipment
 - Industrial robots etc.
5. If you need to use a product in this Catalog for equipment requiring higher reliability than normal, such as for the equipment listed below, it is imperative to contact Fuji Electric Device Technology Co., Ltd. to obtain prior approval. When using these products for such equipment, take adequate measures such as a backup system to prevent the equipment from malfunctioning even if a Fuji's product incorporated in the equipment becomes faulty.
 - Transportation equipment (mounted on cars and ships)
 - Trunk communications equipment
 - Traffic-signal control equipment
 - Gas leakage detectors with an auto-shut-off feature
 - Emergency equipment for responding to disasters and anti-burglary devices
 - Safety devices
6. Do not use products in this Catalog for the equipment requiring strict reliability such as (without limitation)
 - Space equipment
 - Aeronautic equipment
 - Nuclear control equipment
 - Submarine repeater equipment
 - Medical equipment
7. Copyright © 1996-2004 by Fuji Electric Device Technology Co., Ltd. All rights reserved.
No part of this Catalog may be reproduced in any form or by any means without the express permission of Fuji Electric Device Technology Co., Ltd.
8. If you have any question about any portion in this Catalog, ask Fuji Electric Device Technology Co., Ltd. or its sales agents before using the product.
Neither Fuji Electric Device Technology Co., Ltd. nor its agents shall be liable for any injury caused by any use of the products not in accordance with instructions set forth herein.