

Power factor correction IC FA1A10N power supply design example : 390V/200W

Reference Design

1. Overview

This document describes the design example of PFC circuit using critical conduction mode power-factor correction IC FA1A10N series. The input is universal (85Vac to 264Vac) and the output is 200W.

2. Features

- Low standby power due to no input voltage detection resistors
- High-precision over current protection : $0.6V \pm 2\%$
- Improved power efficiency at light load due to Frequency reduction function
- Power factor improvement function
- Soften Audible Noise at Startup Over Shoot Reduction function
- Low current consumption by CMOS process
- Start-up $500\mu A$ (typ.), Operating $1.5mA$ (typ.)
- Drive circuit for power MOSFET
Output peak current, source : 1000mA, sink : 1000mA
- Short protection at feedback (FB) pin
- Under-voltage Lockout
- Restart timer
- 8-pin package (SOP)

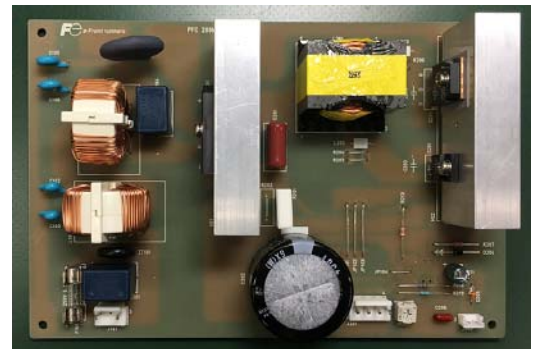

3. Application circuit

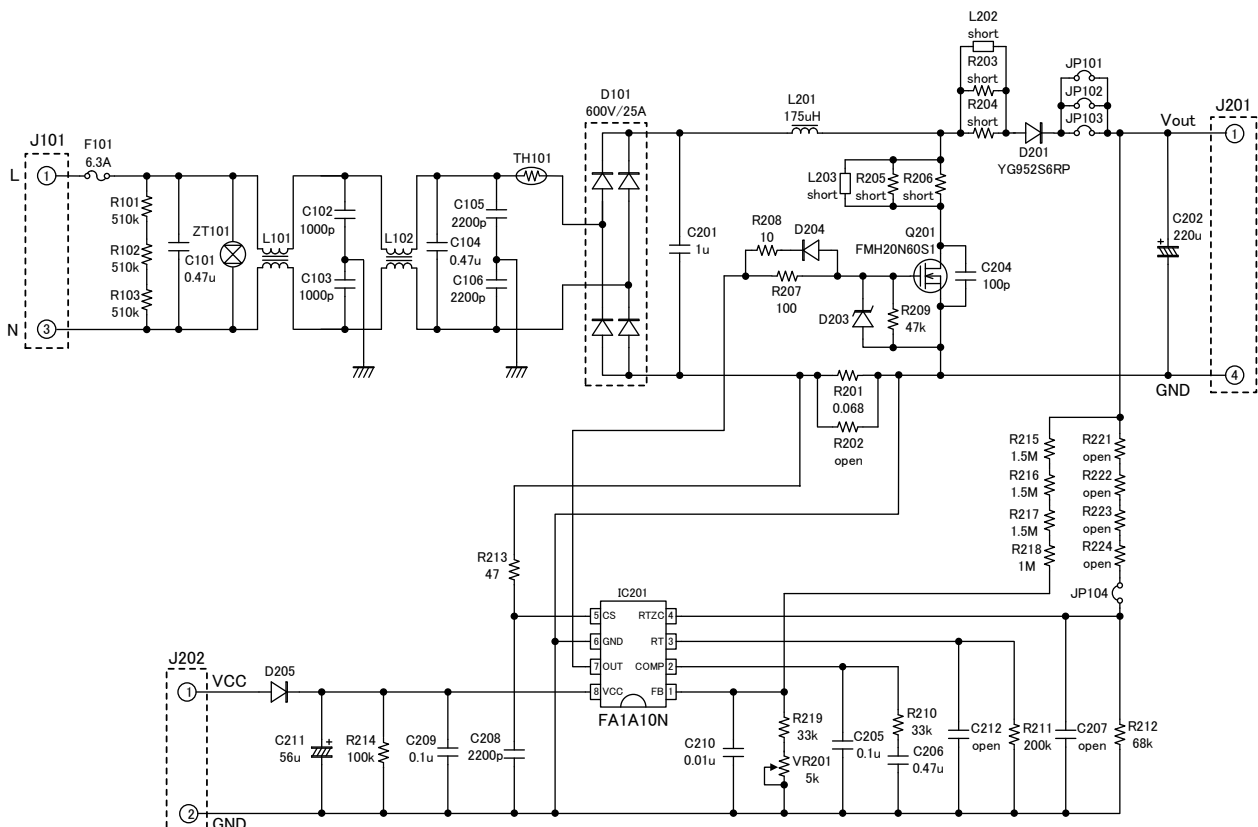

4. Specifications of the power supply

Item	Value	Unit
Input voltage	90 to 264	Vac
Output voltage	390	Vdc
Output power	200	W
Protection function	Overcurrent limiting of power MOSFET Overvoltage limiting Short protection at FB pin Soft Start function	

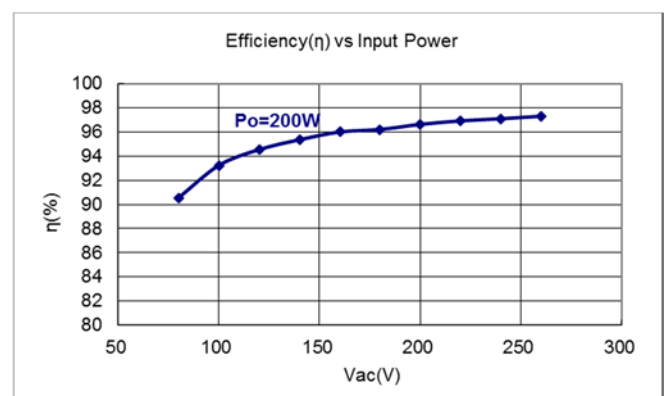
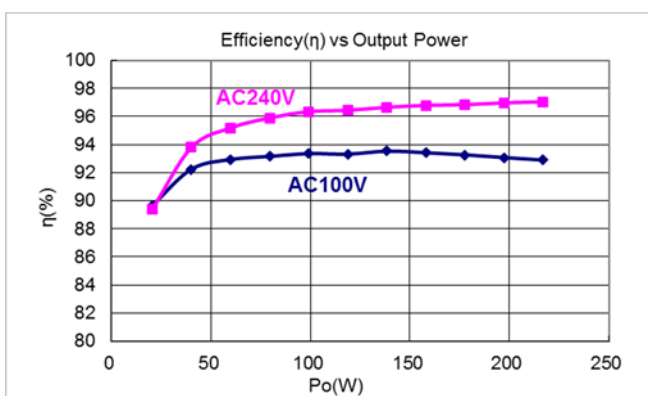
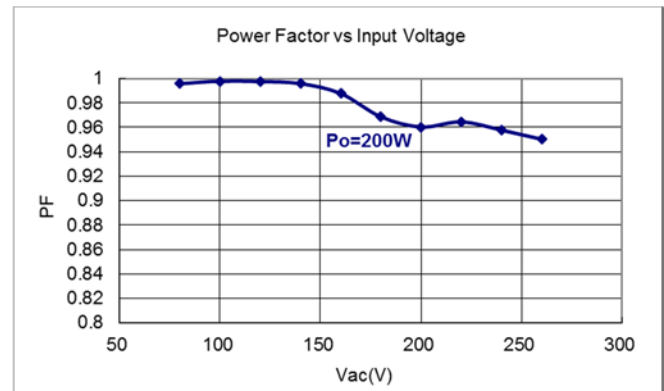
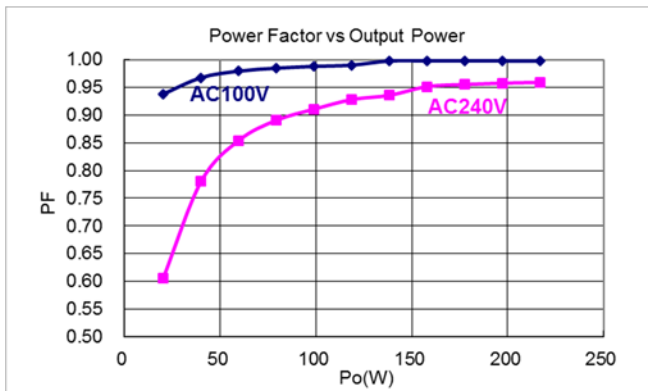
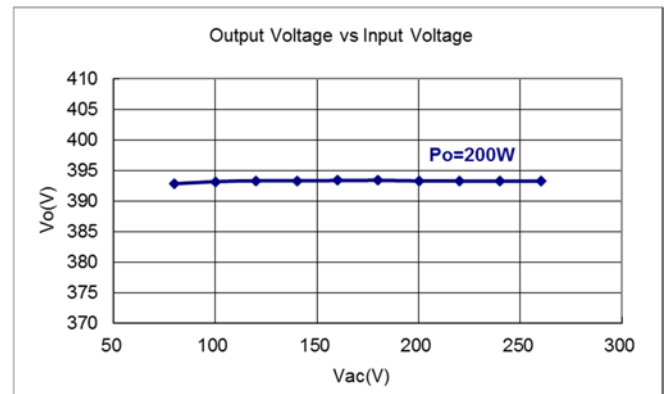
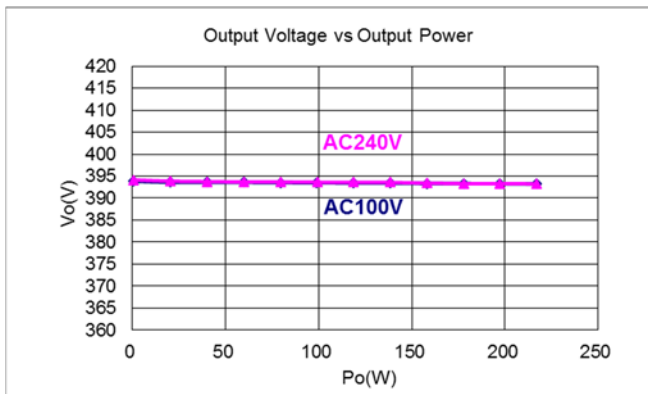
5. Characteristics

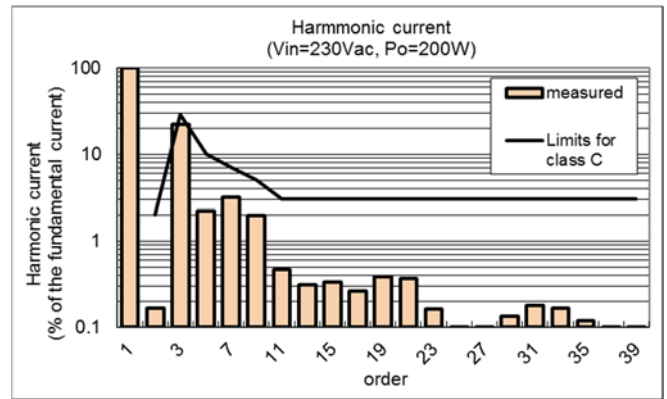
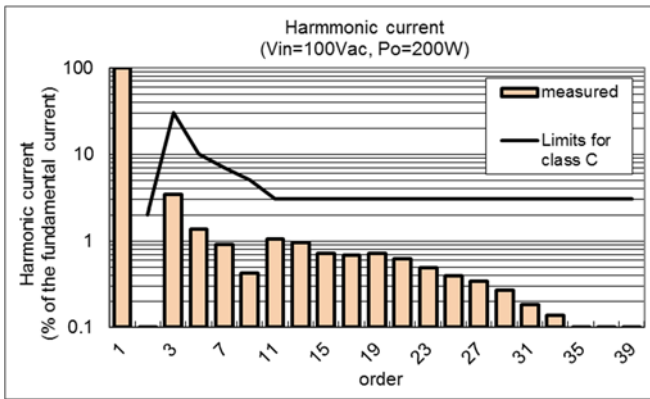

6. Operation waveform (AC input current)

100Vac Po=200W

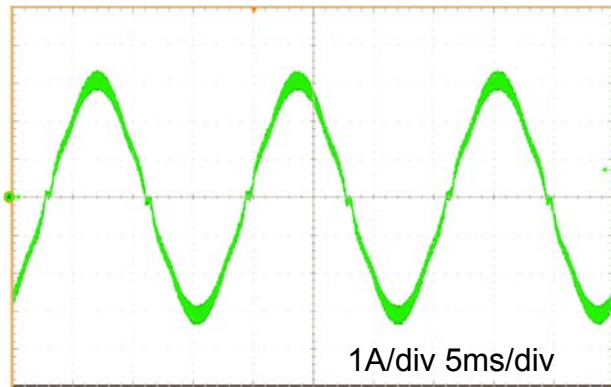

240Vac Po=200W

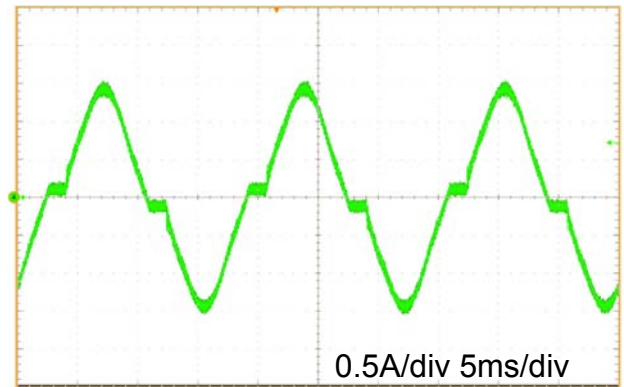

FA1A10N Reference Design
9. Bill of material

Component	Item	Value	Part. No	Maker	Note
IC201	PFC IC		FA1A10N / 11N	Fuji	
Q201	MOSFET		FMH20N60S1	Fuji	
D101	Bridge Diode	600V/25A	D25SB60	SHINDENGEN	
D201	Diode		YG952S6RP	Fuji	
D203	Zenner Diode	27V 0.2W			
D204	Diode		ERA91-002	Fuji	
D205	Diode		1SS244	ROHM	
L101,L102	Inductor	15mH 4A			
L201	Inductor	Lp=175uH			PQ32/30
C101	Film capacitor	AC275V,0.47uF	LE474-M	OKAYA	
C102,C103	Ceramic capacitor	AC250V,1000pF	DE1E3KX102MA4BL01	MURATA	
C104	Film capacitor	AC275V,0.47uF	LE474-M	OKAYA	
C105,C106	Ceramic capacitor	AC250V,2200pF	DE1E3KX222MA4BL01	MURATA	
C201	Film capacitor	630V, 1uF			
C202	Electrolytic capacitor	450V, 270uF			
C204	Ceramic capacitor	2kV,100pF			
C205,C209	Ceramic capacitor	50V, 0.1uF			
C206	Ceramic capacitor	50V, 0.47uF			
C207,C210	Ceramic capacitor	50V, 1000pF			
C208	Ceramic capacitor	50V, 2200pF			
C211	Electrolytic capacitor	50V, 56uF			
R101,R102, R103	Resister	1/8W, 510kΩ			
R201	Resister	3W, 0.068Ω			
R207	Resister	1/4W, 100Ω			
R208	Resister	1/4W, 10Ω			
R209	Resister	1/8W, 47kΩ			
R210	Resister	1/8W, 33kΩ			
R211	Resister	1/8W, 200kΩ			
R212	Resister	1/8W, 68kΩ			
R213	Resister	1/8W, 47Ω			
R214	Resister	1/8W, 100kΩ			
R215,R216, R217	Resister	1/8W, 1.5MΩ			
R218	Resister	1/8W, 1MΩ			
R219	Resister	1/8W, 33kΩ			
R221	Resister	1/8W, 2.2MΩ			
R224	Resister	1/8W, 390kΩ			
VR201	Variable Resistor	5kΩ			
F101	Fuse	AC250V 6.3A			
ZT101	Transient/Surge Absorber	SVR471D10			
TH101	Thermistor	3D-22			
J101	Connector	B2P3-VH		JST	
J201	Connector	B4P-VH		JST	
J202	Connector	B2B-EH		JST	

Notice

1. The contents of this note (Product Specification, Characteristics, Data, Materials, and Structure etc.) were prepared in Mar, 2019. The contents will subject to change without notice due to product specification change or some other reasons. In case of using the products stated in this document, the latest product specification shall be provided and the data shall be checked.
2. The application examples in this note show the typical examples of using Fuji products and this note shall neither assure to enforce the industrial property including some other rights nor grant the license.
3. Fuji Electric Co., Ltd. is always enhancing the product quality and reliability. However, semiconductor products may get out of order in a certain probability. Measures for ensuring safety, such as redundant design, spreading fire protection design, malfunction protection design shall be taken, so that Fuji Electric semiconductor product may not cause physical injury, property damage by fire and social damage as a result.
4. Products described in this note are manufactured and intended to be used in the following electronic devices and electric devices in which ordinary reliability is required:
 - Computer - OA equipment - Communication equipment (Pin) - Measuring equipment
 - Machine tool - Audio Visual equipment - Home appliance - Personal equipment
 - Industrial robot etc.
5. Customers who are going to use our products in the following high reliable equipments shall contact us surely and obtain our consent in advance. In case when our products are used in the following equipment, suitable measures for keeping safety such as a back-up-system for malfunction of the equipment shall be taken even if Fuji Electric semiconductor products break down:
 - Transportation equipment (in-vehicle, in-ship etc.) - Communication equipment for trunk line
 - Traffic signal equipment - Gas leak detector and gas shutoff equipment
 - Disaster prevention/Security equipment - Various equipment for the safety.
6. Products described in this note shall not be used in the following equipments that require extremely high reliability:
 - Space equipment - Aircraft equipment - Atomic energy control equipment
 - Undersea communication equipment - Medical equipment.
7. When reprinting or copying all or a part of this note, our company's acceptance in writing shall be obtained.
8. If obscure parts are found in the contents of this note, contact Fuji Electric Co., Ltd. or a sales agent before using our products. Fuji Electric Co., Ltd. and its sales agents shall not be liable for any damage that is caused by a customer who does not follow the instructions in this cautionary statement.

- The contents will subject to change without notice due to product specification change etc.
- Application examples and component in this sheet is for the purpose of assisting in the design. Therefore, This sheet has not been made in consideration of the margin.
- Before using, Please design in consideration of the parts variation and use condition.