

FUJI Small-IPM X-series

Consumption current of control supply circuit vs. carrier frequency

This document shows the consumption current of control supply circuit vs. carrier frequency. Please design the power supply with sufficient margin in consideration of the consumption current.

Current measurement:

Consumption current of low-side control supply I_{CCL}

Consumption current of high-side control supply I_{CCH}

Total consumption current of U,V,W phase of bootstrap circuit I_{CCHB}

Total consumption current of control supply $I_{TOTAL} = I_{CCL} + I_{CCH} + I_{CCHB}$

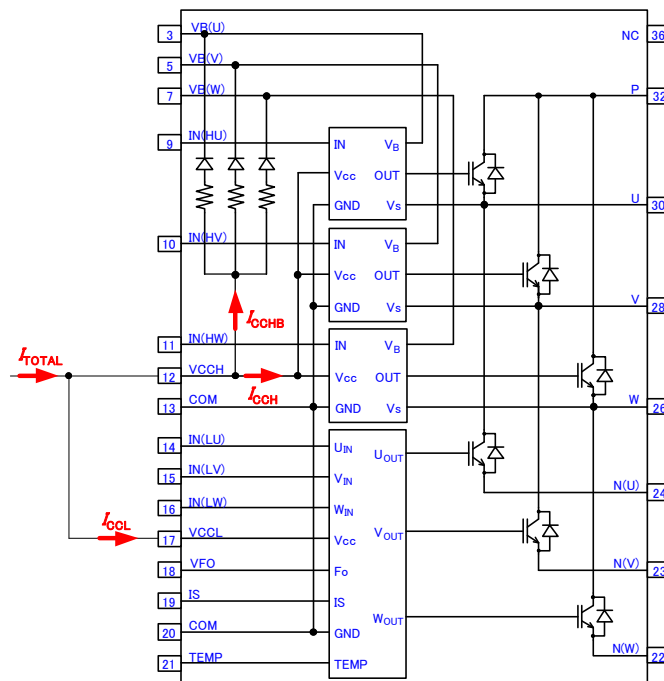

Measurement condition:

- 2 phase modulation, 3 phase modulation
- $V_{DC}=400V$, $V_{CCL}=V_{CCH}=V_B(*)=15V$, $T_c=25^\circ C$, no-load

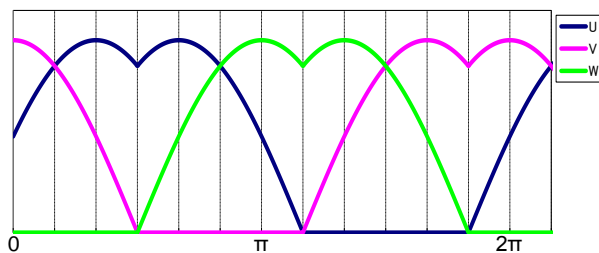

Modulation wave (2 phase)

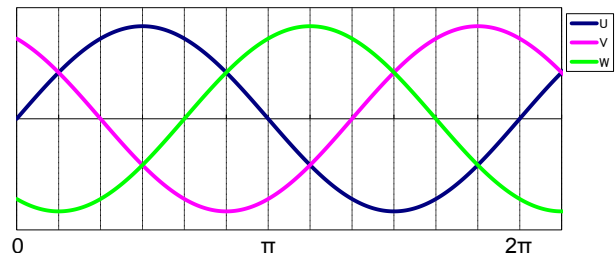

Modulation wave (3 phase)

Type name: 6MBP15XSD060-50, 6MBP15XSD060-50-F1

6MBP15XSF060-50, 6MBP15XSF060-50-F1

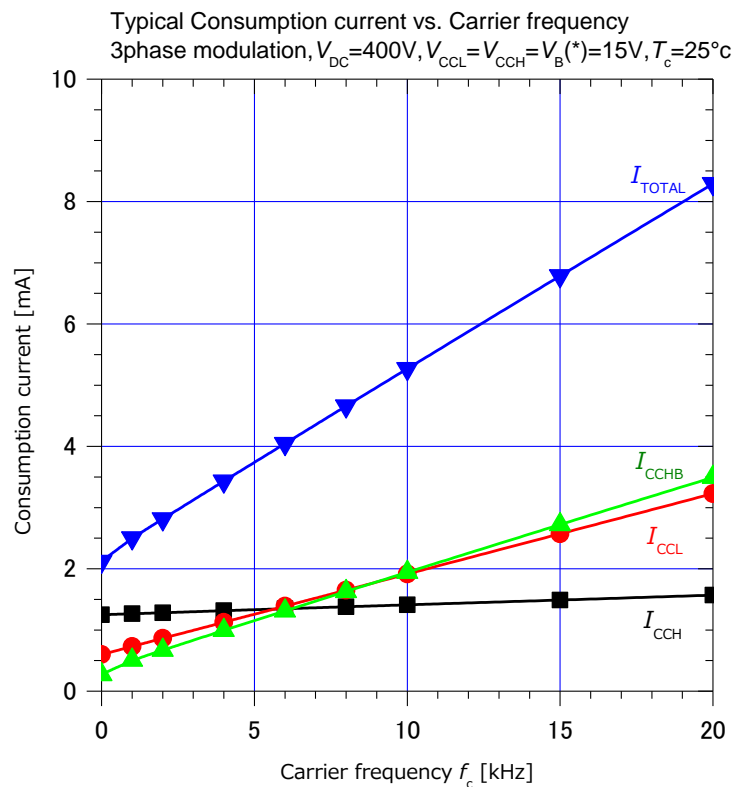
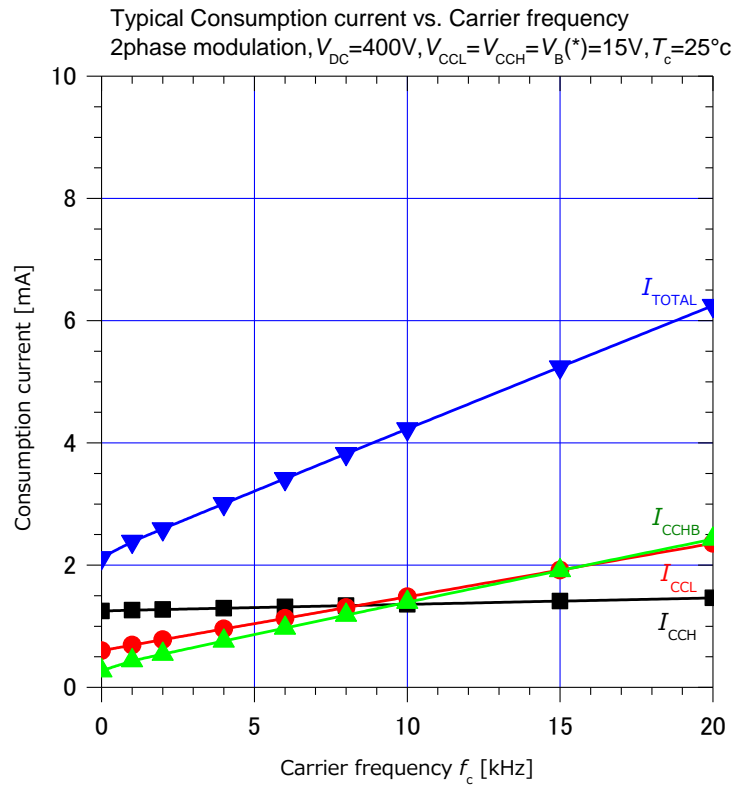

Type name: 6MBP20XSD060-50, 6MBP20XSD060-50-F1

6MBP20XSF060-50, 6MBP20XSF060-50-F1

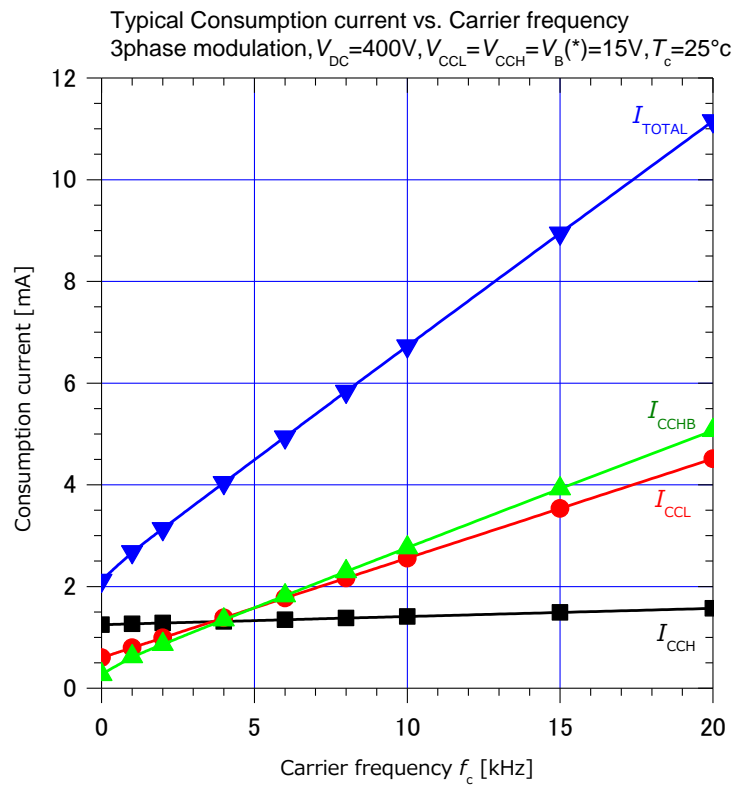
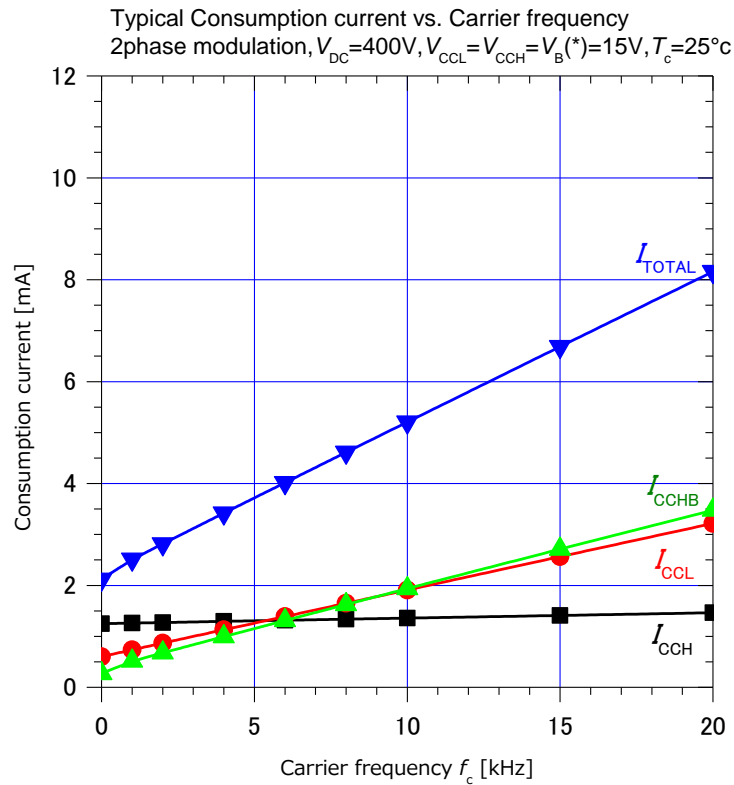

Type name: 6MBP30XSD060-50, 6MBP30XSD060-50-F1

6MBP30XSF060-50, 6MBP30XSF060-50-F1

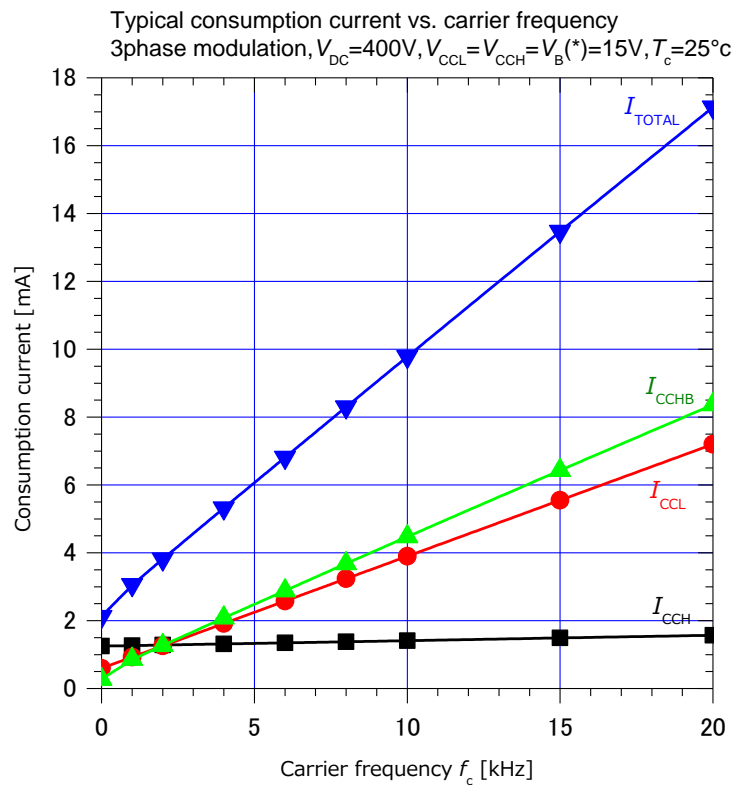
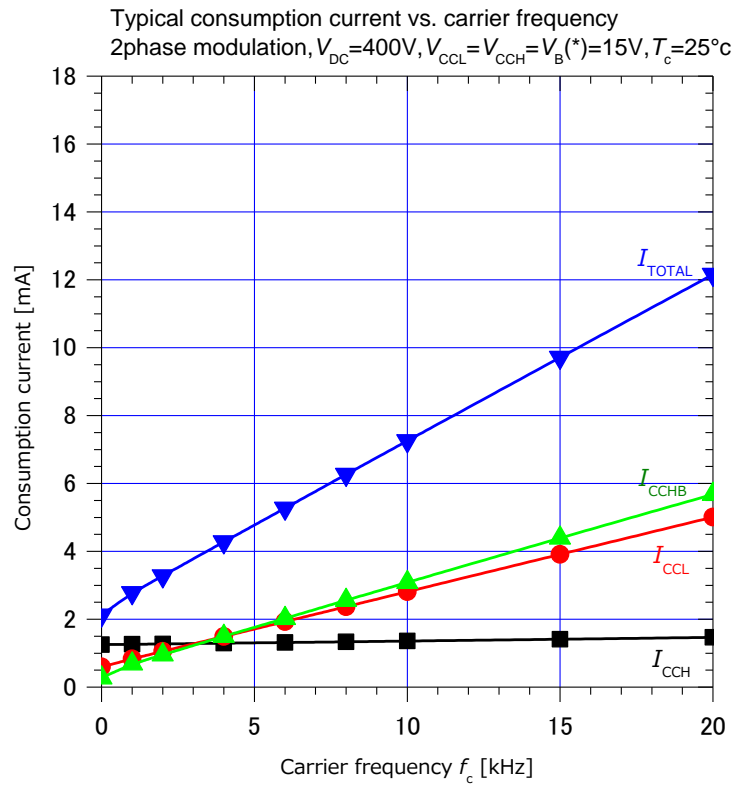

Type name: 6MBP35XSD060-50, 6MBP35XSD060-50-F1
 6MBP35XSF060-50, 6MBP35XSF060-50-F1

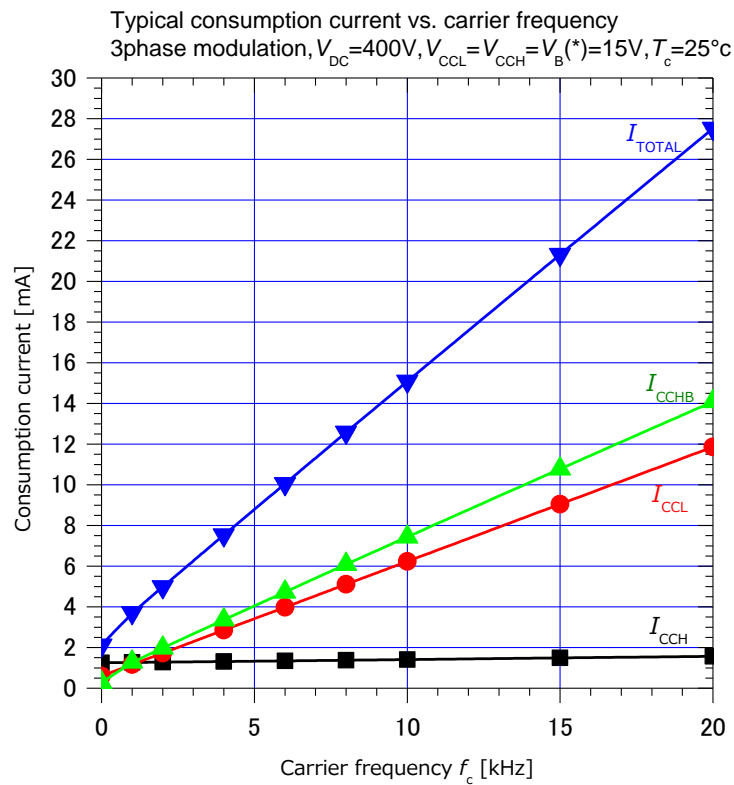
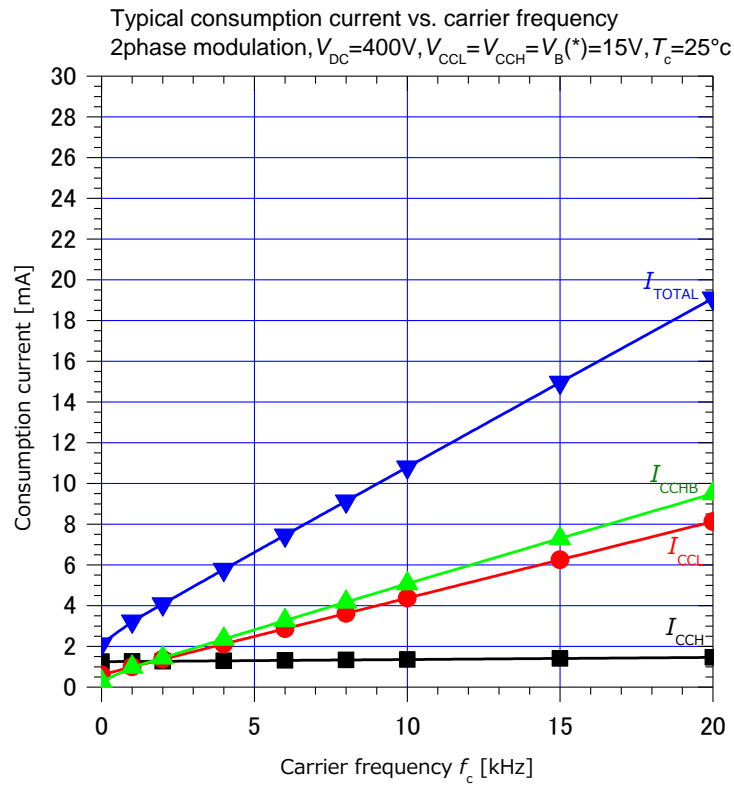

WARNING

1. This Catalog contains the product specifications, characteristics, data, materials, and structures as of February 2018. The contents are subject to change without notice for specification changes or other reason. When using a product listed in this Catalog, be sure to obtain the latest specifications.
2. All applications described in this Catalog exemplify the use of Fuji's products for your reference only. No right or license, either express or implied, under any patent, copyright, trade secret or other intellectual property right owned by Fuji Electric Co., Ltd. is (or shall be deemed) granted. Fuji Electric Co., Ltd. makes no representation or warranty, whether express or implied, relating to the infringement or alleged infringement of other's intellectual property rights which may arise from the use of the applications described herein.
3. Although Fuji Electric Co., Ltd. is enhancing product quality and reliability, a small percentage of semiconductor products may become faulty. When using Fuji Electric semiconductor products in your equipment, you are requested to take adequate safety to prevent the equipment from causing a physical injury, fire, or other problem if any of the products become faulty. It is recommended to make your design failsafe, flame retardant, and free of malfunction.
4. The products introduced in this Catalog are intended for use in the following electronic and electrical equipment which has normal reliability requirements.
 - Computers •OA equipment •Communications equipment (terminal devices) •Measurement equipment
 - Machine tools •Audiovisual equipment •Electrical home appliances •Personal equipment •Industrial robots etc
5. If you need to use a product in this Catalog for equipment requiring higher reliability than normal, such as for the equipment listed below, it is imperative to contact Fuji Electric Co., Ltd. to obtain prior approval. When using these products for such equipment, take adequate measures such as a backup system to prevent the equipment from malfunctioning even if a Fuji's product incorporated in the equipment becomes faulty.
 - Transportation equipment (mounted on cars and ships) •Trunk communications equipment
 - Traffic-signal control equipment •Gas leakage detectors with an auto-shut-off feature
 - Emergency equipment for responding to disasters and anti-burglary devices •Safety devices
 - Medical equipment.
6. Do not use products in this Catalog for the equipment requiring strict reliability such as the following and equivalents to strategic equipment (without limitation).
 - Space equipment •Aeronautic equipment •Nuclear control equipment •Submarine repeater equipment
7. All rights reserved. No part of this Catalog may be reproduced without permission in writing from Fuji Electric Co., Ltd.
8. If you have any question about any portion in this Catalog, ask Fuji Electric Co., Ltd. or its sales agents before using the product. Neither Fuji Electric Co., Ltd. nor its agents shall be liable for any injury caused by any use of the products not in accordance with instructions set forth herein.