Sixth-Generation V-Series IGBT Module

Application Note

Chapter 2

– Precautions for Use –

Table of contents		Page
1	Maximum bonding temperature of 175°C	2-2
2	Short-circuit (overcurrent) protection	2-2
3	Overvoltage protection and safe operating area	2-4
4	Drive conditions and dead time setting	2-12
5	Parallel connection	2-14
6	Downsizing of package	2-16
7	Series of solder-free mounting modules	2-17
8	Mounting instructions	2-17

Introduction

The sixth-generation V-series IGBT module has advanced field stop (FS) structure and the trench gate structure which are originally developed for the fifth-generation U-series. Thickness and the trench structure optimization were also done to realize performance improvement.

This chapter describes the precautions for use of the sixth-generation V-series IGBT module.

1 Maximum bonding temperature of 175°C

– Merits and precautions for application of $T_j(\text{max})=175^\circ\text{C}$ –

The maximum junction temperature of sixth-generation V series is 175°C, 25°C upgrade has been achieved from the fifth-generation (U and U4 series) and other conventional series of ax. junction temperature of 150°C.

In the previous generation, the IGBT modules are used at the continuous operating temperature ($T_j(\text{op})$) of around 125°C taking into account of the design margin from $T_j(\text{max})$ of 150°C. In V series, however, $T_j(\text{max})$ is now 175°C and the module can be guaranteed for the continued operation at 150°C based on the verification tests conducted according to the JEITA standards.

Therefore, new generation has impacts in many advantages of such as expansion of applicable range of inverter, downsizing of applicable module and cooling fan, and improvement of output current and carrier frequency.

For those reasons, in the sixth-generation V-series module, since the maximum junction temperature $T_{jop}(\text{max})$ is 150°C, the operating conditions have to be decided so that the temperature is below 150°C. In practical operation of the drive systems, for example, overload operations are inevitable for a specific short period. In such a case, temperature up to $T_j(\text{max})$ of 175°C can be used.

On the other hand, since the maximum temperature during continuous operation is 150°C, continuous operation at over temperature may results unlikely degradation in product lifetime such as power cycle capability.

2 Short-circuit (overcurrent) protection

If IGBT is short-circuited, the voltage across the collector and the emitter (between C–E) is increased suddenly when the current of IGBT collector exceeds the specified value. Although the collector current will be saturated to a specific value or lower due to self saturation feature of IGBT structure, the critical duty of high voltage and current are applied to IGBT. This situation must be removed as quickly as possible.

Figures 1-1 and 1-2 show the relation between the short circuit capacity (guaranteed short-circuit duration) and the applied voltage when short circuit occurs in V series of 1200V and 600V. For setting of short-circuit detection time, refer to operating conditions of application and this relation.

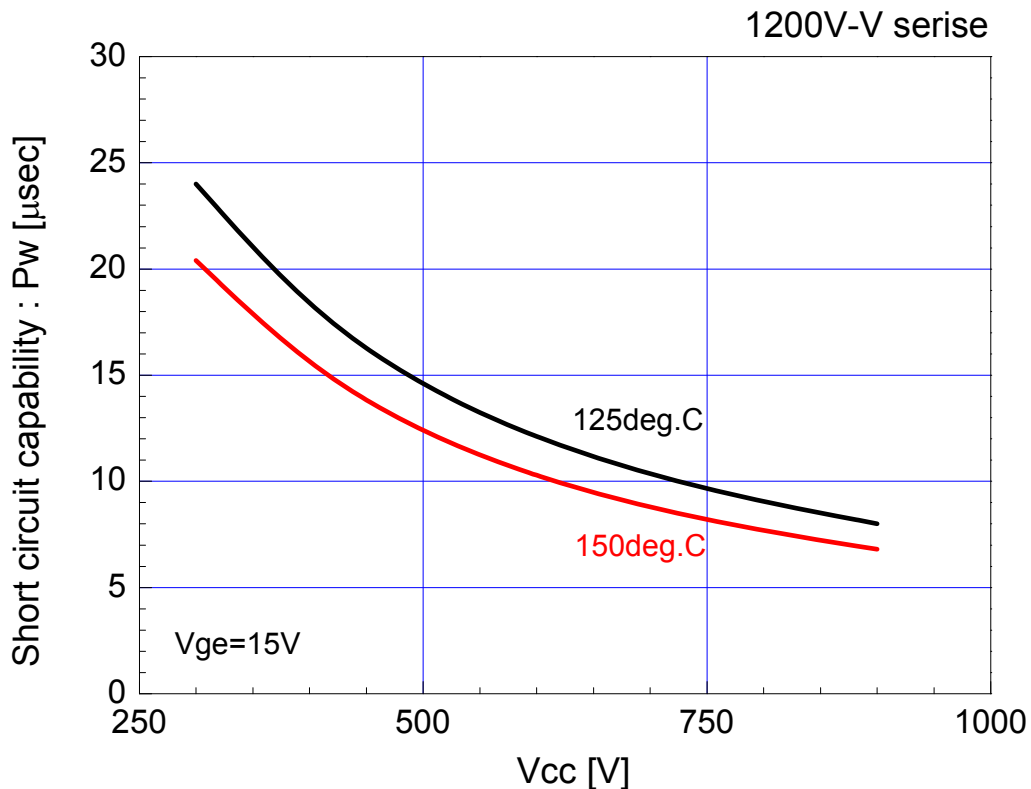

Fig. 1-1 Relation between Short Circuit Capacity and Applied Voltage when Short Circuit Occurs in V Series of 1200V

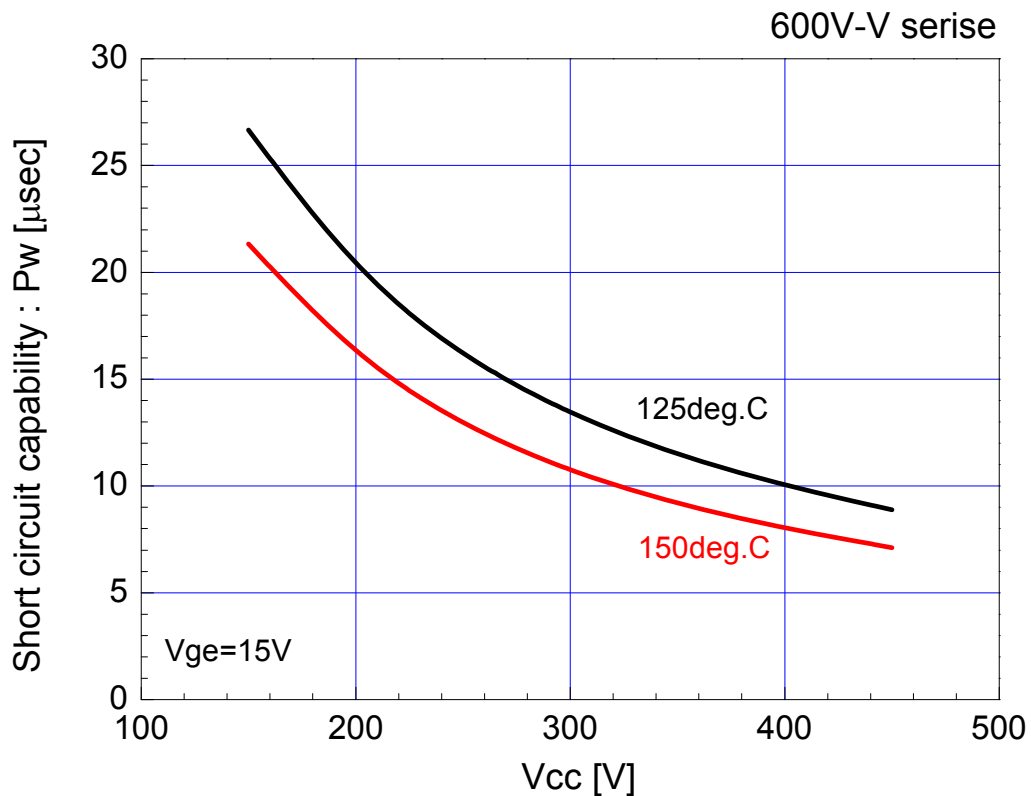

Fig. 1-2 Relation between Short Circuit Capacity and Applied Voltage when Short Circuit Occurs in V Series of 600V

3 Overvoltage protection and safe operating area

3.1 Overvoltage protection

High di/dt is often observed when IGBT is turned off or at reverse recovery of FWD because the switching speed of IGBT is fast, and surge voltage is generated due to di/dt and the wiring parasitic inductance in the main circuit. If this surge voltage exceeds the maximum rated voltage, overvoltage is applied to IGBT and in the worst case it may be destroyed. To prevent the device failure, a combination of widely used snubber circuit, gate resistance R_g adjustment and reduce inductance of the main circuit are recommended.

Figure 2-1 shows the outline drawing of turnoff waveforms and reverse recovery waveforms as well as the definition of surge voltage. As shown in the figure, V_{CEP} is defined as IGBT surge voltage and V_{AKP} as at FWD reverse recovery surge voltage. V_{CEP} and V_{AKP} indicated in the figures of this section are used in this definition.

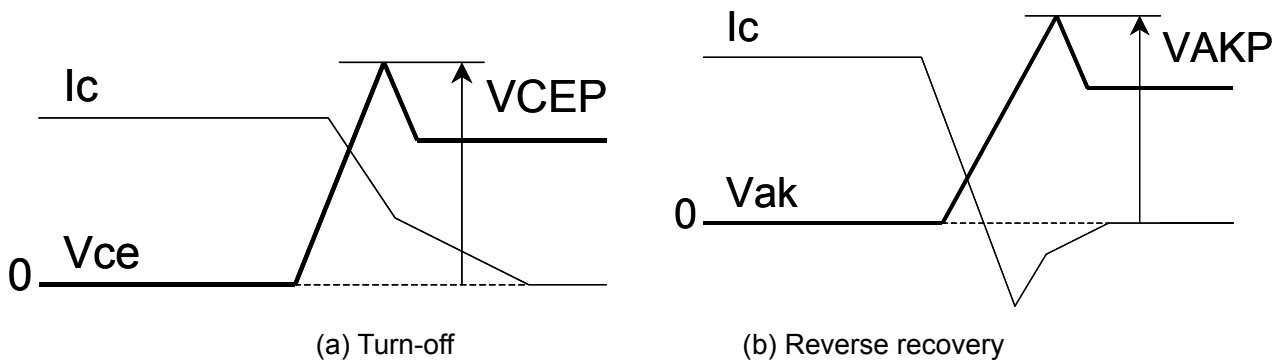

Fig. 2-1 Outline Drawing of IGBT Turn-off Waveform and FWD Reverse Recovery Waveform and Surge Voltage

As actual characteristics of surge voltage, an example of surge voltage characteristic in V-series IGBT module 2MBI450VN-120-50 is shown below.

Figure 2-2 shows one example of stray inductance (L_s) dependence of surge voltage at turn off and reverse recovery. As shown, when stray inductance is high, the surge voltage is high. In this example, especially the influence on the turnoff surge is significant.

Figure 2-3 shows one example of collector voltage dependence of surge voltage when IGBT is turned off and at FWD reverse recovery. The surge voltage becomes higher when the collector voltage dependence is higher.

Figure 2-4 shows one example of current dependence of surge voltage when IGBT is turned off and at FWD reverse recovery. In general, the surge voltage at IGBT turned off tends to be higher when the collector current is larger. On the other hand, the high reverse recovery surge voltage of FWD typically be found in low current switching. The maximum value of it appears in the low current area in a fraction of the rated current.

Figure 2-5 shows one example of gate resistance dependence of surge voltage at FWD reverse recovery. The low current of 45A and the rated current of 450A are shown as current conditions. This figure shows that the surge voltage becomes higher when current is low and gate resistance is low.

As shown above, the value of surge voltage generated in the IGBT module changes significantly depending on not only the above main circuit inductance and gate drive conditions but also the capacitor capacity, gate drive capacity, and use and circuit conditions such as type of snubber circuit.

Therefore, it is recommended to make sure that the surge voltage is kept within RBSOA for all possible operating conditions of respective devices such as inverter system that uses the module. If the surge voltage exceeds the specified RBSOA, it should be reduced by adjusting the gate resistance, reducing the stray inductance or adding a snubber circuit. In case of controlling the surge voltage by adjusting the gate resistance, it is recommended to select the optimal drive conditions by selecting gate resistance for the on side and off side separately.

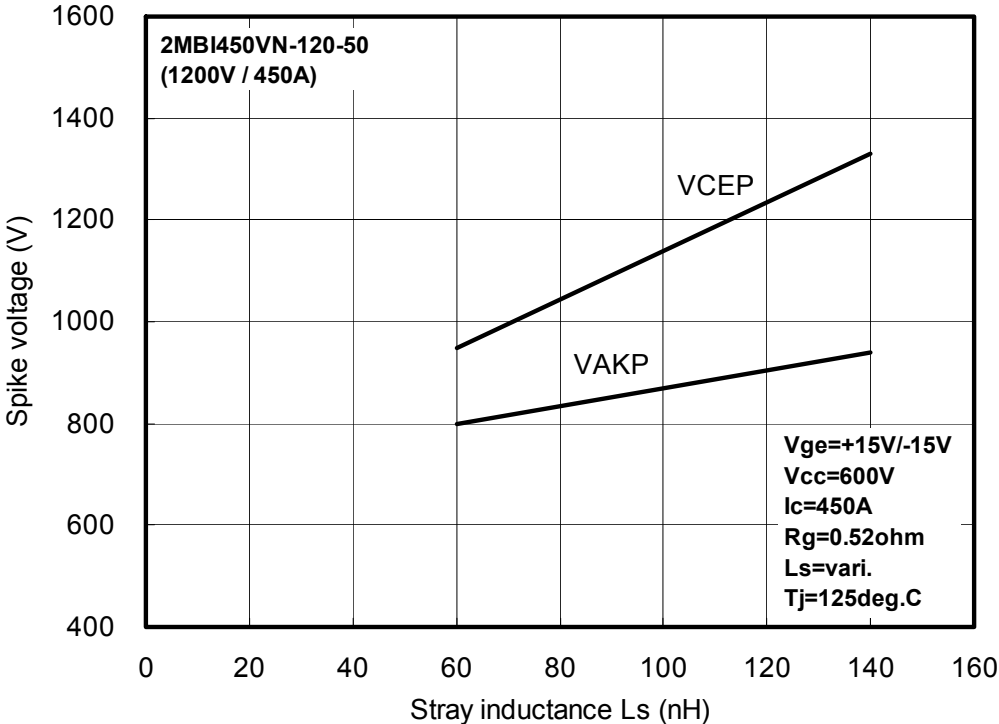

Fig. 2-2 Example of Stray Inductance Dependence of Surge Voltage at IGBT Turn-Off and FWD Reverse Recovery

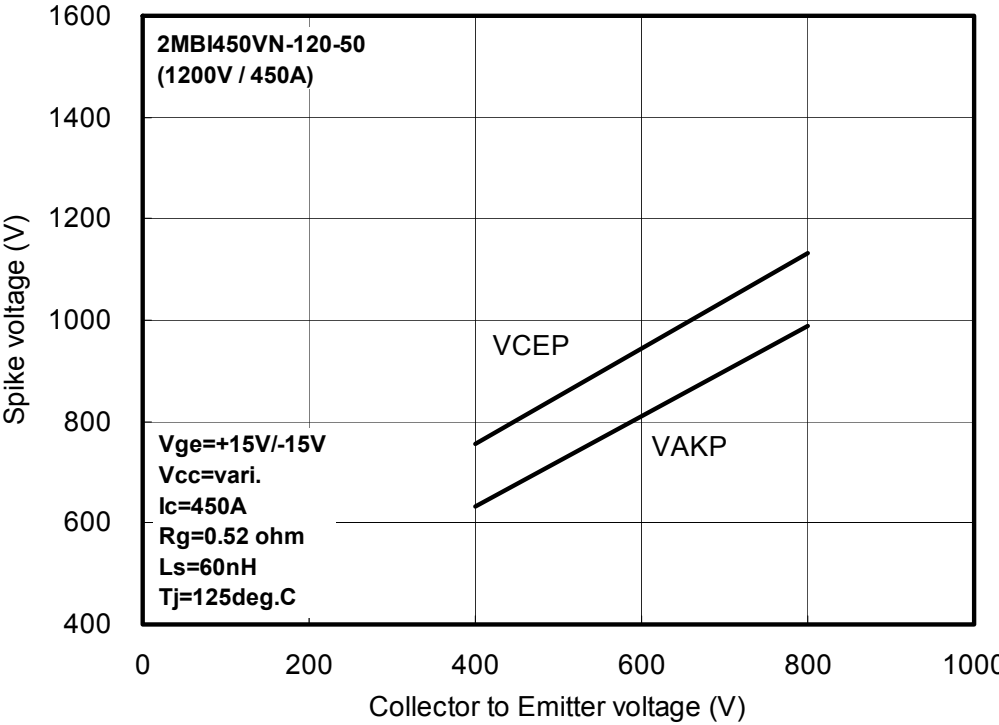

Fig. 2-3 Example of Collector Voltage Dependence of Surge Voltage at IGBT Turn-Off and FWD Reverse Recovery

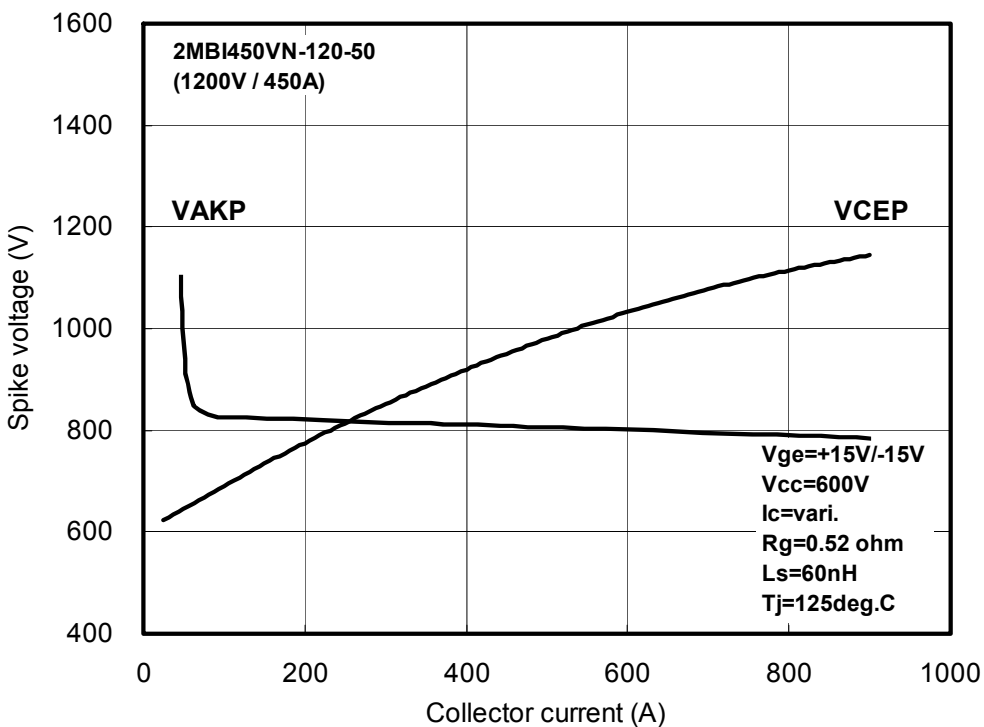

Fig. 2-4 Example of Current Dependence of Surge Voltage at IGBT Turn-Off and FWD Reverse Recovery

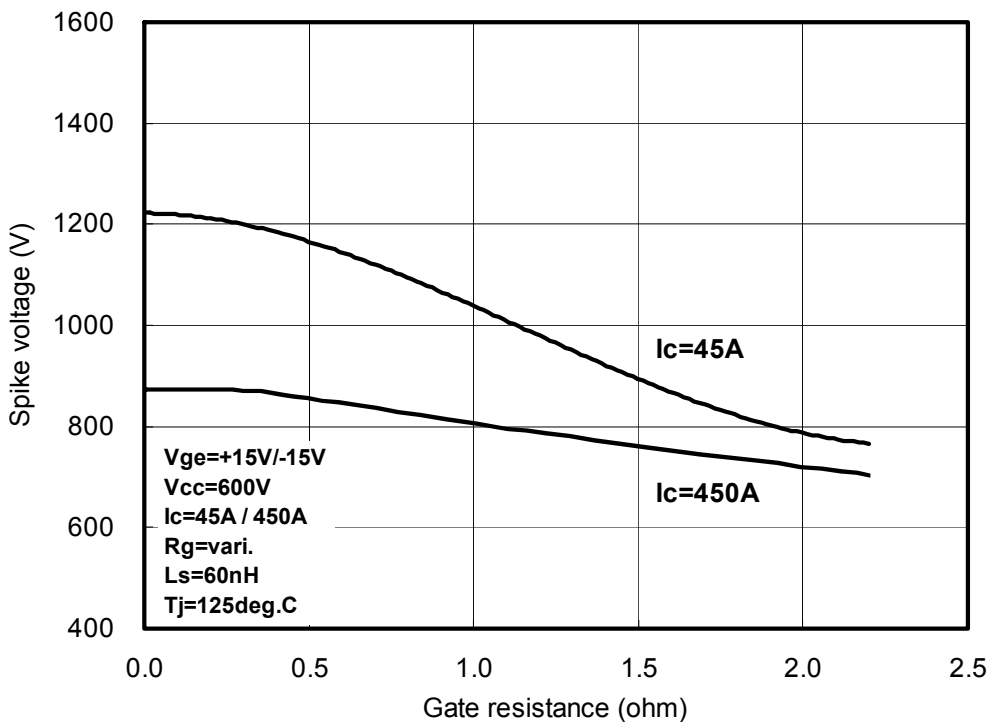

Fig. 2-5 Example of Gate Resistance Dependence of Reverse Recovery Surge Current

3.2 Gate resistance dependence of surge current at turn off (review done in another file)

In relation to overvoltage protection, Figure 2-6 shows the gate resistance dependence of 1200V V-series IGBT module.

The method of increasing the gate resistance has been used commonly to reduce the surge voltage. However, injection efficiency of IGBT chips of latest trench technology has been improved in relation to the development of new generation IGBTs and so the dependence of surge voltage on R_g is changing (See the following referenced document for details.)

Therefore, when gate resistance R_g is made higher, the result may be different from the conventional trend and in some cases the surge voltage may even become higher. Accordingly, when you select gate resistance, use the actual machine, for which the IGBT module is used, and carefully check the surge voltage.

Referenced document

- 1) Y. Onozawa et al., "Investigation of carrier streaming effect for the low spike fast IGBT turn-off", Proc. ISPSD, pp173-176, 2006.

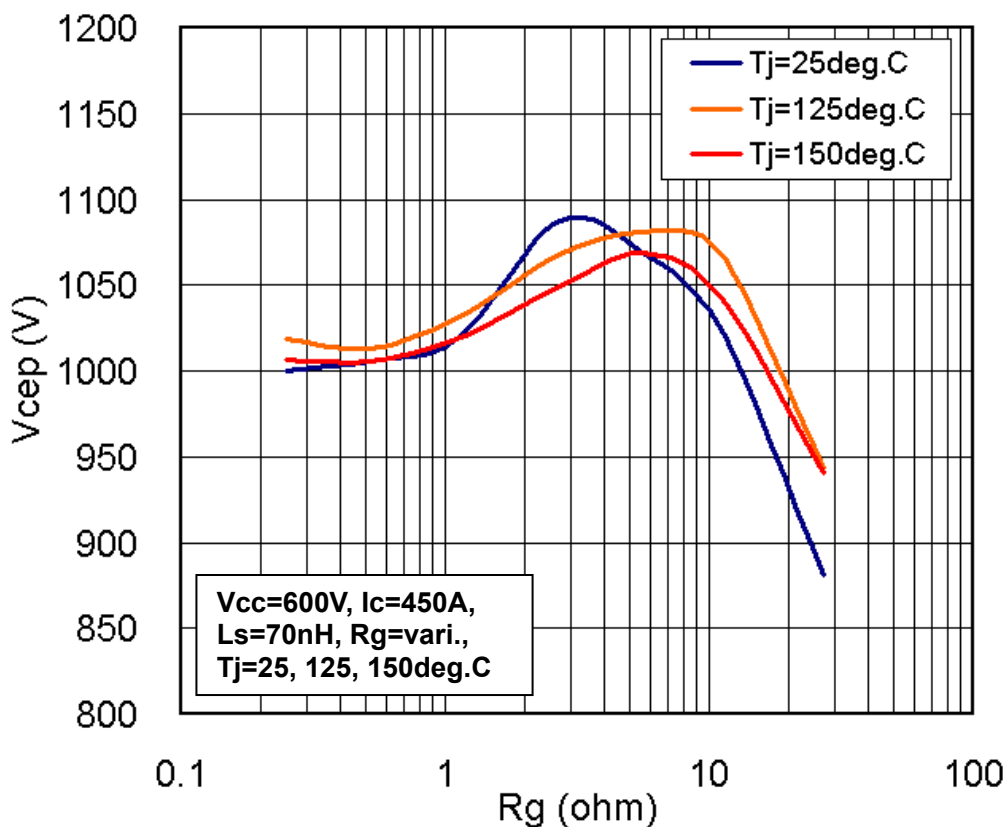

Fig. 2-6 Gate-Resistance Dependence of Turn-Off Surge Voltage (1200 Family)

3.3 Overvoltage protection when short-circuit current is cut off(review done in another file)

If IGBT is short-circuited, the collector voltage of IGBT is suddenly increased. Therefore, when current is cut off at short circuit, power supply is turned off while high energy, which is not applied during normal operation, is applied. Accordingly, the short circuit safe operation area (SCSOA) for short-circuit current cut off is set for usual RBSOA.

Figure 2-7 shows SCSOA and RBSOA for V series (1200V). For turnoff operation at short-circuit cut off, keep the operational trajectory of $V_{CE} - I_C$ within SCSOA. Note that RBSOA is defined repeatedly while SCSOA is not repetitive.

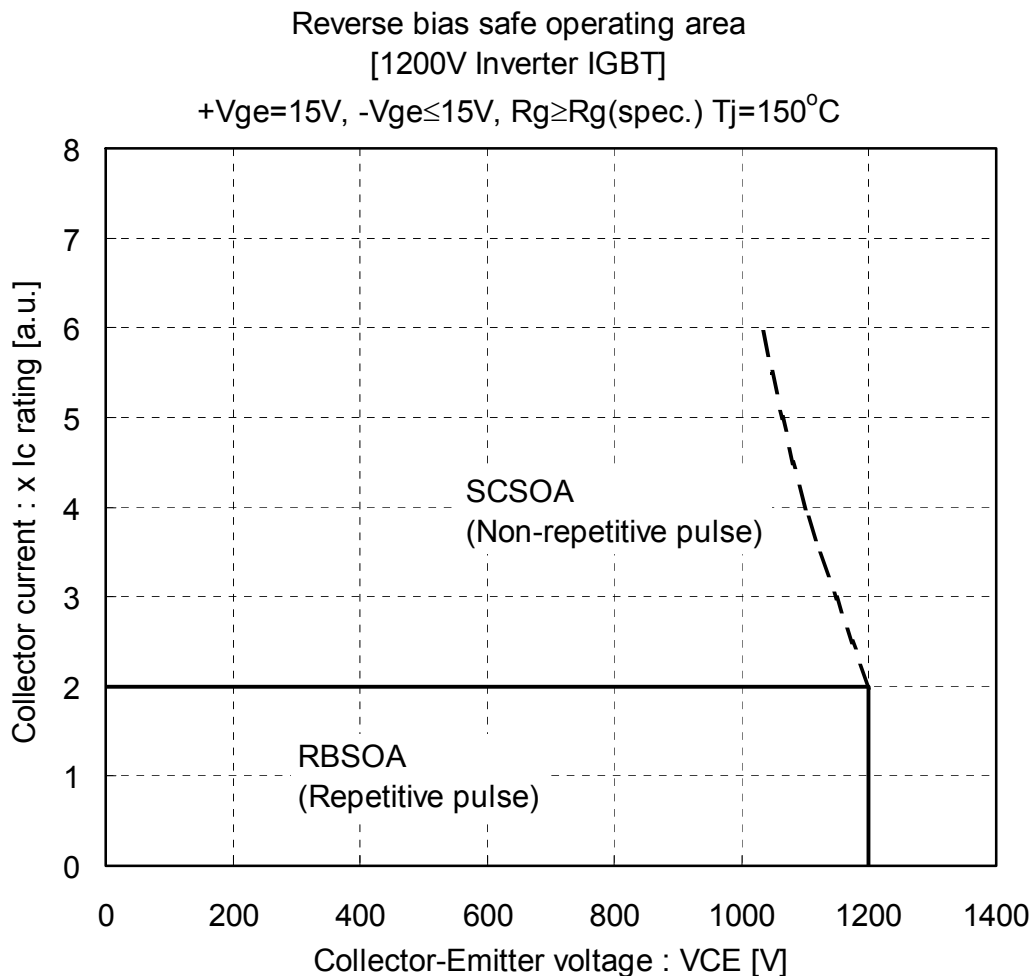

Fig. 2-7 RBSOA and SCSOA (1200V Family)

3.4 Safe operation area (SOA) for FWD

Similar to the reverse bias safe operating area (RBSOA) for IGBT, there is SOA for FWD. SOA for diode is indicated as area, in which the maximum power (P_{max}) that is the product of voltage and current applied during reverse recovery is allowed. In design, therefore, the trajectory of current and voltage (I-V trajectory) during FWD reverse recovery must be within SOA.

Figure 2-8 shows one example of SOA for FWD in 1200V product family. P_{max} in this figure is 1kW/A and is standardized in the current rating. Therefore, P_{max} for 100A rating is equivalent to 100kW.

Figure 2-9 shows one example of reverse recovery waveforms. In Figure 2-10, SOA for FWD is shown in red line and the I-V trajectory of the reverse recovery waveform in Figure 2-9 is shown in blue line. In this example, the I-V trajectory is within SOA for FWD and so there is no problem. However, the I-V trajectory shown in black line in the same figure is not within SOA and so gate resistance of the IGBT on-side must be made higher or other corrective action must be taken. The SOA voltage becomes the main terminal voltage unless otherwise specified.

As shown above, decide the gate drive conditions and others properly so that the FWD I-V trajectory is kept within SOA in all the operating conditions of the devices, for which respective IGBT modules are used.

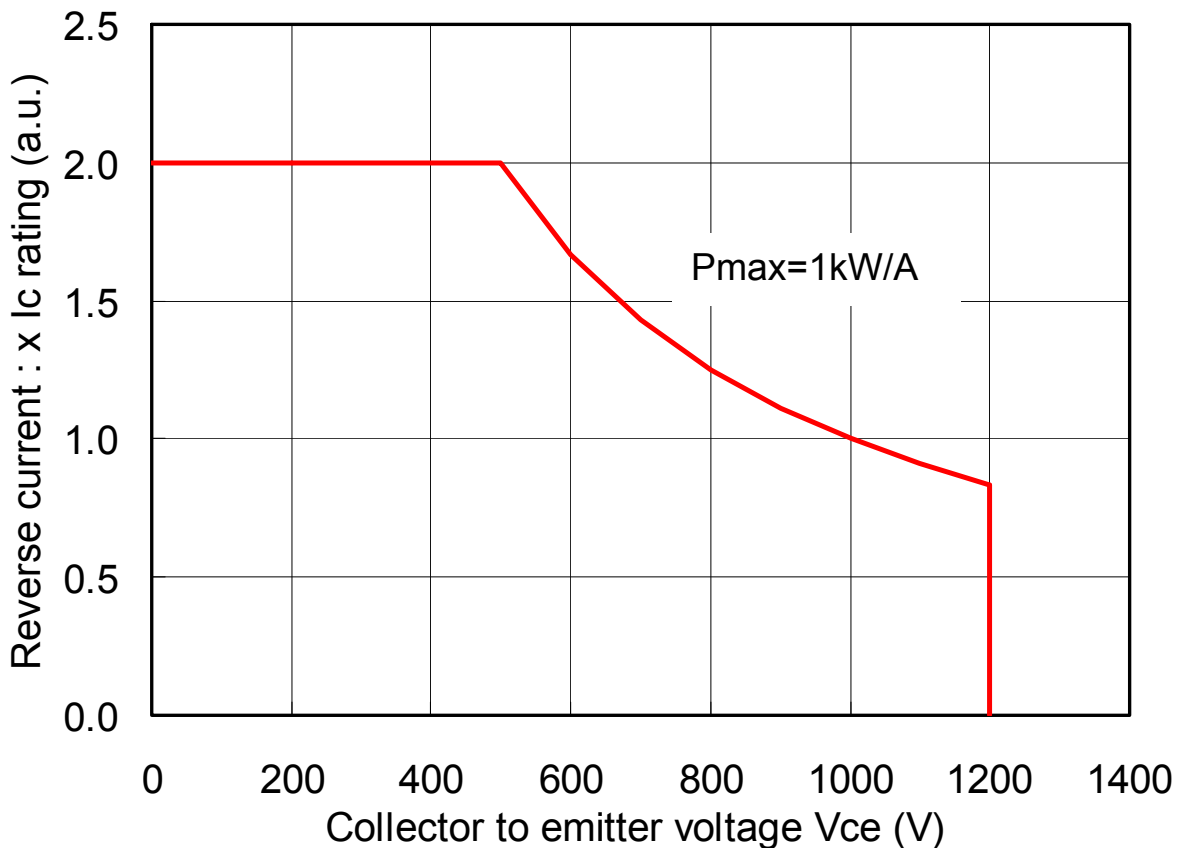

Fig. 2-8 Example of Safe Operation Area for FWD (1200V Family)

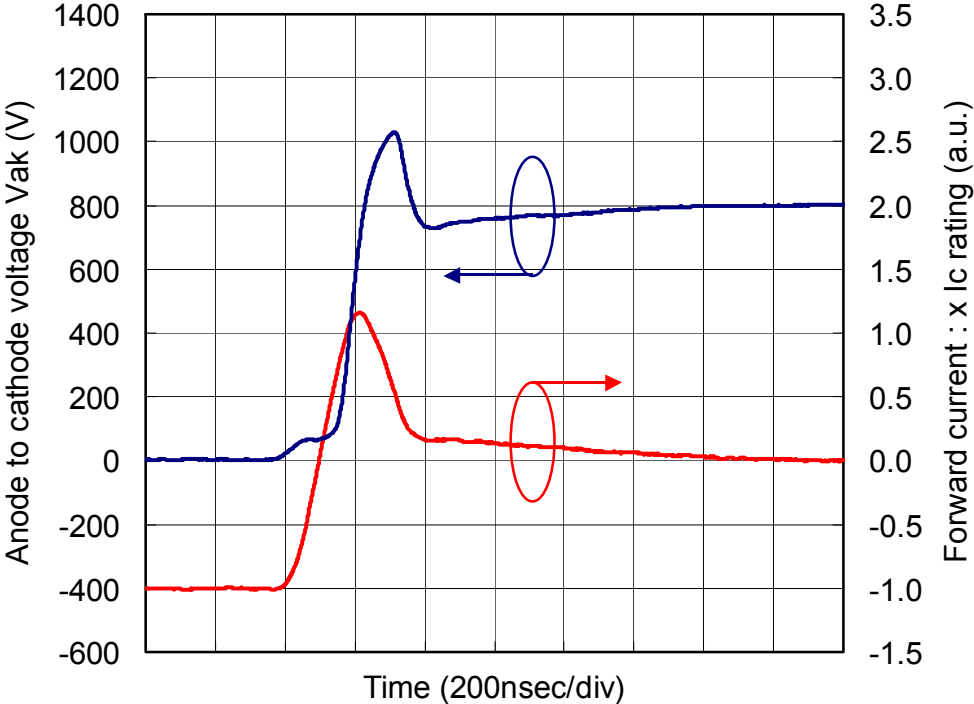

Fig. 2-9 Example of Reverse Recovery Waveform

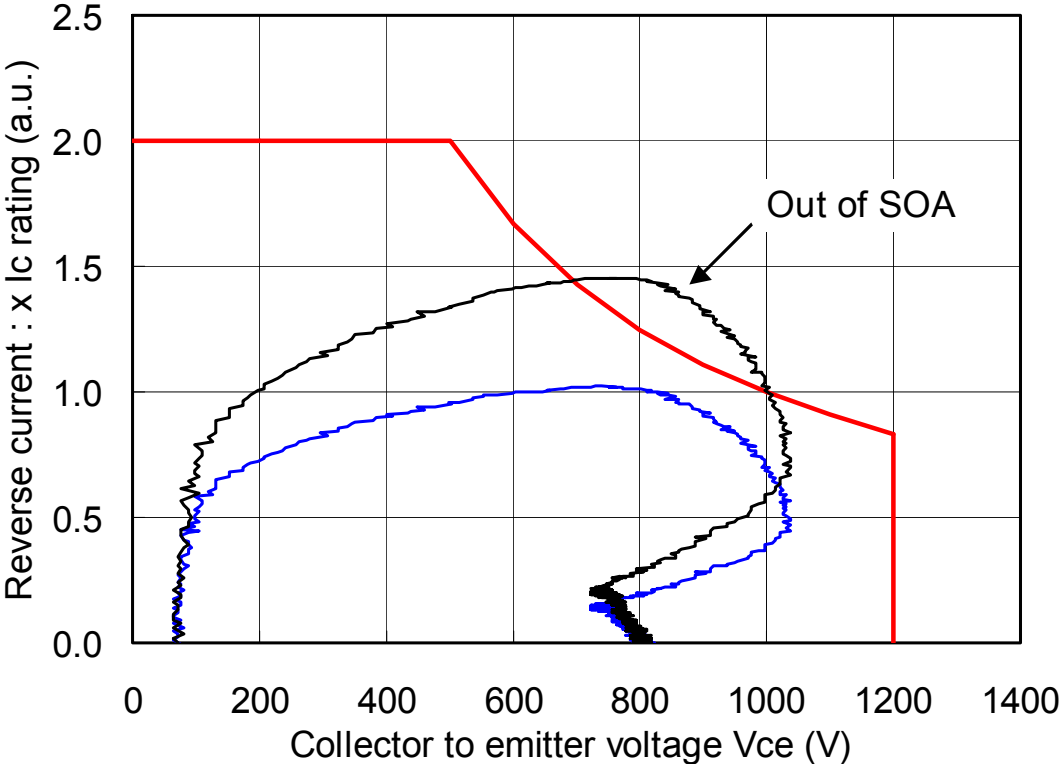

Fig. 2-10 I-V Trajectory and SOA

4 Drive conditions and dead time setting

Since the main characteristics of IGBT changes depending on drive conditions such as V_{GE} and R_G , setting must be made according to the design objective of the equipment. Gate bias conditions and dead time setting are described in this section.

1.1 Gate forward bias voltage: $+V_{GE}$ (ON-period)

The recommended value for the gate forward bias voltage $+V_{GE}$ is +15V. Precautions for design of $+V_{GE}$ are as follows.

- (1) In design, keep $+V_{GE}$ within the maximum rated voltage of 20V between G-E.
- (2) It is advised to keep fluctuation of power supply within $\pm 10\%$.
- (3) The saturation voltage between C-E ($V_{CE(sat)}$) during ON period changes depending on V_{GE} . The higher $+V_{GE}$ is, the lower it becomes.
- (4) The higher $+V_{GE}$ is, the smaller (shorter) the time and loss become at turn-on switching.
- (5) When $+V_{GE}$ is higher, surge voltage of the opposite arm is more likely to be generated at turn-on (at FWD reverse recovery).
- (6) Even if IGBT is in off period, it may malfunction due to dv/dt at FWD reverse recovery and pulsing short-circuit current may flow. Resultantly, excessive heat may be generated and IGBT may be destroyed. This phenomenon is called dv/dt false firing, and when $+V_{GE}$ is higher, it is more likely to occur.
- (7) Generally the higher $+V_{GE}$ is, the higher the limited current value becomes.
- (8) The higher $+V_{GE}$ is, the lower the short-circuit capacity becomes.

4.1 Gate reverse bias voltage: $-V_{GE}$ (off period)

The recommend value for gate reverse bias voltage $-V_{GE}$ is -5V to -15V. Precautions for design of $-V_{GE}$ are as follows.

- (1) In design, keep $-V_{GE}$ within the maximum rated voltage of 20V between G-E.
- (2) It is advised to keep fluctuation of power supply within $\pm 10\%$.
- (3) The turnoff characteristics depend on $-V_{GE}$, and especially the characteristics of section where the collector current begins to turn off depend heavily on $-V_{GE}$. Therefore, the larger $-V_{GE}$ is, the smaller (shorter) the time and loss become at turnoff switching.
- (4) dv/dt false firing may occur when $-V_{GE}$ is small, and so set it to be -5V or more. Be careful especially when the wiring of gate is long.

4.2 To avoid dv/dt false firing

Figure 3-1 shows the cause of dv/dt false firing. In this figure, it is assumed that transition is made from the off-state to the on-state on the IGBT1 side and that IGBT2 is reverse biased.

When IGBT1 is switched from the off-state to the on-state, FWD of the opposite arm, namely FWD2 is reverse recovered. At the same time, the potential of FWD2 and IGBT2 in the off-state increases and so dv/dt is generated according to the switching time of IGBT1.

IGBT1 and 2 have the feedback capacity C_{res} , respectively, and so current $I=C_{res} \times dv/dt$ is generated through this C_{res} . This current increases the gate potential through gate resistance R_g and resultantly voltage V_{ge} is generated between the gate and the emitter. If this V_{ge} exceeds the sum of IGBT2's reverse bias voltage and threshold voltage $V_{ge(th)}$, IGBT2 is false fired (on). Then IGBT1 and IGBT2 are short-circuited.

To avoid such false firing, set IGBT's reverse bias to be at least $-5V$. For setting of reverse bias, use the actual machine to check the conditions correctly.

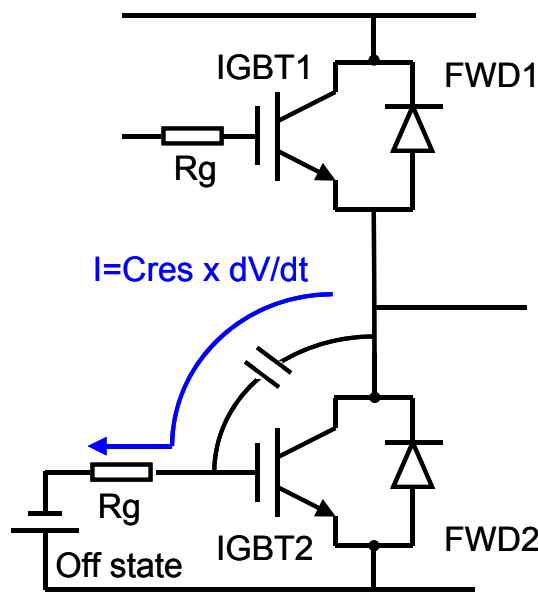

Fig. 3-1 Principle of false firing when dv/dt is generated

4.3 Setting of dead time

In an inverter circuit, dead time must be set for on-off switching timing to prevent short circuit between the upper and lower arms. As shown in Figure 3-2, both upper and lower arms are in the "off" state during the dead time. Basically the dead time must be set to be longer than IGBT's switching time ($t_{off\ max.}$).

For example, if R_g is made larger, the switching time becomes longer and so the dead time must be also made longer. In addition, it is necessary to consider other drive conditions and temperature characteristics. For the above reasons, the recommended dead time for the IGBT module is 3usec or more. However, use the actual equipment and carefully check the conditions to set the dead time.

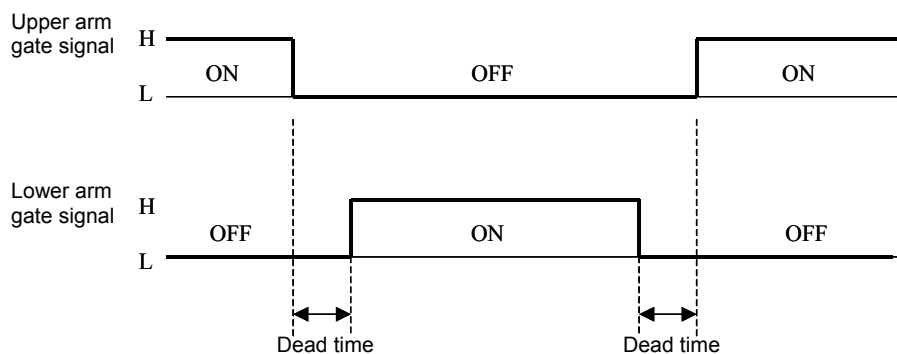

Fig. 7-5 Dead Time Timing Chart

5 Parallel connection

When IGBT modules are used in a conversion circuit, they are often connected in parallel to handle larger output current. This section describes the precautions for parallel connection of the V-series IGBT modules.

5.1 Junction temperature dependence of output characteristics and current imbalance

Junction temperature dependence of output characteristics influences the current imbalance significantly. Typical output characteristics of V series are shown in Figure 4-1. The figure shows the positive temperature coefficient in I-V characteristics, namely, when T_j becomes higher, V_{ce} becomes higher in V-IGBT. When the junction temperature dependence of IGBT's output characteristics is positive, the collector current decreases as the junction temperature increases and so the current imbalance is automatically improved.

As shown, since the output characteristics of V-IGBTs have the positive junction temperature dependence, they are suited for parallel operation. This feature that the output characteristics have the positive temperature coefficient was adopted first by the fourth-generation S series and has been succeeded by the following generations of IGBTs including V series.

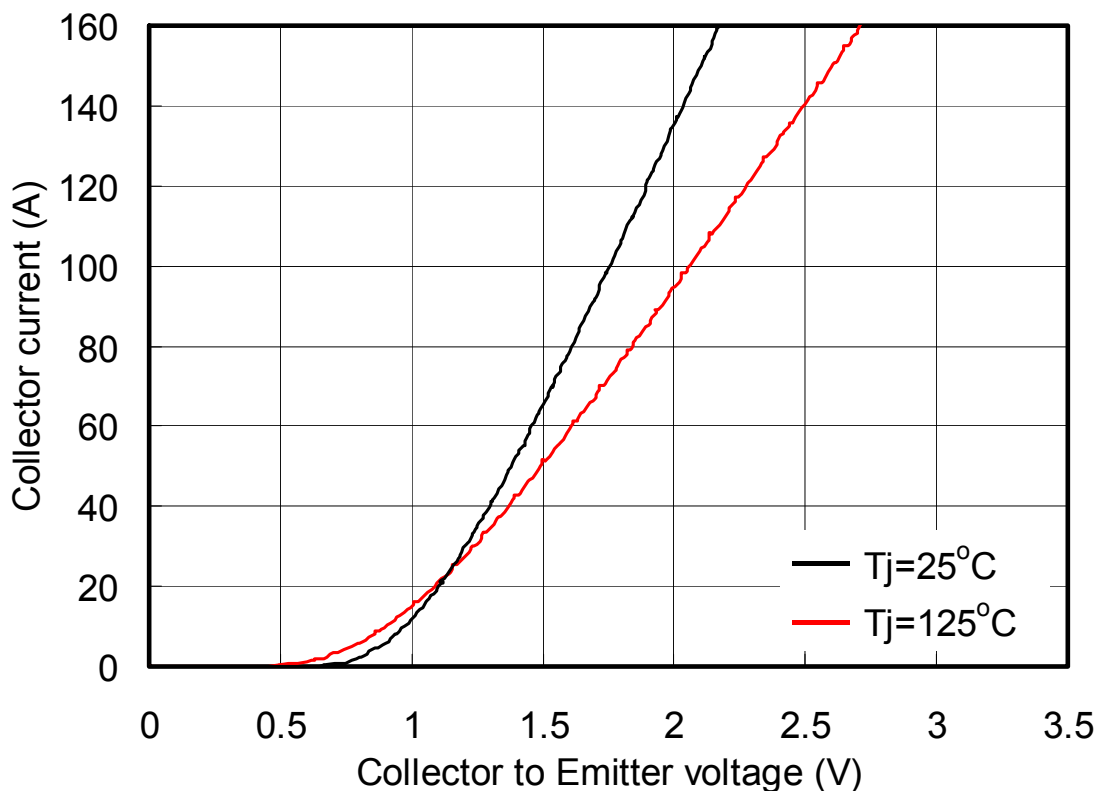

Fig. 4-1 Comparison of Output Characteristics (100A/1200V)

5.2 Variability of $V_{CE(sat)}$ and current unbalance ratio

The ratio of current sharing, which occurs at parallel connection of IGBTs, is called current imbalance ratio and decided by the temperature dependence of IGBT $V_{CE(sat)}$ and its deviation based on process variation.

Figure 4-2 shows the relation between the difference in the $V_{CE(sat)}$ and the current imbalance ratio at two-parallel connection of V-series IGBTs. The current imbalance ratio can be obtained from the value I_{C1} of current that flows on the low on-voltage side at two-parallel connection and average current value $I_{C(ave)}$.

As shown by the figure, when the difference in $V_{CE(sat)}$ is larger, the current imbalance ratio becomes larger. Therefore, for parallel connection, it is important to manage products that have small difference of $V_{CE(sat)}$ ($\Delta V_{CE(sat)}$).

$\Delta V_{CE(sat)}$ can be minimized by installing the IGBT modules of the same production lot. By doing so, the influences caused by various process factors can be minimized. Therefore, it is advised to use the modules of the same production lot when you perform parallel connection.

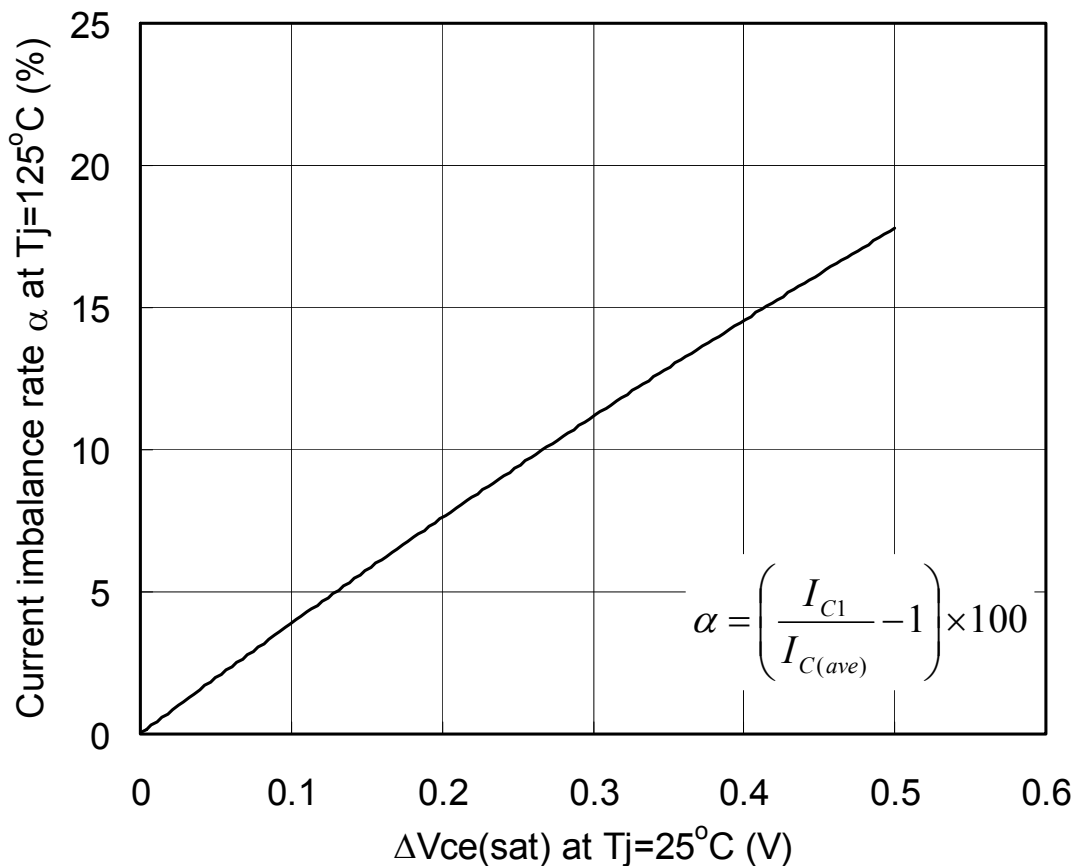

Fig. 4-2 Variability of $V_{CE(sat)}$ and Current Unbalance Ratio (1200V Family)

6 Downsizing of package

The size of package is made further smaller in the sixth-generation “V series” commercialized this time. Therefore, inverter devices can be downsized further compared with the conventional models.

On the other hand, in relation to the downsized package, in the IGBT module, in which main current is flowed through the main terminal pins, if the printed circuit board used for the module is not a proper one, the temperature of the main terminal pins may increase and exceed the heatproof temperature of the printed circuit board. Therefore, use a proper printed circuit board having the sufficient heatproof temperature so that it can withstand the temperature of the main terminal pins.

In addition, the downsized package increases the heat density, and the increase of ΔT_j may become a issue. Therefore, perform sufficient thermal evaluation with the actual equipment and make sure that the power cycle life matches to the system criteria.

The history of downsizing in the 6in1 and 2in1 packages is shown in Figures 5-1 and 5-2. The figures clearly show that the V-series IGBT modules are downsized further compared with the conventional modules. See the selection guide for the lineup of products.

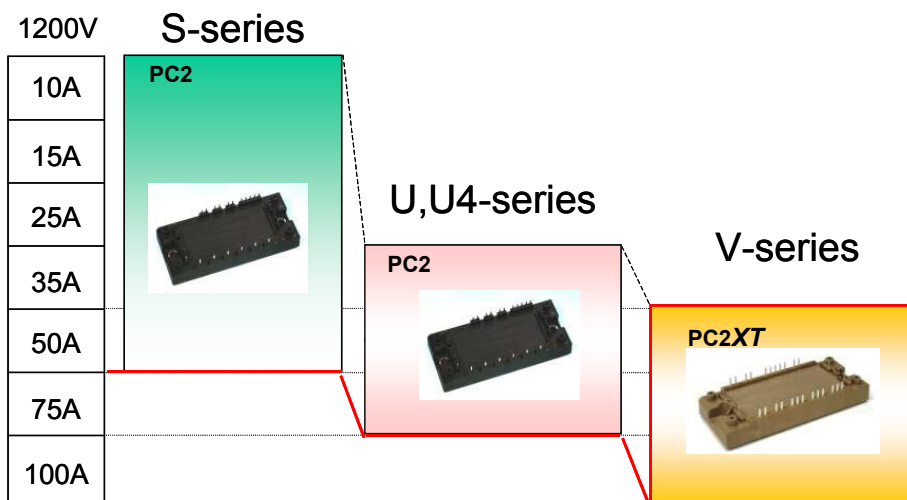

Fig. 5-1 6in1(107 x 45 x 17mm) Package

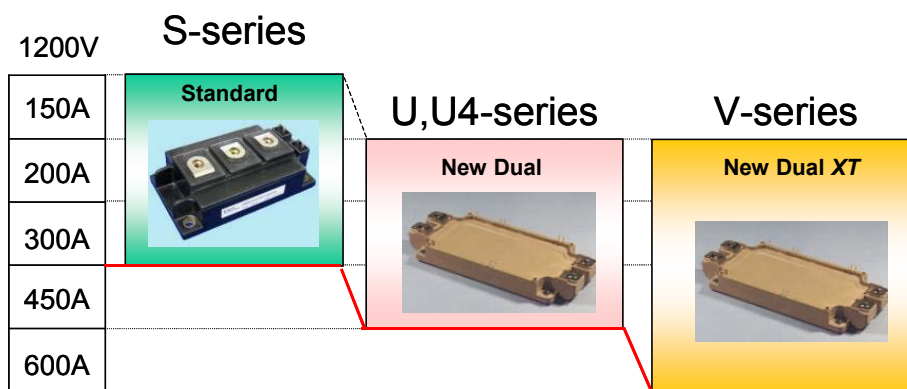

Fig. 5-2 2in1(108 x 62 x 30mm / 122 x 62 x 17mm) Package

7 Series of solder-free mounting modules

Figure 6-1 shows the appearance of spring contact module, in which coil springs are used for the control terminals, and Figure 6-2 shows the appearance of press-fit module having the press-fit main and control terminals that look like folk shape. These modules enable solder-free assembly of a control printed circuit board that operates an inverter circuit for example. They also enable mounting of a control printed circuit board with only screws and simplify the assembly process.

In response to the demand for solder less assembly, Fuji Electric strives to develop not only modules having screw and pin terminals but also various solder-free mounting modules that enable solder less assembly.



Fig. 6-1 Spring contact module

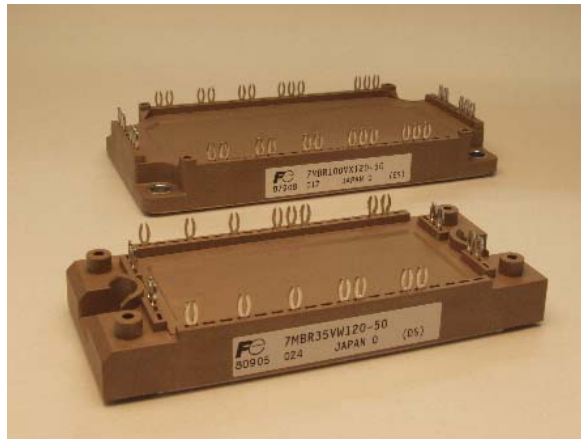

Fig. 6-2 Appearance of press-fit module

8 Mounting instructions

See the mounting instructions described separately for mounting of the V-series module package.

WARNING

1. This Catalog contains the product specifications, characteristics, data, materials, and structures as of May 2011.
The contents are subject to change without notice for specification changes or other reasons. When using a product listed in this Catalog, be sure to obtain the latest specifications.
2. All applications described in this Catalog exemplify the use of Fuji's products for your reference only. No right or license, either express or implied, under any patent, copyright, trade secret or other intellectual property right owned by Fuji Electric Co., Ltd. is (or shall be deemed) granted. Fuji Electric Co., Ltd. makes no representation or warranty, whether express or implied, relating to the infringement or alleged infringement of other's intellectual property rights which may arise from the use of the applications described herein.
3. Although Fuji Electric Co., Ltd. is enhancing product quality and reliability, a small percentage of semiconductor products may become faulty. When using Fuji Electric semiconductor products in your equipment, you are requested to take adequate safety measures to prevent the equipment from causing a physical injury, fire, or other problem if any of the products become faulty. It is recommended to make your design failsafe, flame retardant, and free of malfunction.
4. The products introduced in this Catalog are intended for use in the following electronic and electrical equipment which has normal reliability requirements.
 - Computers
 - OA equipment
 - Communications equipment (terminal devices)
 - Measurement equipment
 - Machine tools
 - Audiovisual equipment
 - Electrical home appliances
 - Personal equipment
 - Industrial robots etc.
5. If you need to use a product in this Catalog for equipment requiring higher reliability than normal, such as for the equipment listed below, it is imperative to contact Fuji Electric Co., Ltd. to obtain prior approval. When using these products for such equipment, take adequate measures such as a backup system to prevent the equipment from malfunctioning even if a Fuji's product incorporated in the equipment becomes faulty.
 - Transportation equipment (mounted on cars and ships)
 - Trunk communications equipment
 - Traffic-signal control equipment
 - Gas leakage detectors with an auto-shut-off feature
 - Emergency equipment for responding to disasters and anti-burglary devices
 - Safety devices
 - Medical equipment
6. Do not use products in this Catalog for the equipment requiring strict reliability such as the following and equivalents to strategic equipment (without limitation).
 - Space equipment
 - Aeronautic equipment
 - Nuclear control equipment
 - Submarine repeater equipment
7. Copyright ©1996-2011 by Fuji Electric Co., Ltd. All rights reserved.
No part of this Catalog may be reproduced in any form or by any means without the express permission of Fuji Electric Co., Ltd.
8. If you have any question about any portion in this Catalog, ask Fuji Electric Co., Ltd. or its sales agents before using the product. Neither Fuji Electric Co., Ltd. nor its agents shall be liable for any injury caused by any use of the products not in accordance with instructions set forth herein.