

Mounting Instruction for
Fuji Automotive IGBT Module
M653 Series
6MBI800XV-075V-01

Mounting Instruction

Warning:

This manual contains the product specifications, characteristics, data, materials, and structures as of August 2019.

The contents are subject to change without notice for specification changes or other reasons. When using a product listed in this manual, be sure to obtain the latest specifications.

All applications described in this manual exemplify the use of Fuji's products for your reference only. No right or license, either express or implied, under any patent, copyright, trade secret or other intellectual property right owned by Fuji Electric Co., Ltd. is (or shall be deemed) granted. Fuji Electric Co., Ltd. makes no representation or warranty, whether express or implied, relating to the infringement or alleged infringement of other's intellectual property rights which may arise from the use of the applications described herein.

Cautions

(1) During transportation and storage

Keep locating the shipping carton boxes to suitable side up. Otherwise, unexpected stress might affect to the boxes. For example, bend the terminal pins, deform the inner resin case, and so on.

When you throw or drop the product, it gives the product damage.

If the product is wet with water, that it may be broken or malfunctions, please subjected to sufficient measures to rain or condensation.

Temperature and humidity of an environment during transportation are described in the specification sheet. There conditions shall be kept under the specification.

(2) Assembly environment

Since this power module device is very weak against electro static discharge, the ESD countermeasure in the assembly environment shall be suitable within the specification described in specification sheet. Especially, when the conducting pad is removed from control pins, the product is most likely to get electrical damage.

(3) Operating environment

If the product had been used in the environment with acid, organic matter, and corrosive gas (hydrogen sulfide, sulfurous acid gas), the product's performance and appearance can not be ensured easily.

CONTENTS

1. Scope of Application	1
2. Mounting Sequence	1
3. PCB Reference Specification	1
4. Attaching the PCB to the IGBT Module	3
5. Flange Adaptor	5
6. Mounting of IGBT Module to Equipment	8
7. Connecting to the Main Terminals	10
8. Storage and Transport	11
9. IGBT Module Appearance	11

1. Scope of Application

This manual explains how to mount and use the M653 packaging products safely.
This mounting instruction is available only for the following modules.

•6MBI800XV-075V-01

In handling this IGBT module, strictly observe the contents described in "Warnings" and "Caution" of the specification sheet in addition to the contents described in this manual.

2. Mounting Sequence

For reference, the mounting sequence of the IGBT module and PCB is shown below.

- (1) Align the PCB with the IGBT module and mount it (Two guide pins will support this process).
- (2) Fix the PCB on the IGBT module by screws.
- (3) Solder the PCB holes and control terminals.
- (4) Fasten the IGBT modules to the equipment with screws.
- (5) Connect the main terminals of the IGBT module to busbar, capacitor, etc.

3. PCB Reference Specification

Since the PCB tolerances depend on the PCB manufacturing process and are produced with the dimensions unique to the customer, typical PCB sizes and tolerances cannot be recommended. However, for reference, the evaluation board size and hole size of Fuji Electric are shown in Figure 1. This is a reference value, so finally confirm it sufficiently by the customer.

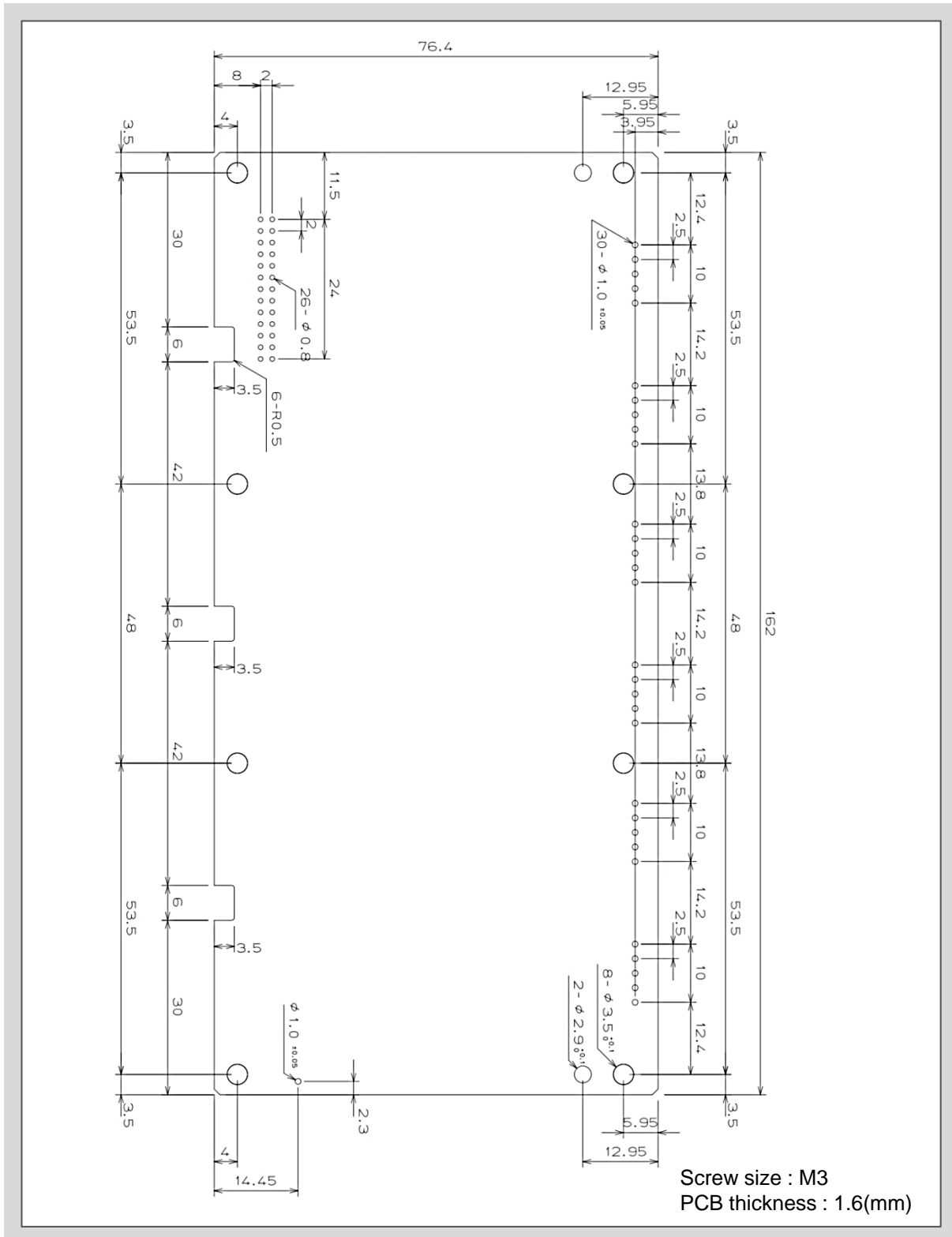

Fig. 1 Assembly drawing of the driver board (Top)

4. Attaching the PCB to the IGBT Module

4.1 Electrostatic discharge protection

If excessive static electricity is applied to the control terminal, the module may be damaged. Please take countermeasures against static electricity when handling the module.

Assembly environment relating to ESD shall be within specified value shown in the specification sheet.

When unpacking the product, it is important that there be no control pin contact when handling the product after removing the conductive foam, as this could cause electrostatic discharge damage. When installing the product in a piece of equipment, it is requested that you only remove the conductive foam just before PCB mounting in order to prevent electrostatic discharge damage. (Refer to the work flow in Figure 2)

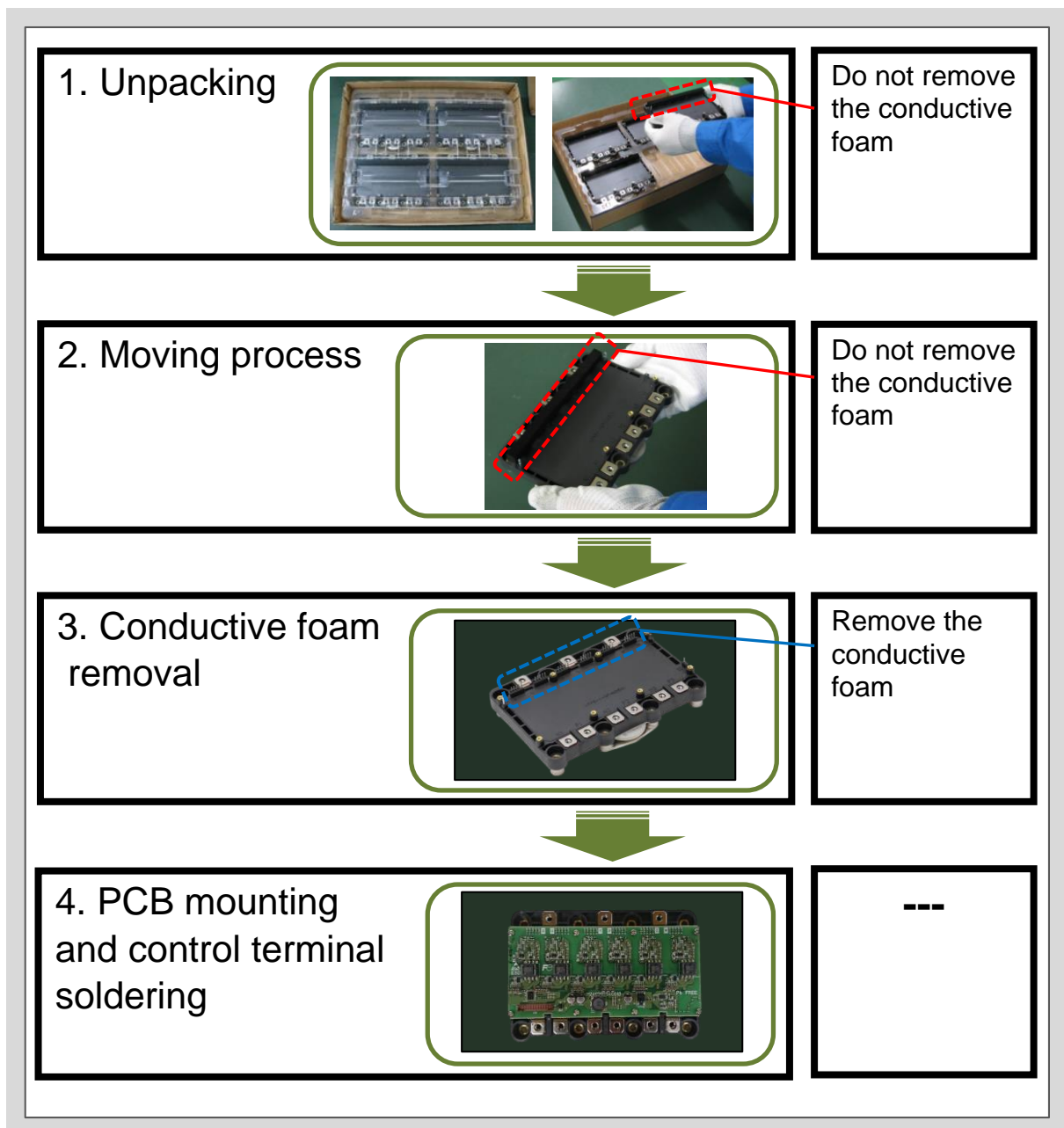

Fig. 2 Conductive foam removal procedures

4.2 Soldering of the control terminals

Soldering of the control terminals shall be performed based on the condition which is described on the specification sheet. Otherwise, disconnect between them might be happened.

4.3 Method of mounting the PCB

- (a) As screws to be used at positions (1) to (8), specified screw size and tightening torque described in the specification sheet.

The length of the screw thread for PCB can be considered by the drawings of the module in the specification sheet.

Adjust the length of the screws depending on the types of the screws used if necessary.

- (b) Fix the screws temporarily with 1/3 of the final fastening torque and in the sequence from (1) to (8) in Figure 3.

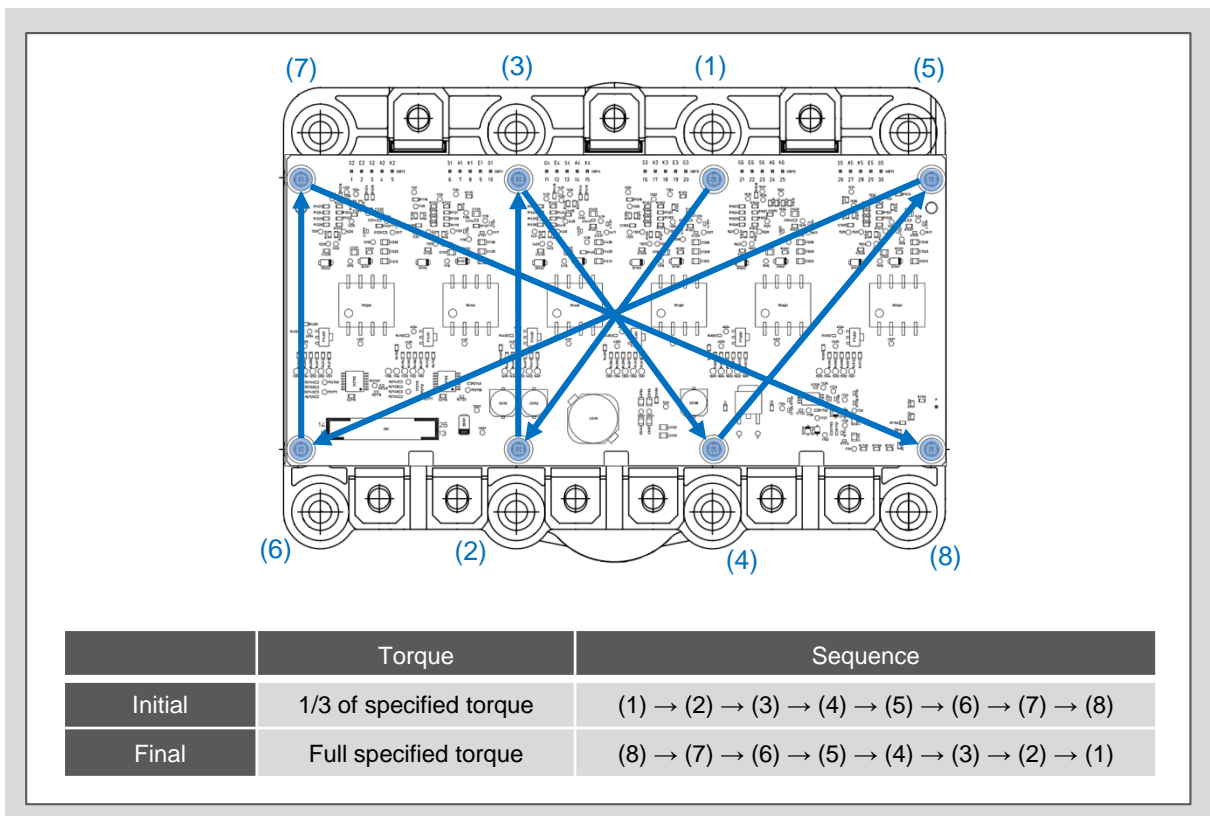

Fig. 3 Screw sequence for PCB fix

5. Flange Adaptor

5.1 Connection adapter to flange part

Since the tolerances of the adapter to be connected to the flange portion depend on the manufacturing process and are made with the dimensions specific to the customer and tolerances cannot be recommended. However, for reference, the size of the flange adapter kit of the optional component for evaluation of Fuji Electric is shown in Figure 5.

5.2 Selection of O-ring

When this IGBT is installed to a power control system, certain suitable O-ring is needed. Size and material of O-ring depend on the system design and the operational environment of the system. Therefore, when O-ring is selected, sufficient confirmation about seal performance shall be needed.

There is an example of O-ring in Table 1 as the flange adapter kit for IGBT module evaluation. Seal area of the flange for the flange adapter kit is shown in Figure 4.

5.3 Temperature check

After selecting a O-ring and determining the mounting position of the IGBT module, the temperature of each part should be measured to make sure that the junction temperature (T_{vj}) of the IGBT module does not exceed the rating or the designed value.

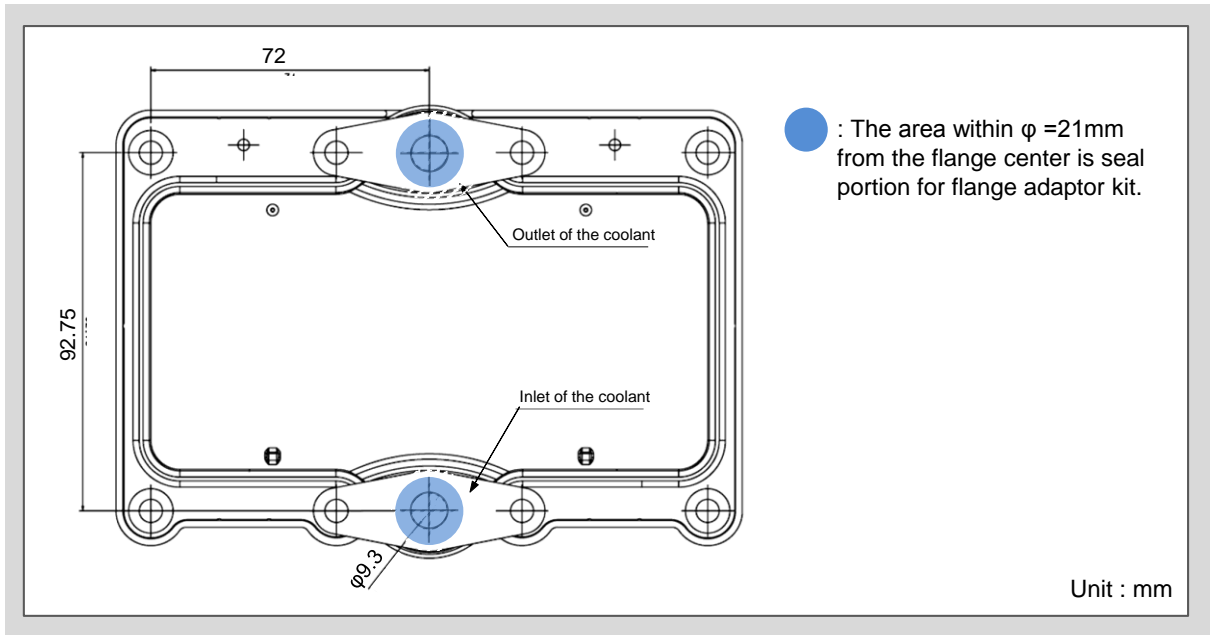

Fig. 4 Seal area of the flange

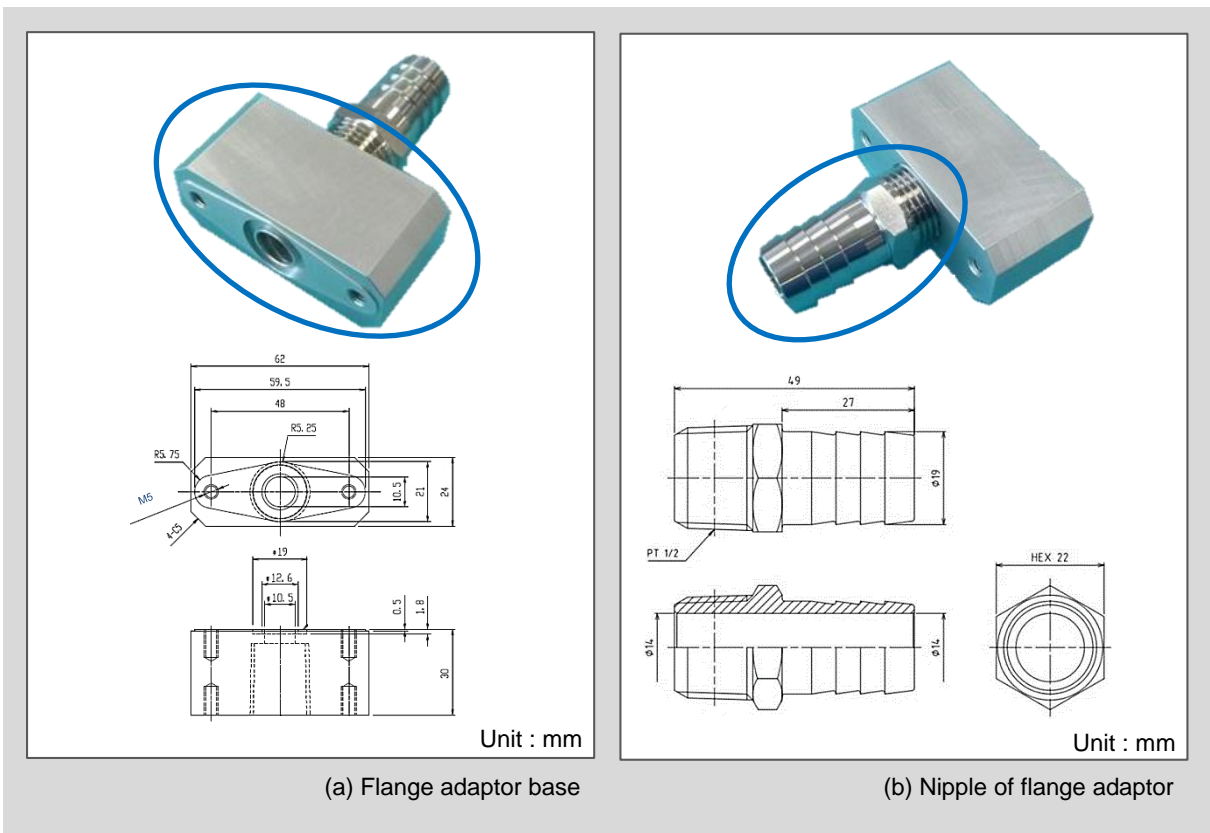

Fig. 5 Flange adaptor kit : flange adaptor base and nipple

Reference information of O-ring of the flange adaptor kit

- Size : P15 @JIS standard
- Material : NBR(Nitrile rubber)
- Hardness : 70

Table 1 Size of O-ring (Unit : mm)

Nominal size (JIS)	Dimension of O-ring			Dimension of groove												
	Thickness W	Inner dimension do		d	D	G(tolerance $\begin{smallmatrix} +0.25 \\ 0 \end{smallmatrix}$)			H	R						
						No Backup ring	One backup ring	Two backup ring			H±0.05	MAX				
P10A		9.8	±0.20	10	14											
P11		10.8	±0.21	11	15											
P11.2		11.0		11.2	15.2											
P12		11.8	±0.22	12	16											
P12.5		12.3		12.5	16.5											
P14		13.8		14	18											
P15		2.4±0.09	14.8	±0.24	15 $\begin{smallmatrix} 0 \\ -0.06 \end{smallmatrix}$						19 $\begin{smallmatrix} +0.06 \\ 0 \end{smallmatrix}$	3.2	4.4	6.0	1.8	0.4
P16		15.8		16	20											
P18		17.8	±0.25	18	22											
P20		19.8	±0.26	20	24											
P21		20.8	±0.27	21	25											
P22		21.8	±0.28	22	26											

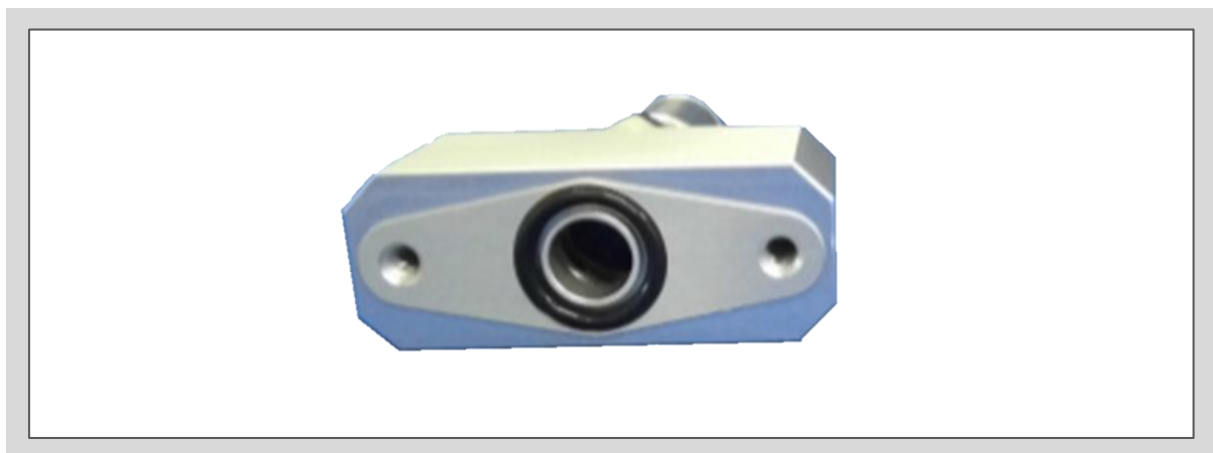

Fig. 6 The image of assembled O-ring onto the flange adaptor base

6. Mounting of IGBT Module to Equipment

6.1 Mounting direction of the IGBT module

Strictly observe the angle stated in the specification sheet for the mounting angle of the IGBT module. If mounting at an angle out of the specification range, air bubble would be remained in the cooler when cooling water is flowed. Air bubble might make cavitation phenomenon and it is cause of water leakage.

Also, since reliability under mounting conditions out of the specification has not been tested, we do not know what kind of problems will occur.

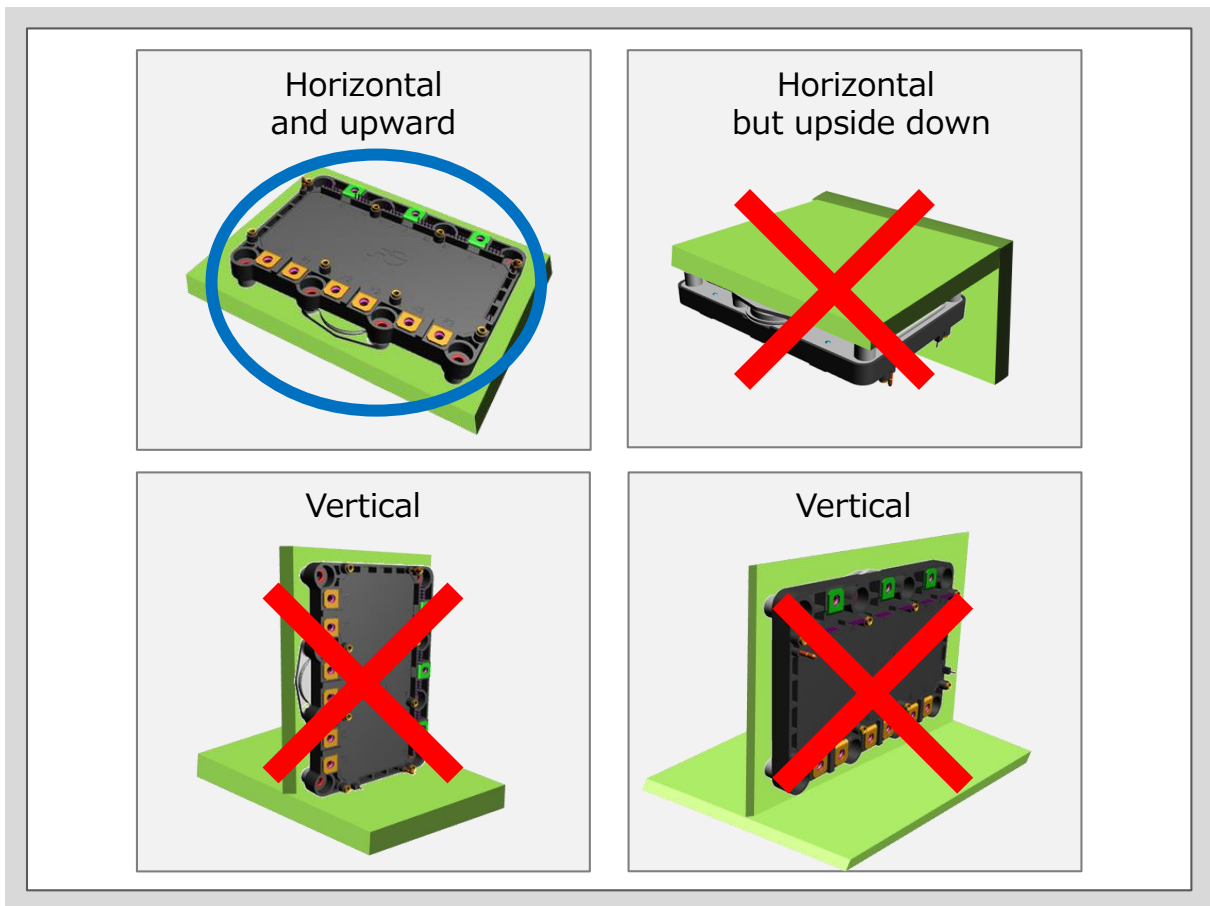

Fig. 7 IGBT module mounting direction

6.2 Method of fastening the IGBT module

Figure 8 shows the recommended procedure of tightening screws for mounting the IGBT module.

The fastening screws should be tightened with the specified torque.

See the specification for the specified torque and screws size to be used.

In addition, the use of self-tapping screws is not guaranteed.

6.3 Prohibited matters:

- (1) Excessive tightening torque: IGBT module shall not be used anymore.
Cause of cooling system destruction by deformation of the aluminum cooler and buckling of the stud.
- (2) Insufficient tightening torque:
Liquid leakage from the cooling flange may occur, or the screws may be loosened during operation, cooler destruction due to vibration during operation are expected.
- (3) Applying a load onto the cover of the cooler:
Cause of cooling system destruction, cooling water leakage are expected.

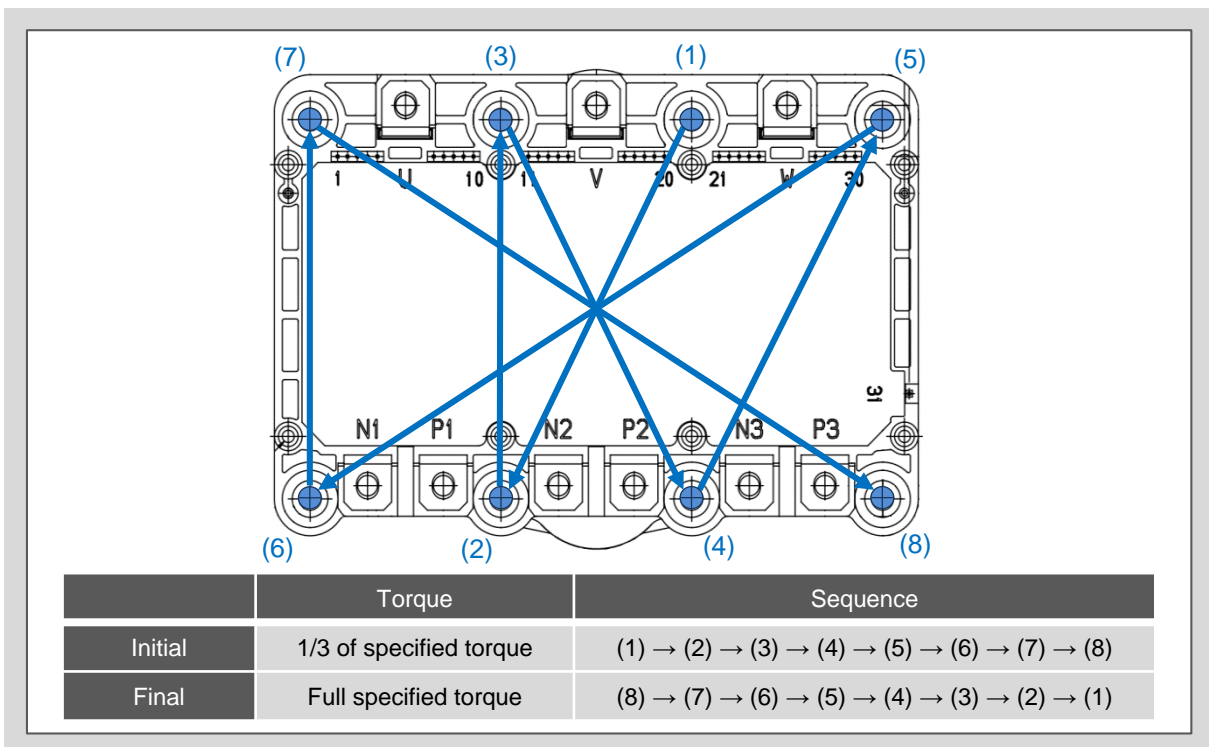

Fig. 8 Screw sequence for IGBT module

6.4 Flatness of fastening part

The flatness of the fastening portion of the module is specified in the specification. In addition, the following values are recommended for the system flatness at the module area.

System flatness at the module area : $\leq 50\mu\text{m}$

Exceeding the requirement above may lead to damage of the power module.

6.5 Parallel connections

In high capacity inverters and other equipment that needs to control large currents, it may be necessary to connect IGBT modules in parallel. When connected in parallel, it is important that the circuit design allows for an equal flow of current to each of the modules. If the current is not balanced among the IGBTs, a higher current may build up in just one device and destroy it. The electrical characteristics of the module as well as the wiring design, change the balance of the current between parallel connected IGBTs. In order to help maintain current balance it may be necessary to match the $V_{CE(sat)}$ values of all devices.

Also, when the IGBT module has the cooler with the water jacket, it is necessary to adhere strictly to specifications such as water temperature, water flow and pressure within each water jacket.

For more detailed information on parallel connections, refer to the application manual for IGBT module.

7. Connecting to the Main Terminals

7.1 Connection of the main circuit

- (1) Screw size: M5
- (2) Maximum fastening torque: refer to the specification sheet.
- (3) Length of the screw: Check the depth of screw holes on the outline drawing.
Adjust the length of the screws depending on the types of screws used if necessary.

7.2 Clearance and creepage distance

It is necessary to keep enough clearance distance and the creepage distance (defined as (a) in Figure 9) from the main terminal to secure desirable insulation voltage. The clearance distance and the creepage distance must be longer than the minimum value shown in below.

Suitable insulation distance between a bus-bar and the main terminal screw of the module shall be designed when the module is installed to a power system.

Screws for tightening a control board on the module shall be electrically isolated. And the screws shall be appropriately selected by taking account of insulation distance between the control terminals of the module and the screws.

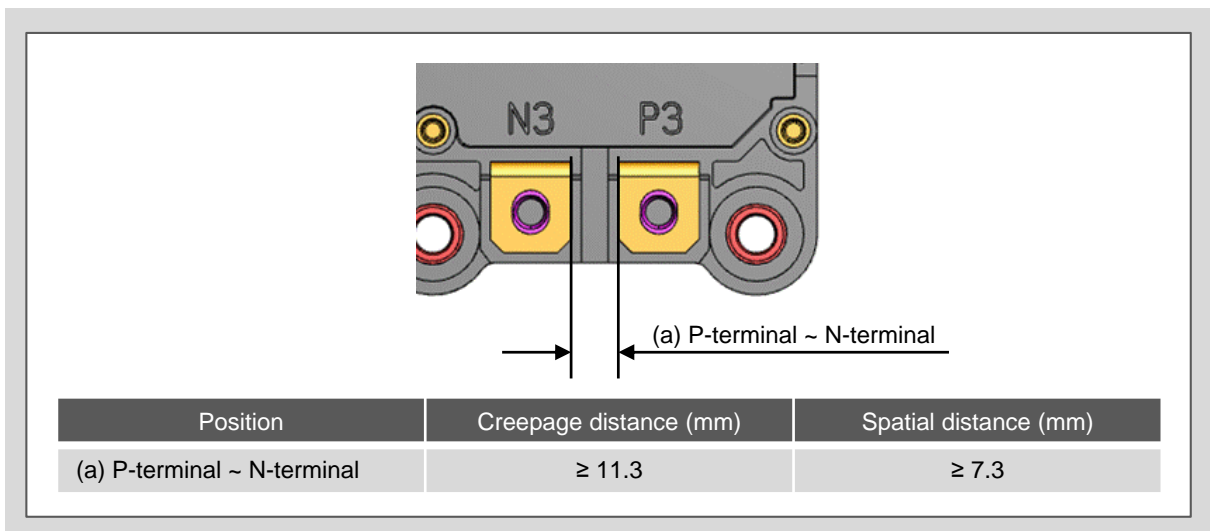

Fig. 9 Creepage distance and spatial distance at the P/N terminal

8. Storage and Transport

Refer to the "Caution" in the specification sheet for the storage and transport conditions and precautions, and strictly observe the contents.

9. IGBT Module Appearance

The following describes the contents of the appearance of this IGBT module.

9.1 Tin plating of main terminal

The main terminals are made of copper plated with tin. The tin plating provides to prevent discoloration and oxide of the main terminals of the IGBT modules. After mounting, the tin plating has finished its role, and the contact resistance is the same as that of the main terminals of pure copper that are not plated. Therefore, visible scratches before mounting, thin plated areas such as terminal edges and bending areas do not affect product performance or quality.

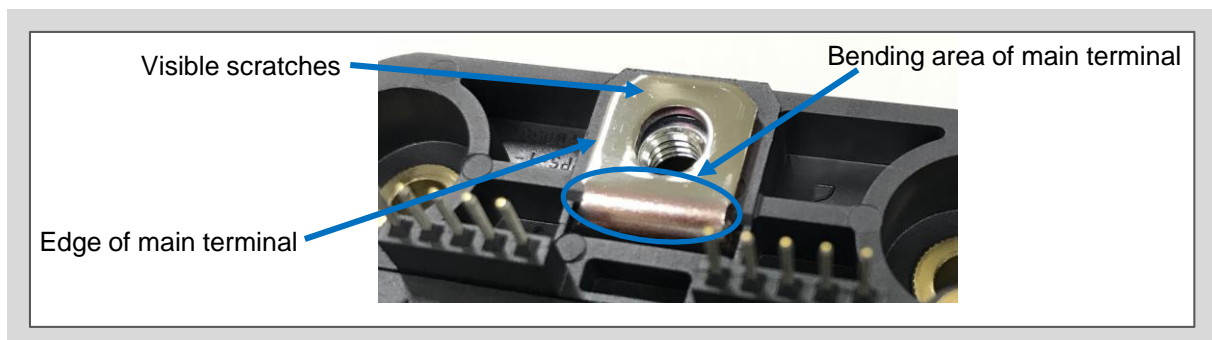

Fig. 10 Appearance of main terminal