



Instruction Manual

**FIXED TYPE ULTRASONIC
FLOWMETER (FSV-2)
(Advanced type)
COMMUNICATION
FUNCTIONS**

TYPE: FSV-2

Note: MODBUS® is the trade mark or registered trade mark of AEG Schneider Automation International.

NOTICE

1. Exemption items from responsibility

The contents of this document may be changed in the future without prior notice.

We paid the utmost care for the accuracy of the contents. However, we are not liable for direct and indirect damages resulting from incorrect descriptions, omission of information, and use of information in this document.

CONTENTS

1.	COMMUNICATION FUNCTIONS	1
1.1	General	1
2.	SPECIFICATIONS	3
2.1	Communication Specifications.....	3
3.	CONNECTION.....	4
3.1	Communication Terminal Allocation.....	4
3.2	Wiring.....	5
4.	SETTING OF COMMUNICATION CONDITION	6
4.1	Set Items	6
4.2	Setting operation method.....	6
5.	MODBUS COMMUNICATION PROTOCOL	7
5.1	General	7
5.2	Composition of Message	8
5.3	Response of Slave Station	9
5.4	Function Code	10
5.5	Calculation of Error Check Code (CRC-16)	11
5.6	Transmission Control Procedure	12
5.7	FIX Processing (Cautions in data write).....	14
6.	DETAILS OF MESSAGE.....	15
6.1	Read-out of Word Data [Function code:03 _H]	15
6.2	Read-out of Read-out Only Word Data [Function code:04 _H].....	17
6.3	Write-in of Word Data [Function code:06 _H]	19
6.4	Write-in of continuous word data [Function code:10 _H].....	20
7.	ADDRESS MAP AND DATA FORMAT	22
7.1	Data Format	22
7.2	Address Map.....	24
8.	M-FLOW COMMUNICATION PROTOCOL	38
8.1	General	38
8.2	Message Configuration.....	39
8.3	Error Check	39
8.4	Function Code Table	40
8.5	Error Code Table	40
9.	PC LOADER SOFTWARE IN CD SUPPLIED WITH THE MAIN UNIT	41
9.1	Copyright of This Software	41
9.2	Outline	41
9.3	PC to Be Used	41
9.4	Installing of Software	42
9.5	Startup Method	45
9.6	Measurement mode setting procedure.....	50
9.7	Structure of Function.....	56
9.8	System Setting	57
9.9	Process Setting	59
9.10	Range Setting	63
9.11	Total Setting	65

9.12	Status Output Setting.....	67
9.13	Display Setting.....	69
9.14	Measurement.....	71
9.15	Transit Time Difference Measurement.....	73
9.16	RAS.....	78
9.17	Maintenance.....	79
9.18	PV.....	81
9.19	End.....	83
9.20	Uninstalling of Software.....	83
10.	TROUBLESHOOTING.....	84

1. COMMUNICATION FUNCTIONS

1.1 General

- This instrument provides a communication function by RS-485 interface, by which it can transmit and receive data to and from host computer, programmable controller, graphic display panel, etc.
- When using the RS-485 interface, the communication system consists of master station and slave stations. Up to 31 slave stations (this instrument) can be connected per master station.
Note that, because the master station can communicate with only one slave station at a time, a party to communicate with must be specified by the “Station No.” set at each slave station.
- In order that the master station and slave station can communicate, the format of the transmit/receive data must coincide. With this instrument, communication data format is determined by the MODBUS protocol and M-Flow protocol (our M-flow [Type: FLR]).
- Please use an RS-232C ⇔ RS-485 converter in case of designating a personal computer or other devices which have an RS-232C interface as a master station.

[RS-232C ⇔ RS-485 converter] (recommended article)

Type: K3SC-10 (isolated type)/OMRON Corporation

System configuration (when using the RS-485 interface)

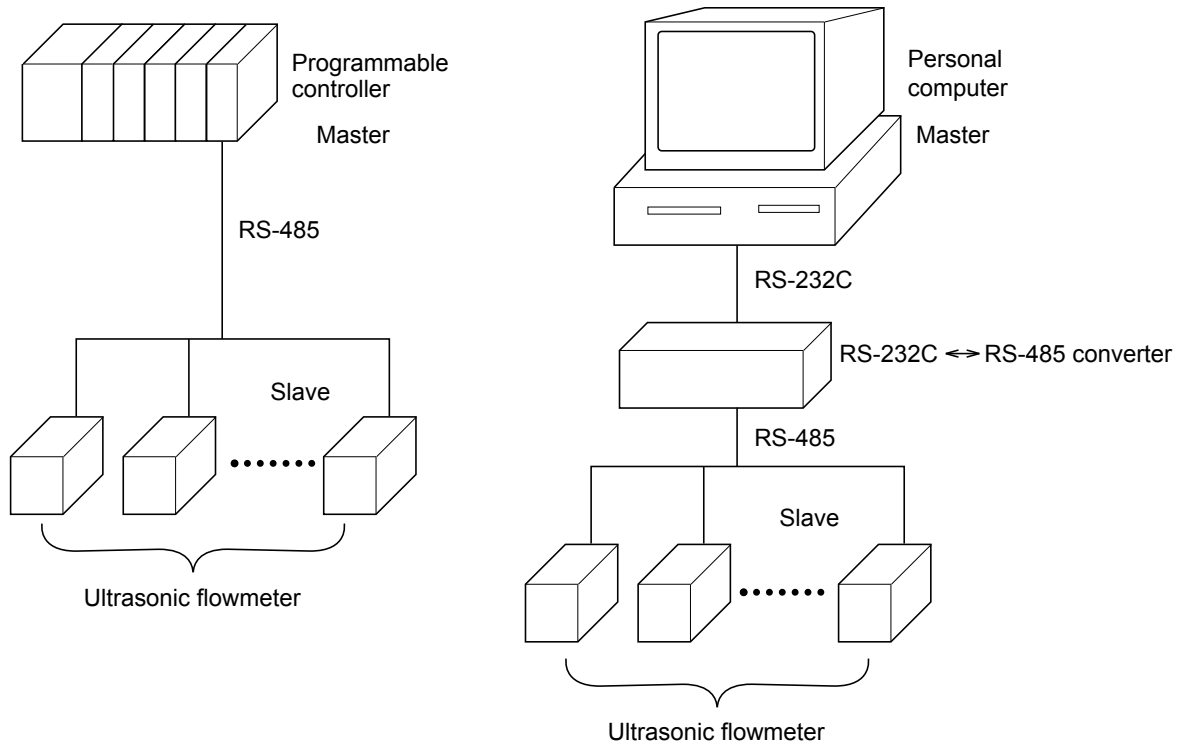

[Note] MODBUS[®] is the registered trademark of Schneider Electric.

Caution:

When using the RS-232C ↔ RS-485 converter, pay attention to cable connection between the converter and master station. If the cable is not connected correctly, the master station and slave station cannot communicate. In addition, be careful about communication settings such as baud rate and parity set for the converter.

2. SPECIFICATIONS

2.1 Communication Specifications

Item	Specification	
Electrical specification	Based on EIA RS-485	
Transmission system	2-wire, semi-duplicate	
Synchronizing system	Start-stop synchronous system	
Connection format	1 : N (RS-485)	
Number connectable units	Up to 31 units (RS-485)	
Transmission distance (total extension)	1,000 m max. (RS-485)	
Transmission speed	9600, 19200, 38400 bps	
Data format	Data length	8 bits
	Stop bit	1 bit
	Parity	none, even, odd (selectable)
Isolation	Functional isolation between transmission circuit and ground (withstand voltage : 500V AC)	

2.1.1 Communication protocol

(1) MODBUS protocol

Item	Specification
Transmission code	HEX value (MODBUS RTU mode)
Error detection	CRC-16

(2) M-Flow protocol (our M-Flow [Type: FLR])

Item	Specification
Transmission code	ASCII
Error detection	LRC (Logical redundancy check)

3. CONNECTION

⚠ WARNING

For avoiding electric shock and malfunctions, do not turn on the power supply until all wiring have been completed.

3.1 Communication Terminal Allocation

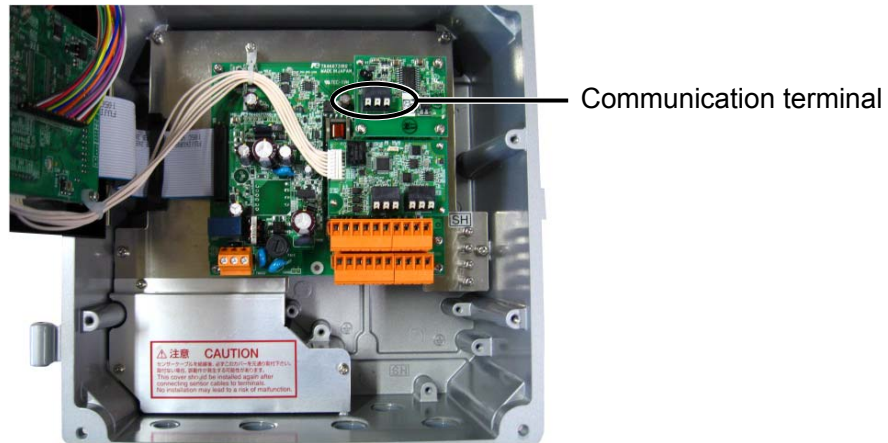

Communication Terminal

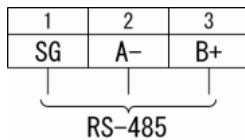

■ Useable wire material

- Electric wire
Thickness: AWG20 (0.5mm²) to AWG16 (1.5mm²)
Strip-off length: 8 to 10mm



- Bar terminal
Weidmüller
www.weidmüller.com

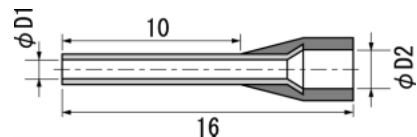

Electric wire thickness (mm ²)	φ D1 (mm)	φ D2 (mm)	Model
0.5	1	2.6	H0.5/16
0.75	1.2	2.8	H0.75/16
1	1.4	3	H1/16
1.5	1.7	3.5	H1.5/16

3.2 Wiring

3.2.1 RS-485 interface

- Use twisted pair cables with shield.
 - Recommended cable: UL2464, UL2448, etc.
- The total extension length of the cable is up to 1000 m. A master station and up to 31 units of this instrument can be connected per line.
- Terminate the both ends of the cable with 120Ω ($1/2$ W or higher) terminating resistors.
 - Note: See the specifications of the master for the terminating resistors of the master station unit.
- The shield wire of the cable should be grounded at one place on the master station unit side.
- If this instrument is to be installed where the level of noise applied to this instrument may exceed 1000 V, it is recommended to install a noise filter in the master station side as below.

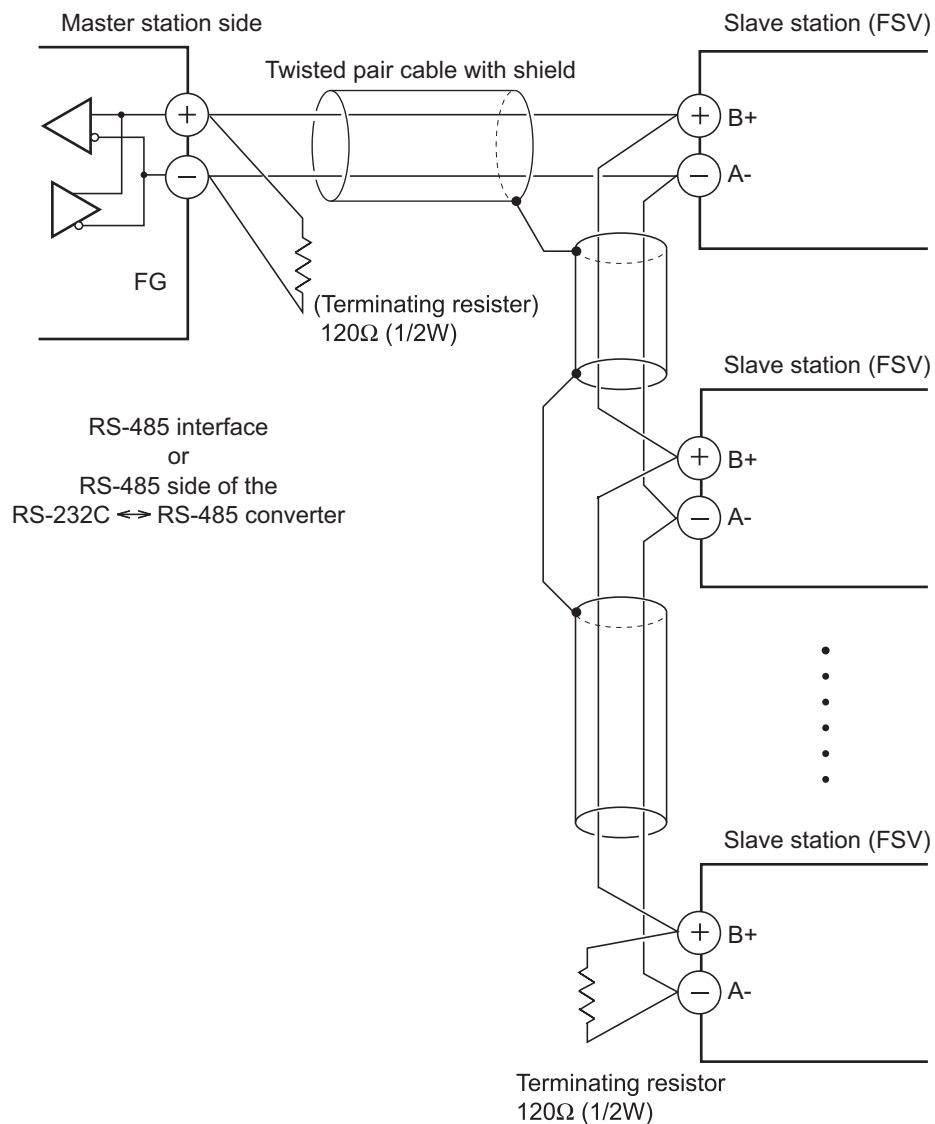
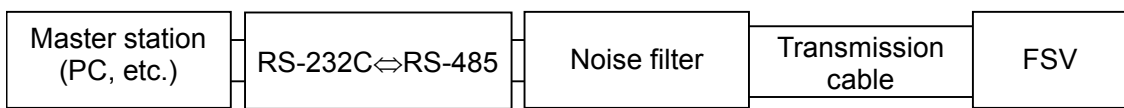

4. SETTING OF COMMUNICATION CONDITION

In order that the master station and instrument (this instrument) can correctly communicate, following settings are required.

- All communication condition settings of the master station are the same as those of instruments (this instrument).
- All instruments (this instrument) connected on a line are set to “Station No.” which are different from each other. Any “Station No.” is not shared by more than one instrument (when using the RS-485 interface).

4.1 Set Items

The parameters to be set are shown in the following table. Set them by operating the front panel keys.

Item	Value at delivery	Setting range	Remarks
Station No.	1	1 to 31 (0:communication function stop)	Set a different value to each station.
Transmission speed	9600 bps	9600 bps, 19200 bps, 38400 bps	Set the same communication condition to the master station and all slave stations.
Parity setting	Odd	None: None parity Odd: Odd parity Even: Even parity	
Data length	8 bits	Fixed (can not be changed)	
Stop bit	1 bit	1 bit, 2 bits	

4.2 Setting operation method

- (1) Make communication settings on the maintenance mode screen of the display setting area of the main unit. Refer to the separate instruction manual for “Fixed Type Ultrasonic Flowmeter,” INF-TN2FSVL-E, for the operation method.

5. MODBUS COMMUNICATION PROTOCOL

5.1 General

The communication system by the MODBUS protocol is that the communication is always started from the master station and a slave station responds to the received message.

Transmission procedures is as shown below.

- 1) The master station sends a command message to a slave station.
- 2) The slave station checks that the station No. in the received message matches with the own station No. or not.
- 3) If matched, the slave station executes the command and sends back the response message.
- 4) If mismatched, the slave station leaves the command message and wait for the next command message.

- a) In case when the station No. in the received command message matches with the own slave station No.

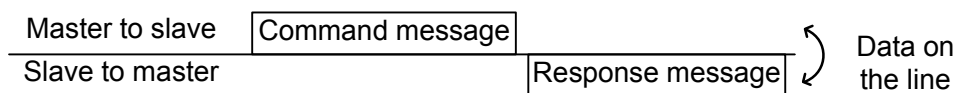

- b) In case when the station No. in the received command message mismatches with the own slave station No.

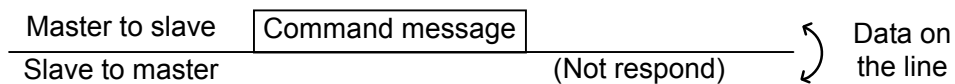

- 5) To assure safety, provide a structure where the response message is checked and retry is made three (3) times or more if no response is made or an error occurs.

The master station can individually communicate with any one of slave stations connected on the same line upon setting the station No. in the command message.

5.2 Composition of Message

Compositions of the command message and response message are as shown in Fig. 5-1. ; And these are sent in this order.

Station No. (1 byte)
Function code (1 byte)
Data (2 to 133 bytes)
Error check code (CRC-16) (2 bytes)

Fig. 5-1 Composition of message

In the following, each field is explained.

(1) Station No.

Station No. is the number specifying a slave station. When RS-485 interface is used, the command message is received and operated only by the slave station (FSV) whose station No. matches with the No. set in “Station No.”

For details of setting the parameter “Station No.,” refer to Chapter 4.

(2) Function code

This is a code to designate the function executed at a slave station.

For details, refer to Section 5.4.

(3) Data

Data are the data required for executing function codes. The composition of data varies with function codes. For details, refer to Chapter 6.

A register number is assigned to each data in the flowmeter. For reading/writing the data by communication, designate the register number.

Note that the register number transmitted on message is expressed as its relative address.

The relative address is calculated by the following expression.

$$\boxed{\text{Relative address}} = \left(\text{The lower 4 digits of the } \boxed{\text{register number}} \right) - 1$$

For example, when the register number designated by a function code is 40003,

$$\begin{aligned} \text{Relative address} &= (\text{lower 4 digits of } 40003) - 1 \\ &= 0002 \end{aligned}$$

is used on the message.

(4) Error check code

This is the code to detect message errors (change in bit) in the signal transmission.

On the MODBUS protocol (RTU mode), CRC-16 (Cyclic Redundancy Check) is applied.

For CRC calculation method, refer to Section 5.5.

5.3 Response of Slave Station

(1) Response for normal command

To a relevant message, the slave station creates and sends back a response message which corresponds to the command message. The composition of message in this case is the same as in Section 5.2.

Contents of the data field depend on the function code. For details, refer to Chapter 6.

(2) Response for abnormal command

If contents of a command message have an abnormality (for example, non-actual function code is designated) other than transmission error, the slave station does not execute that command but creates and sends back a response message at error detection.

The composition of response message at error detection is as shown in Fig. 5-2. The value used for function code field is function code of command message plus 80_H.

Table 5-1 gives error codes.

Station No.
Function code + 80 _H
Error code
Error check (CRC-16)

Fig. 5-2 Response message at error detection

Table 5-1 Error Code

Error code	Contents	Description
01H	Illegal function code	Non-actual function code is designated. Check for the function code.
02H	Illegal data address	A relative address of a register number to which the designated function code can not be used.
03H	Illegal data number	Because the designation of number is too much, the area where register numbers do not exist is designated.

(3) No response

Under any of the following items, the slave station takes no action of the command message and sends back no response.

- A station number transmitted in the command message differs from the station number specified to the slave station.
- A error check code is not matched, or a transmission error (parity error, etc.) is detected.
- The time interval between the composition data of the message becomes longer than the time corresponding to 24 bits. (Refer to Section 5.6 Transmission Control Procedure)
- Station No. of a slave station is set to 0.
- Setting is made on the main unit with the operation keys.
- The main unit displays a write-in command on a screen other than the measurement screen.

5.4 Function Code

According to MODBUS protocol, register numbers are assigned by function codes.

Each function code acts on specific register number.

This correspondence is shown in Table 5-2, and the message length by function is shown in Table 5-3.

Table 5-2 Correspondence between function codes and objective address

Function code			Resister No.		
No.	Function	Object	No.	Contents	
03 _H	Read-out (continuously)	Holding register	4xxxx	Read-out/write-in	word data
04 _H	Read-out (continuously)	Input register	3xxxx	Read-out	word data
06 _H	Write-in	Holding register	4xxxx	Read-out/write-in	word data
10 _H	Write-in (continuously)	Holding register	4xxxx	Read-out/write-in	word data

Table 5-3 Function code and message length

[Unit:byte]

Function code	Contents	Number of designatable data	Command message		Response message	
			Minimum	Maximum	Minimum	Maximum
03 _H	Read-out of word data	64 words	8	8	7	133
04 _H	Read-out of word data (read-out only)	64 words	8	8	7	133
06 _H	Write-in of word data	1 word	8	8	7	7
10 _H	Write-in of continuous word data	64 words	11	137	8	8

5.5 Calculation of Error Check Code (CRC-16)

CRC-16 is the 2-byte (16-bits) error check code. From the top of the message (station No.) to the end of the data field are calculated.

The slave station calculates the CRC of the received message, and does not respond if the calculated CRC is different from the contents of the received CRC code.

Fig. 5-3 shows the flow of the CRC-16 calculation system.

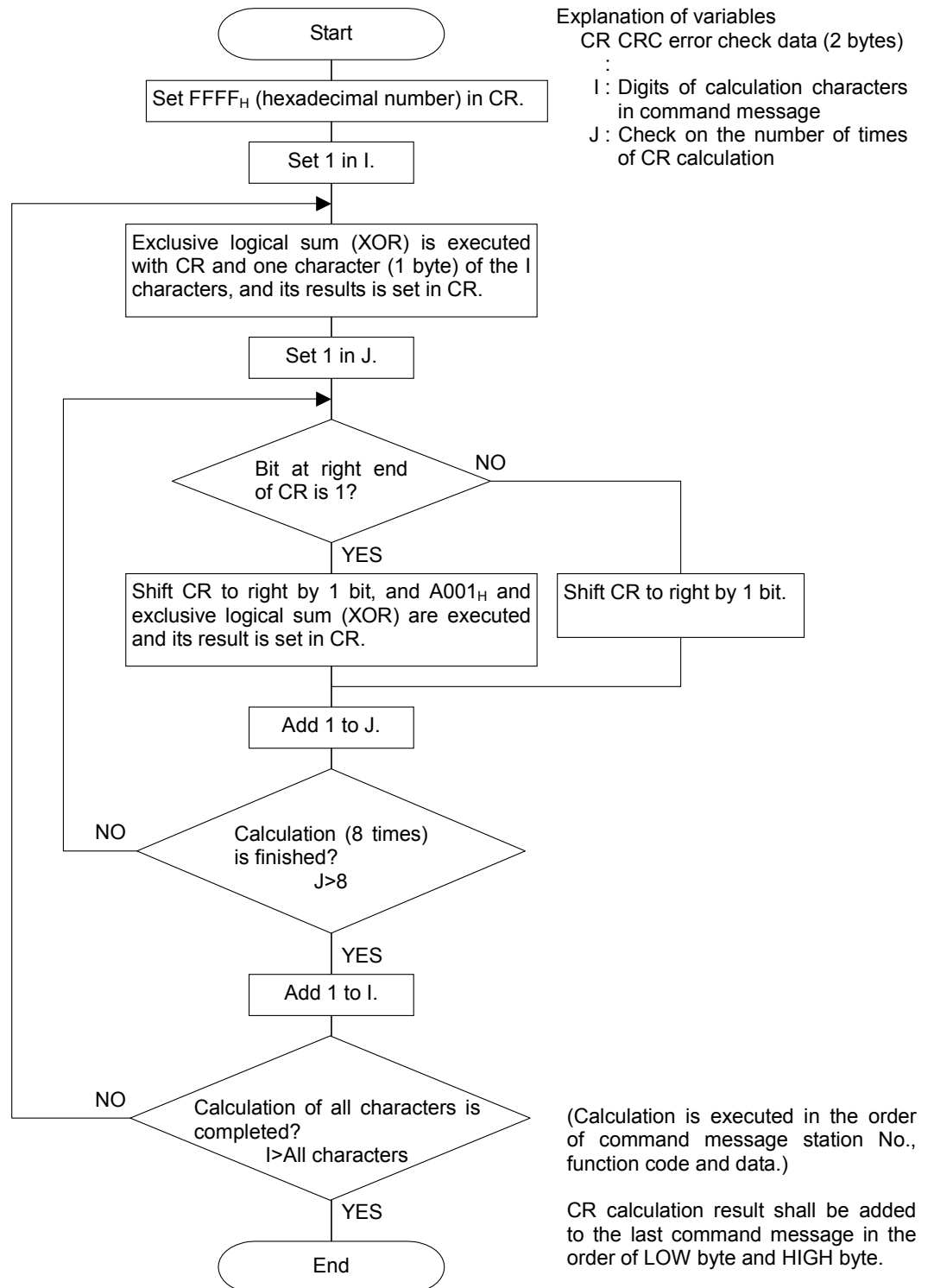

Fig. 5-3 Flow of CRC-16 calculation

5.6 Transmission Control Procedure

(1) Transmission procedure of master station

The master station must proceed to a communication upon conforming to the following items.

- (1-1) Before sending a command message, provide 48 bits time or more vacant status.
- (1-2) For sending, the interval between bytes of a command message is below 24 bits time.
- (1-3) Within 24 bits time after sending a command message, the receiving status is posted.
- (1-4) Provide 48 bits time or more vacant status between the end of response message reception and beginning of next command message sending [same as in (1-1)].
- (1-5) For ensuring the safety, make a confirmation of the response message and make an arrangement so as to provide 3 or more retries in case of no response, error occurrence, etc.

Note) The above definition is for most unfavorable value. For ensuring the safety, it's recommended the program of the master to work with safety factors of 2 to 3. Concretely, it is advised to arrange the program for 9600 bps with 10 ms or more for vacant status (1-1), and within 1 ms for byte interval (1-2) and changeover from sending to receiving (1-3).

(2) Description

1) Detection of the message frame

This communication system may be 2 statuses on a line below.

- (a) Vacant status (no data on line)
- (b) Communication status (data is existing)

Instruments connected on the line are initially at a receiving status and monitoring the line. When 24 bits time or more vacant status has appeared on the line, the end of preceding frame is assumed and, within following 24 bits time, a receiving status is posted. When data appears on the line, instruments receive it while 24 bits time or more vacant status is detected again, and the end of that frame is assumed. I.e., data which appeared on the line from the first 24 bits time or more vacant status to the next 24 bits time or more vacant status is fetched as one frame.

Therefore, one frame (command message) must be sent upon confirming the following.

- (1-1) 48 bits time or more vacant status precedes the command message sending.
- (1-2) Interval between bytes of 1 command message is smaller than 24 bits time.

2) Response of this instrument (FSV)

After a frame detection (24 bits time or more vacant status), this instrument carries out processing with that frame as a command message. If the command message is destined to the own station, a response message is returned. Its processing time is 5 to 60 ms (depends on contents of command message).

After sending a command message, therefore, the master station must observe the following

- (1-3) Receiving status is posted within 24 bits time after sending a command message.

Space time of longer than 25 ms is needed.

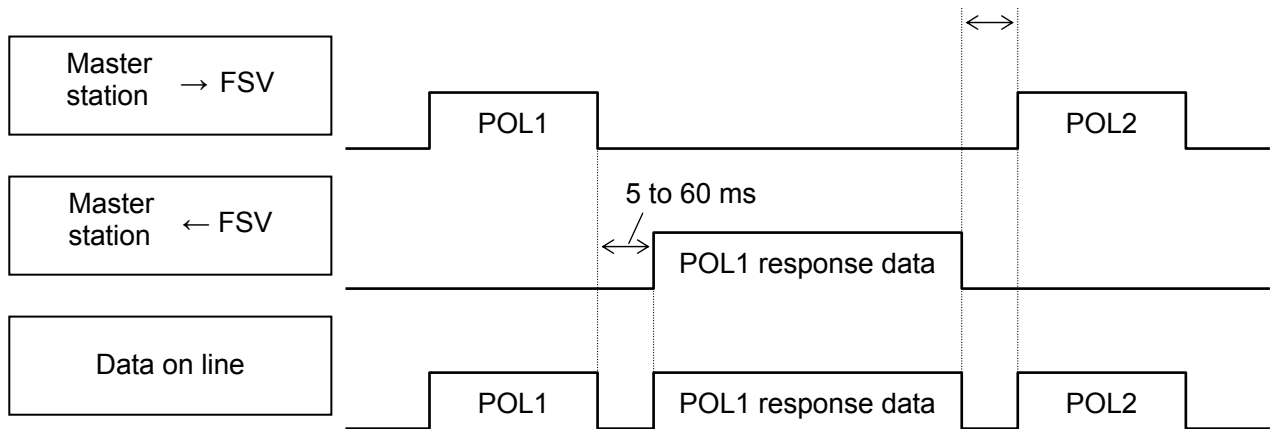

5.7 FIX Processing (Cautions in data write)

The instrument is provided inside with a non-volatile memory (FRAM) for holding the setting parameters.

Data written in the non-volatile memory is not lost even if turning off the power.

To hold parameters that were written in the internal memory via communication after turning off the power, the FIX process is effective. It allows parameters to be written in nonvolatile memory.

Fig.5-4 shows the FIX procedure.

Cautions:

- Write in the non-volatile memory takes approximately 2 seconds.
- While writing, do not turn off the power of the FSV. Otherwise, the data in the non-volatile memory will be destroyed, whereby the FSV could not be used any longer.
- Don't change parameters on the front panel when performing the FIX procedure, or memory error may result.
- Therefore, limit the times of change of parameter setting to absolute minimum. Refrain from carrying out the FIX processing periodically for example or while such is not absolutely required.

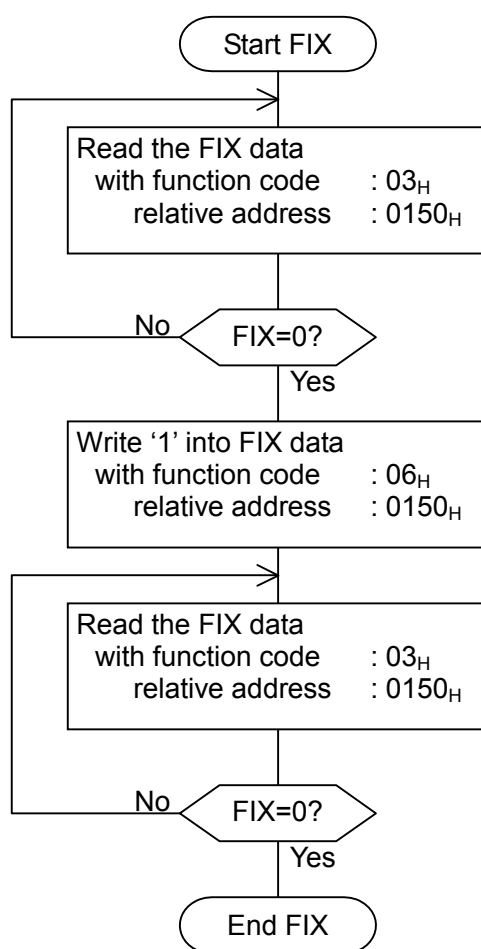

Fig.5-4 FIX procedure

6. DETAILS OF MESSAGE

6.1 Read-out of Word Data [Function code:03_H]

Function code	Max. word number read-out in one message	Relative data address	Register No.	Kind of data
03 _H	64 words	0000 _H —014F _H	40001—40336	Storage enable data
		03E8 _H —07CF _H	41001—42000	
1388 _H —14C9 _H	45001—45322			
1B5A _H —1BB1 _H	47003—47090			
		0150 _H —03E7 _H	40337—41000	Storage disable data

(1) Message composition

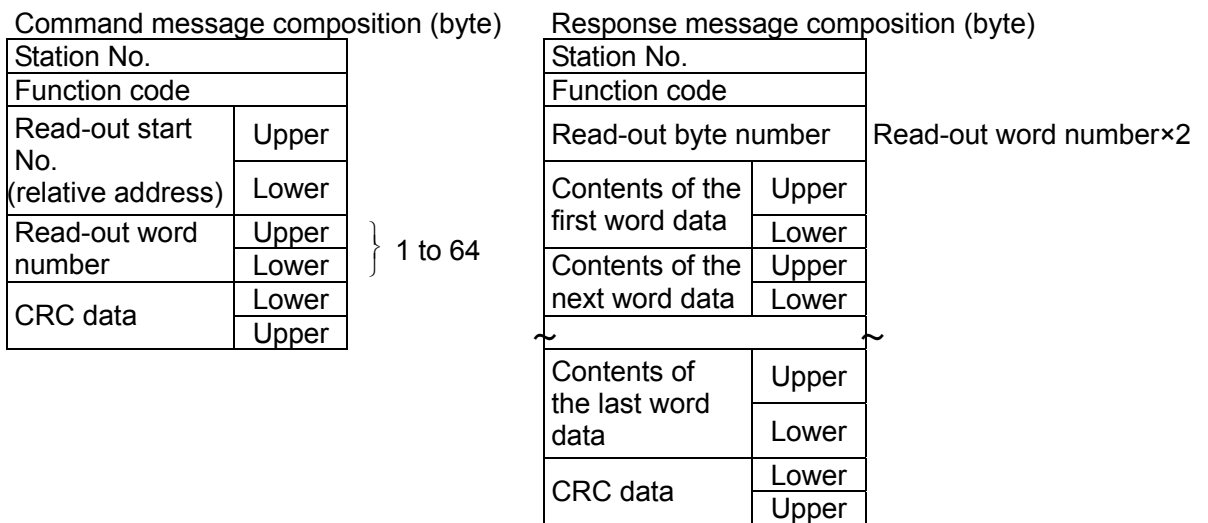

* Arrangement of read-out word data

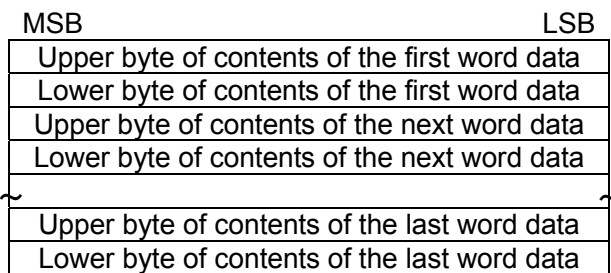

(2) Function explanations

Word data of continuous word numbers from the read-out start No. can be read. Read-out word data are transmitted from the slave station in the order of upper and lower bytes.

6.2 Read-out of Read-out Only Word Data [Function code:04_H]

Function code	Max. word number read-out in one message	Relative data address	Register No.
04 _H	64 words	0000 _H —00BF _H	30001—30192
		10C0 _H —10F7 _H	34289—34344
		1388 _H —104D _H	35001—35134
		2448 _H —247F _H	39289—39344
		251C _H —254B _H	39501—39548
		2648 _H —267F _H	39801—39856

(1) Message composition

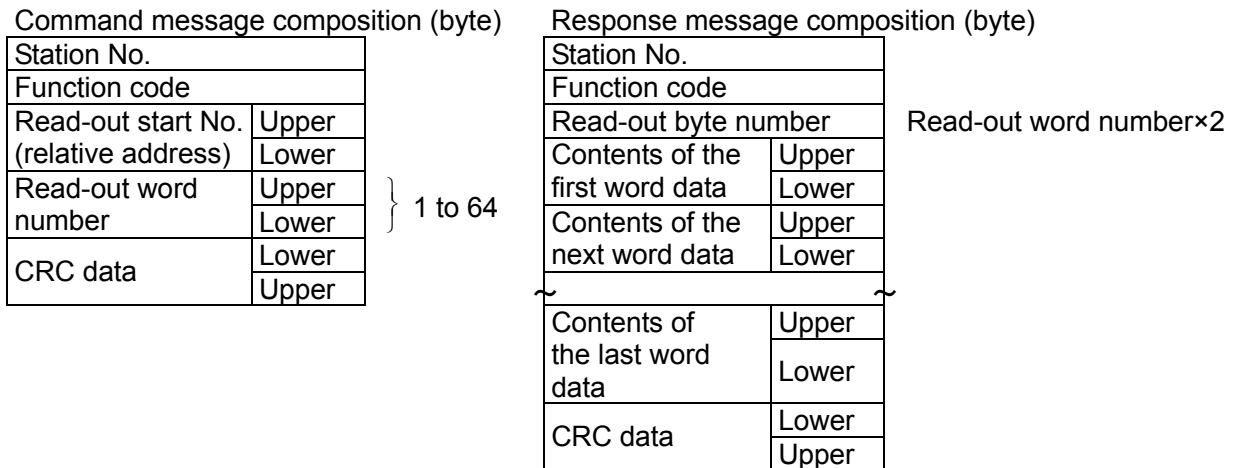

* Arrangement of read-out word data

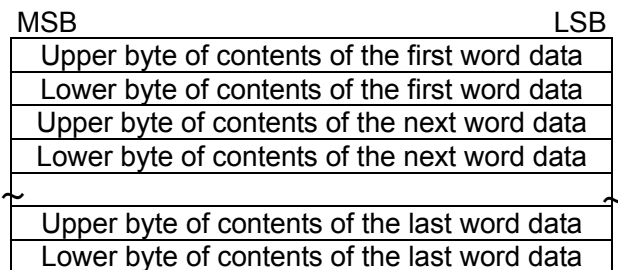

(2) Function explanations

Word data of continuous word numbers from the read-out start No. can be read. Read-out word data are transmitted from the slave station in the order of upper and lower bytes.

(3) Message transmission (example)

The following is an example of reading out the flow rate from station No. 1.

Relative address of the flow rate: 0004_H (Register No. 30005), Number of data to be read out: 02_H

Command message composition (byte)

Station No.		01 _H
Function code		04 _H
Read-out start No. (relative address)	Upper	00 _H
	Lower	04 _H
Read-out word number	Upper	00 _H
	Lower	02 _H
CRC data	Lower	30 _H
	Upper	0A _H

Response message composition (byte)

Station No.		01 _H
Function code		04 _H
Read-out byte number		04 _H
Contents of the first word data	Upper	43 _H
	Lower	40 _H
Contents of the next word data	Upper	00 _H
	Lower	00 _H
CRC data	Lower	EF _H
	Upper	D4 _H

Meaning of read-out data

Data having the unit m³/h and floating decimal point

The read-out data is expressed as a 32-bit single-precision floating value.

Connect the read-out 4-byte data, and convert it into an actual value using an appropriate conversion program.

Flow rate, 192.0 m³/h = 1.5x (2 to the 7th power)

$$= 0100\ 0011\ 0100\ 0000\ 0000\ 0000\ 0000\ 0000 \text{ (binary number)}$$

Refer to Section 7.1 for handling of floating data.

➤ **Point** ➤ For handling of floating data, refer to Section 7.1.

6.3 Write-in of Word Data [Function code:06_H]

Function code	Max. word number write-in in one message	Relative data address	Register No.	Kind of data
06 _H	1 word	0140H—014FH	40321—40336	Storage enable data
		14C8H—14C9H	45321—45322	
		0150 _H —0171 _H	40337—40370	Storage disable data

(1) Message composition

Command message composition (byte)

Station No.	
Function code	
Write-in designate No. (relative address)	Upper
	Lower
Write-in word data	Upper
	Lower
CRC data	Lower
	Upper

Response message composition (byte)

Station No.	
Function code	
Write-in designate No. (relative address)	Upper
	Lower
Write-in word data	Upper
	Lower
CRC data	Lower
	Upper

(2) Function explanation

Designated word data is written in write-in designate No. Write-in data are transmitted from master station in the order of upper and lower bytes.

The current value is returned when the write-in data does not fall within the effective range.

(3) Message transmission (example)

The following shows an example of transmitting the “Zero adjustment” key command to No.1 station.

Key operation command Relative address: 0140_H

Command message composition (byte)

Station No.		01 _H
Function code		06 _H
Write-in designate No. (relative address)	Upper	01 _H
	Lower	40 _H
Write-in word data	Upper	00 _H
	Lower	01 _H
CRC data	Lower	48 _H
	Upper	22 _H

} “Brightness UP” key command

Response message composition (byte)

Station No.		01 _H
Function code		06 _H
Write-in designate No. (relative address)	Upper	01 _H
	Lower	40 _H
Write-in word data	Upper	00 _H
	Lower	01 _H
CRC data	Lower	48 _H
	Upper	22 _H

6.4 Write-in of continuous word data [Function code:10_H]

Function code	Max. word number write-in in one message	Relative data address	Register No.	Kind of data
10 _H	64 word	0000H—013FH 03E8H—07CFH 1388H—14ABH 1B5AH—1BB1H	40001—40320 41001—42000 45001—45292 47003—47090	Storage enable data

(1) Message composition

Command message composition (byte)

Station No.	
Function code	
Write-in start No. (relative address)	Upper
	Lower
Write-in word number	Upper
	Lower
Write-in byte number	
First write-in word data	Upper
	Lower
Next write-in word data	Upper
	Lower
...	
Last write-in word data	Upper
	Lower
CRC data	Lower
	Upper

} 1 to 64

} Write-in word number × 2

Response message composition (byte)

Station No.	
Function code	
Write-in start No. (relative address)	Upper
	Lower
Write-in word number	Upper
	Lower
CRC data	Lower
	Upper

* Arrangement of write-in word data

MSB	LSB
Upper byte of contents of the first word data	
Lower byte of contents of the first word data	
Upper byte of contents of the next word data	
Lower byte of contents of the next word data	
...	
Upper byte of contents of the last word data	
Lower byte of contents of the last word data	

(2) Function explanation

Word data of continuous word number is written from write-in start address. Write-in word data are transmitted from master station in the order of upper and lower bytes.

If write-in data does not fall within the effective range, response is made without counting it as write-in word number. If an attempt is made to write data in an unused address, write-in is not performed, and response is made without counting it as write-in word number.

(3) Message transmission (example)

Writing Flow unit = m³/h, Range type = single range, Full scale 1 = 300.0 m³/h in No. 1 station is shown below.

Flow unit = 0006_H (= 6_D)

Range type = 0000_H (= 0_D)

Full scale 1 = 4072 C000 0000 0000 (= 300.0_D) (64-bit double precision float type)

Relative address of Flow unit: 0004_H (Register No. 40005), Data number: 06_H

Command message composition (byte)

Station No.		01 _H
Function code		10 _H
Write-in start No. (relative address)	Upper	00 _H
	Lower	04 _H
Write-in word number	Upper	00 _H
	Lower	06 _H
Write-in byte number		0C _H
First write-in word data	Upper	00 _H
	Lower	06 _H
Next write-in word data	Upper	00 _H
	Lower	00 _H
Next write-in word data	Upper	40 _H
	Lower	72 _H
Next write-in word data	Upper	C0 _H
	Lower	00 _H
Next write-in word data	Upper	00 _H
	Lower	00 _H
Last write-in word data	Upper	00 _H
	Lower	00 _H
CRC data	Lower	51 _H
	Upper	AB _H

Response message composition (byte)

Station No.		01 _H
Function code		10 _H
Write-in start No. (relative address)	Upper	00 _H
	Lower	04 _H
Write-in word number	Upper	00 _H
	Lower	06 _H
CRC data	Lower	01 _H
	Upper	CA _H



For handling of floating data, refer to Section 7.1.

For transmission format of each data, refer to the address map (Chapter 7.)

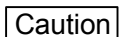

If the write-in command message is sent to any slave station during the FIX process, response is not returned from it.

7. ADDRESS MAP AND DATA FORMAT

7.1 Data Format

7.1.1 Transmission data format

The MODBUS protocol used in this product is RTU (Remote Terminal Unit) mode.
The transmitted data is “numerical value”, but ASCII code data is partly included.

7.1.2 Handling of decimal point

Numerical value data includes integer data, decimal point position fixed data and floating data. Handling of data containing a decimal point is described below.

(1) Data with determined decimal point position (int type, long type)

No decimal point is added in the transmission data. Execute decimal point position alignment processing (elimination of decimal point at the time of transmission, addition of decimal point at the time of reception) on data with decimal point.

Example: Case of damping data
 Read-out data: 03 E8_H = 1000
 Decimal point position: 1 digit
 Value: 100.0sec

(2) 32-bit floating data (float type)

Instantaneous values or the like are expressed by 32-bit single precision float type.
The meaning of each bit is as follows (standard format specified in IEEE).

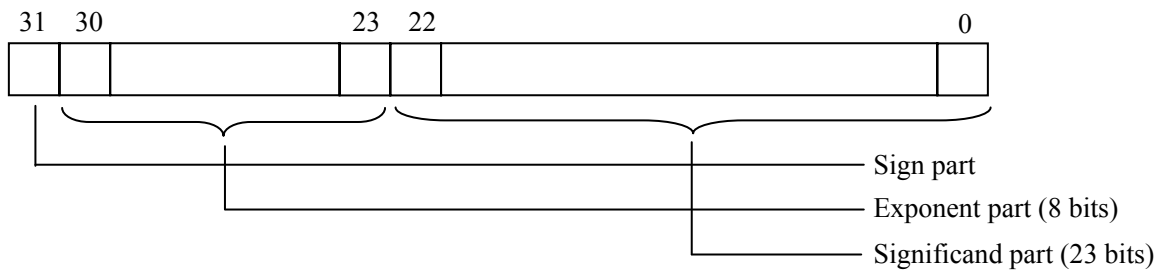

1) Sign part

Indicates the sign of the floating decimal point. “0” represents “positive”, and “1” represents “negative”.

2) Exponent part

Indicates the exponent of the floating decimal point by a power of 2. The value obtained by subtracting 127 from this value is the actual exponent.

3) Significand part

This is the data that corresponds to the significant figure of the floating decimal point. The actual numerical value is interpreted by adding 1 to the top.

Example: 1 10000000 11000000000000000000000
 Sign : Minus
 Exponent : $10000000_{(2)} - 127 = 1$
 Significand : $1.11_{(2)} = 1 + 1/2 + 1/4 = 1.75$
 Value : $-1.75 \times (1\text{st power of } 2) = -3.5$

7.2 Address Map

See the instruction manual attached to the main unit for details of functions and setting ranges of individual parameters.

Data type unsigned char: Byte data without sign. This data is handled in byte units. One data per address
 int : Word data with sign. This data is handled in word units. One data per two addresses
 unsigned int : Word data without sign. This data is handled in word units. One data per two addresses
 Long : 2-word data with sign. This data is handled in 2-word units. One data per four addresses
 float : Floating data. This data is handled in 2-word units. One data per four addresses
 double : Floating data. This data is handled in 4-word units. One data per eight addresses

7.2.1 Word data [Read-out/Write-in]: Function code [03H, 10H]

Path 1 Channel 1		Path 2 Channel 2		Calculated value Channel 3		Data type	Parameter	Read-out data/Write-in data setting range	Remarks
Relative address	Register No.	Relative address	Register No.	Relative address	Register No.				
	4XXXX								
0000	40001	1388	45001	—	—	int	Damping	1 place after the decimal point, 0.0 to 100.0sec	
0002	40003	138A	45003	1B5A	47003	Int	Range kind	0: Velocity, 1: Flow rate	* Range kind "Flow rate" only is available to CH3.
0004	40005	138C	45005	1B5C	47005	Int	Flow rate unit	Metric system: 0:L/s,1:L/min,2:L/h,3:L/d 4:kL/d,5:ML/d,6:m3/s, 7:m3/min,8:m3/h,9:m3/d, 10:km3/d,11:Mm3/d, 12:BBL/ s ,13:BBL/min, 14:BBL/h,15:BBL/d, 16:kBBL/d,17:MBBL/d English system: 0:gal/s,1:gal/min,2:gal/h 3:gal/d,4:kgal/d,5:Mgal/d 6:ft3/s,7:ft3/min,8:ft3/h 9:ft3/d,10:kft3/d, 11:Mft3/d,12:BBL/ s , 13:BBL/min,14:BBL/h, 15:BBL/d,16:kBBL/d, 17:MBBL/d	
0006	40007	138E	45007	1B5E	47007	Int	Range type	0: Single range, 1: Auto 2 range, 2: bi-directional range, 3: bi-directional auto 2 range	
0008	40009	1390	45009	1B60	47009	double	Full scale 1	Metric system: 64-bit floating data; 0, ±0.3 to ±32m/s as converted to flow rate English system: 64-bit floating data	Unit: Flow rate
0010	40017	1398	45017	1B68	47017	double	Full scale 2	Metric system: 64-bit floating data; 0, ±0.3 to ±32m/s as converted to flow rate English system: 64-bit floating data	Unit: Flow rate
0018	40025	13A0	45025	1B70	47025	Int	Hysteresis	2 places after the decimal point, 0.00 to 20.00%	
001A	40027	13A2	45027	1B72	47027	Int	Burnout	0: Not use, 1: Hold,	

Path 1 Channel 1		Path 2 Channel 2		Calculated value Channel 3		Data type	Parameter	Read-out data/Write-in data setting range	Remarks
Relative address	Register No.	Relative address	Register No.	Relative address	Register No.				
								2: Upper, 3: Lower, 4: Zero	
001C	40029	13A4	45029	1B74	47029	Int	Burnout timer	Decimal point fixed, 0 to 900sec	
001E	40031	13A6	45031	1B76	47031	Int	Output limit low	Decimal point fixed, -20 to 0%	
0020	40033	13A8	45033	1B78	47033	Int	Output limit high	Decimal point fixed, 100 to 120%	
0022	40035	13AA	45035	—	—	Int	Rate limit timer	Decimal point fixed, 0 to 900sec	
0024	40037	13AC	45037	—	—	double	Rate limit	Metric system: 64-bit floating data; 0 to 5m/s as converted to flow rate English system: 64-bit floating data	Unit: Flow rate
002C	40045	13B4	45045	—	—	double	Low flow rate cut	Metric system: 64-bit floating data; 0 to 5m/s as converted to flow rate English system: 64-bit floating data	Unit: Flow rate
0034	40053	13BC	45053	—	—	double	Calibration zero	64-bit floating data; ±5m/s as converted to flow rate English system: 64-bit floating data	Unit: Flow rate
003C	40061	13C4	45061	—	—	Int	Calibration span	2 places after the decimal point, 0.00 to 200.00%	
003E	40063	—	—	—	—	Int	Operation mode	0: Normal, 1: High speed response mode	
0040	40065	13C8	45065	1B98	47065	Int	Unit: Total * ¹	Metric system: 0: mL, 1: L, 2: m ³ , 3: km ³ , 4: Mm ³ , 5: mBBL, 6: BBL, 7: kBBL English system: 0: gal, 1: kgal, 2: ft ³ , 3: kft ³ 4: Mft ³ , 5: mBBL, 6: BBL, 7: kBBL, 8: ACRf	
0042	40067	13CA	45067	1B9A	47067	Int	Total mode	0: Start, 1: Stop, 2: Reset	
0044	40069	13CC	45069	1B9C	47069	double	Flow total rate * ¹	64-bit floating data, 0 to 99999999	Unit: Flow total rate
004C	40077	13D4	45077	1BA4	47077	double	Flow total preset * ¹	64-bit floating data, 0 to 99999999	Unit: Flow total rate
0054	40085	13DC	45085	1BAC	47085	Int	Pulse width * ¹	0:5.0msec、 1:10.0msec、 2:50.0msec、 3:100.0msec、 4:200.0msec、 5:500.0msec、 6:1000.0msec	
0056	40087	13DE	45087	1BAE	47087	Int	Burnout	0: Hold, 1: Not use	
0058	40089	13E0	45089	1BB0	47089	Int	Burnout timer	Decimal point fixed, 0 to 900sec	
005A	40091	—	—	—	—	Int	DO1 out	0: Not used, 1: +Total pulse, 2: -Total pulse, 3: Full scale 2, 4: Alarm, 5: Flow switch, 6: Total switch, 7: Ao range- over, 8: Pulse range-over, 9: -Flow direction, 10: H: Total pulse (Thermal), 11: C: Total pulse (Thermal), 12: Full scale 2 (Thermal), 13: Flow switch (Thermal), 14: Total switch (Thermal), 15: AO range over (Thermal), 16: P: Range over (Thermal),	

Path 1 Channel 1		Path 2 Channel 2		Calculated value Channel 3		Data type	Parameter	Read-out data/Write-in data setting range	Remarks
Relative address	Register No.	Relative address	Register No.	Relative address	Register No.				
								17: Air-conditioning, 18: Temperature alarm	
005C	40093	—	—	—	—	Int	DO1 Alarm	0: All, 1: Hardware fault, 2: Process error	
005E	40095	—	—	—	—	Int	DO1 Flow switch	0: Flow SW high, 1: Fow SW low	
0060	40097	—	—	—	—	double	DO1 flow SW high	Metric system: 64-bit floating data; 0 to 32m/s as converted to flow rate English system: 64-bit floating data	Unit: Flow rate
0068	40105	—	—	—	—	double	DO1 flow SW low	Metric system: 64-bit floating data; 0 to 32m/s as converted to flow rate English system: 64-bit floating data	Unit: Flow rate
0070	40113	—	—	—	—	double	DO1 total switch *1	64-bit floating data, 0 to 99999999	Unit: Flow total rate
0078	40121	—	—	—	—	Int	DO1 contact action	0: Active ON, 1: Active OFF	
007A	40123	—	—	—	—	Int	DO2 out	0: Not use, 1: +Total pulse, 2: -Total pulse, 3: Full scale 2, 4: Alarm, 5: Flow switch, 6: Total switch, 7: Ao range-over, 8: Pulse range-over, 9: -Flow direction, 10: H: Total pulse (Thermal), 11: C: Total pulse (Thermal), 12: Full scale 2 (Thermal), 13: Flow switch (Thermal), 14: Total switch (Thermal), 15: AO range over (Thermal), 16: P: Range over (Thermal), 17: Air-conditioning, 18: Temperature alarm	
007C	40125	—	—	—	—	Int	DO2 alarm	0: All, 1: Hardware fault, 2: Process error	
007E	40127	—	—	—	—	Int	DO2 flow switch	0: Flow SW high, 1: Fow SW low	
0080	40129	—	—	—	—	double	DO2 flow SW high	Metric system: 64-bit floating data; 0 to 32m/s as converted to flow rate English system: 64-bit floating data	Unit: Flow rate
0088	40137	—	—	—	—	double	DO2 flow SW low	Metric system: 64-bit floating data; 0 to 32m/s as converted to flow rate English system: 64-bit floating data	Unit: Flow rate
0090	40145	—	—	—	—	double	DO2 total switch *1	64-bit floating data, 0 to 99999999	Unit: Flow total rate
0098	40153	—	—	—	—	Int	DO2 contact action	0: Active ON, 1: Active OFF	
009A	40155	—	—	—	—	Int	DO3 out	0: Not use, 1: +Total pulse, 2: -Total pulse, 3: Full scale 2, 4: Alarm, 5: Flow switch, 6: Total switch, 7: Ao range-over, 8: Pulse range-over, 9: -Flow direction, 10: H: Total pulse (Thermal), 11: C: Total pulse (Thermal), 12: Full scale 2 (Thermal),	

Path 1 Channel 1		Path 2 Channel 2		Calculated value Channel 3		Data type	Parameter	Read-out data/Write-in data setting range	Remarks
Relative address	Register No.	Relative address	Register No.	Relative address	Register No.				
								13: Flow switch (Thermal), 14: Total switch (Thermal), 15: AO range over (Thermal), 16: P: Range over (Thermal), 17: Air-conditioning, 18: Temperature alarm	
009C	40157	—	—	—	—	Int	D03 alarm	0: All, 1: Hardware fault, 2: Process error	
009E	40159	—	—	—	—	Int	DO3 flow switch	0: Flow SW high, 1: Fow SW low	
00A0	40161	—	—	—	—	double	D03 flow SW high	Metric system: 64-bit floating data; 0 to 32m/s as converted to flow rate English system: 64-bit floating data	Unit: Flow rate
00A8	40169	—	—	—	—	double	D03 flow SW low	Metric system: 64-bit floating data; 0 to 32m/s as converted to flow rate English system: 64-bit floating data	Unit: Flow rate
00B0	40177					double	DO3 total switch *1	64-bit floating data, 0 to 99999999	Unit: Flow total rate
00B8	40185					Int	DO3 contact action	0: Active ON, 1: Active OFF	
00BA	40187	—	—	—	—	Int			write-in inhibit
00BC	40189	—	—	—	—	Int			write-in inhibit
00BE	40191	—	—	—	—	Int			write-in inhibit
00C0	40193	—	—	—	—	Int	1st row	0: Velocity, 1: Flow rate, 2: Flow rate (%), 3: + Total (actual), 4: + Total pulse, 5: -Total (actual), 6: -Total pulse, 7: H: Total (Thermal), 8: H:Total pulse (Thermal), 9: C: Total (Thermal) 10: C:Total pulse (Thermal), 11: Thermal flow, 12: Thermal flow (%), 13: Supply temp, 14: Return temp 15: Temperature difference	
00C2	40195	—	—	—	—	Int	Decimal point position of 1st row	0: * .*****, 1: **.*****, 2: ***.****, 3:****.***, 4: *****.**, 5: ******, 6: *****.	Writing is inhibited when "Velocity of flow," "+Total pulse," "-Total pulse," "Total heat pulse for heating," "Total heat pulse for cooling," or "Temperature" is selected on Display 1.
00C4	40197	—	—	—	—	Int	2nd row	0: Velocity, 1: Flow rate, 2: Flow rate (%), 3: + Total (actual), 4: + Total pulse, 5: -Total (actual), 6: -Total pulse, 7: H: Total (Thermal), 8: H:Total pulse (Thermal), 9: C: Total (Thermal) 10: C:Total pulse (Thermal), 11: Thermal flow,	

Path 1 Channel 1		Path 2 Channel 2		Calculated value Channel 3		Data type	Parameter	Read-out data/Write-in data setting range	Remarks
Relative address	Register No.	Relative address	Register No.	Relative address	Register No.				
								12: Thermal flow (%), 13: Supply temp, 14: Return temp 15: Temperature difference	
00C6	40199	—	—	—	—	Int	Decimal point position of 2nd row	0: * * * * * * * * 1: * * * * * * * * 2: * * * * * * * * 3: * * * * * * * * 4: * * * * * * * * 5: * * * * * * * * 6: * * * * * * * *	Writing is inhibited when "Velocity of flow," "+Total pulse," "-Total pulse," "Total heat pulse for heating," "Total heat pulse for cooling," or "Temperature" is selected on Display 2.
00C8	40201	—	—	—	—	Int	Select LCD backlight.	0: ON, 1: OFF	
00CA	40203	—	—	—	—	Int	LCD backlight out time	0 to 99 min	
00CC	40205	—	—	—	—	Int			write-in inhibit
00CE	40207	—	—	—	—	Int			write-in inhibit
00D0	40209	1458	45209	—	—	int	Sensor type	2: FSSA/FSSG, 3: FLS_12/FLS_22,4: FSSC, 5: FSG_32, 6: FSG_31/FSG_41 7: FSSE/FSG_50, 8: FSSF/FSG_51, 9: FSD12, 10: FSSD/FSD22, 11: FSSH/FSD32	
00D2	40211	145A	45211	—	—	long	Outside diameter	Metric system: 2 places after decimal point, 6.00 to 6200.00mm English system: 4 places after decimal point, 0.2362 to 244.100inch	
00D6	40215	145E	45215	—	—	int	Pipe material	0: Carbon steel, 1: Stainless steel, 2: PVC, 3: Copper, 4: Cast iron, 5: Aluminum, 6: FRP, 7: Ductile iron, 8: PEEK, 9: PVDF, 10: Acrylic, 11: PP, 12: Pipe S.V.	
00D8	40217	1460	45217	—	—	int	Pipe sound velocity	Metric system: Decimal point fixed, 1000 to 3700m/s English system: Decimal point fixed, 3280 to 12140ft/s	Write-in is permitted in case pipe material is "12: Pipe S.V."
00DA	40219	1462	45219	—	—	long	Pipe wall thickness	Metric system: 2 places after decimal point, 0.10 to 100.00mm English system: 4 places after decimal point, 0.0039 to 3.9380inch	
00DE	40223	1466	45223	—	—	int	Lining material	0: No lining, 1: Tar epoxy, 2: Mortar, 3: Rubber, 4: Teflon, 5: Pyrex glass, 6: PVC, 7: Lining S.V.	
00E0	40225	1468	45225	—	—	int	Lining sound velocity	Metric system: Decimal point fixed,1000 to 3700m/s English system: Decimal point fixed, 3280 to 12140ft/s	Write-in is permitted in case lining material is "7: Lining S.V."

Path 1 Channel 1		Path 2 Channel 2		Calculated value Channel 3		Data type	Parameter	Read-out data/Write-in data setting range	Remarks
Relative address	Register No.	Relative address	Register No.	Relative address	Register No.				
00E2	40227	146A	45227	—	—	long	Lining thickness	Metric system: 2 places after decimal point, 0.010 to 100.00mm English system: 4 places after decimal point, 0.0003 to 3.9380inch	
00E6	40231	146E	45231	—	—	int	Kind of fluid	0: Water, 1: Seawater, 2: Distilled water, 3: Ammonia, 4: Alcohol, 5: Benzene, 6: Bromide, 7: Ethanol, 8: Glycol, 9: Kerosene, 10: Milk, 11: Methanol, 12: Toluol, 13: Lube oil, 14: Fuel oil, 15: Petrol, 16: Refrigerant R410, 17: Fluid S.V.	
00E8	40233	1470	45233	—	—	int	Fluid sound velocity	Metric system: Decimal point fixed,300 to 2500m/s English system: Decimal point fixed984 to 8203ft/s	Write-in is permitted in case lining material is “17: Fluid S.V.
00EA	40235	1472	45235	—	—	double	Viscosity	Metric system: 32-bit floating data,0.001 to 999.999 E ⁻⁶ m ² /s English system: 32-bit floating data,0.0107 to 10764 E ⁻⁶ ft ² /s	
00F2	40243	147A	45243	—	—	int	Sensor mount	0: V method, 1:Z method	
00F4	40245	147C	45245	—	—	int			write-in inhibit
~	~	—	—	—	—	int			write-in inhibit
00FE	40255	—	—	—	—	int			write-in inhibit
0100	40257	—	—	—	—	int	System unit *1	0: meter, 1: inch	
0102	40259	—	—	—	—	int	Language	0: English, 1: Japanese, 2: German, 3: French, 4: Spanish	
0104	40261	—	—	—	—	int	ID No. setup	Decimal point fixed,0 to 9999	
0106	40263	148E	45263	—	—	int	Transmission count	Normal operation mode: 1: 8, 2: 16, 3: 32, 4: 64, 5: 128, 6: 256 High speed operation mode: 0: 4, 1: 8, 2: 16, 3: 32, 4: 64, 5: 128	
0108	40265	1490	45265	—	—	int	Trigger control	0: Auto, 1: Manual	
010A	40267	1492	45267	—	—	int	Trigger level	Decimal point fixed,10 to 90%	
010C	40269	1494	45269	—	—	int	Window control	0: Auto, 1: Manual	
010E	40271	1496	45271	—	—	int	U: Open time	Decimal point fixed,1 to 16383	
0110	40273	1498	45273	—	—	int	D: Open time	Decimal point fixed,1 to 16383	
0112	40275	149A	45275	—	—	int	Saturation	Decimal point fixed,0 to 512	
0114	40277	149C	45277	—	—	int	Measure method	0: Method 1, 1: Method 2, 2: Method 3	
0116	40279	149E	45279	—	—	int	Wave receiving balance	Decimal point fixed,0 to 100%	
0118	40281	14A0	45281	—	—	int	Transmission pattern	0: Burst 1, 1: Burst 2, 2: Burst 3, 3: Burst 4, 4: Burst 5, 5: Chirp 4, 6: Chirp 8, 7: Reserve	

Path 1 Channel 1		Path 2 Channel 2		Calculated value Channel 3		Data type	Parameter	Read-out data/Write-in data setting range	Remarks
Relative address	Register No.	Relative address	Register No.	Relative address	Register No.				
011A	40283	14A2	45283	—	—	int	AGC gain	0: Auto, 1: Manual	
011C	40285	14A4	45285	—	—	int	U: AGC	2 places after decimal point1.28 to 98.56	
011E	40287	14A6	45287	—	—	int	D: AGC	2 places after decimal point1.28 to 98.56	
0120	40289	14A8	45289	—	—	int	Wave receiving peak	0:0.125V(1024), 1:0.25V(2048), 2:0.375V(3072), 3:0.5V(4096)	
0122	40291	14AA	45291	—	—	int	Transmission wait time	Decimal point fixed, 5 to 30msec	
0124	40293	—	—	—	—	int			write-in inhibit
~	~	—	—	—	—				write-in inhibit
013E	40319	—	—	—	—	int			write-in inhibit
03E8	41001	—	—	—	—	int	Measurement setting	0: 1 measurement line, 1: 2 measurement line, 2: 2 pipe	
03EA	41003	—	—	—	—	int	CH3 calculation output	0: Average, 1: additional value, 2: Difference (CH1 - CH2), 3: Difference (CH2 - CH1)	
03EC	41005	—	—	—	—	int	AO1 output source	0: CH1: Flow rate, 1: CH2: Flow rate, 2: CH3: Flow rate, 3: CH1 Heat, 4: CH2: Heat, 5:CH3: Heat	
03EE	41007	—	—	—	—	int	AO2 output source	0: CH1: Flow rate, 1: CH2: Flow rate, 2: CH3: Flow rate, 3: CH1 Heat, 4: CH2: Heat, 5:CH3: Heat	
03F0	41009	—	—	—	—	double	Heat Range Full Scale 1	64-bit floating data, ±99999999	Unit: Thermal unit
03F8	41017	—	—	—	—	double	Heat Range Full Scale 2	64-bit floating data, ±99999999	Unit: Thermal unit
0400	41025	—	—	—	—	double	Total heat rate * ¹	64-bit floating data, 0 to 99999999	Unit: Thermal unit
0408	41033	—	—	—	—	double	Total heat resetting * ¹	64-bit floating data, 0 to 99999999	Unit: Thermal unit
0410	41041	—	—	—	—	Int	D04 output	0: Not use, 1: +Total pulse, 2: -Total pulse, 3: Full scale 2, 4: Alarm, 5: Flow switch, 6: Total switch, 7: Ao range-over, 8: Pulse range-over, 9: -Flow direction, 10: H: Total pulse (Thermal), 11: C: Total pulse (Thermal), 12: Full scale 2 (Thermal), 13: Flow switch (Thermal), 14: Total switch (Thermal), 15: AO range over (Thermal), 16: P: Range over (Thermal), 17: Air-conditioning, 18: Temperature alarm	
0412	41043	—	—	—	—	Int	D04 alarm	0: All, 1: Hardware fault, 2: Process error	
0414	41045	—	—	—	—	Int	DO4 flow switch	0: Flow SW high, 1: Fow SW low	
0416	41047	—	—	—	—	double	DO4 fow SW high	Metric system: 64-bit floating data; 0 to 32m/s as converted to flow rate English system: 64-bit floating data	Unit: Flow rate

Path 1 Channel 1		Path 2 Channel 2		Calculated value Channel 3		Data type	Parameter	Read-out data/Write-in data setting range	Remarks
Relative address	Register No.	Relative address	Register No.	Relative address	Register No.				
041E	41055	—	—	—	—	double	D04 fow SW low	Metric system: 64-bit floating data; 0 to 32m/s as converted to flow rate English system: 64-bit floating data	Unit: Flow rate
0426	41063	—	—	—	—	double	DO4 total switch *1	64-bit floating data, 0 to 99999999	Unit: Flow total rate
042E	41071	—	—	—	—	Int	DO4 contact action	0: Active ON, 1: Active OFF	
0430	41073	—	—	—	—	int	DO1 Fow switch (thermal)	0: Fow SW high (T) 1: Fow SW low (T)	
0432	41075	—	—	—	—	double	DO1 Fow SW high (T)	64-bit floating data, 0 to 99999999	Unit: Thermal unit
043A	41083	—	—	—	—	double	DO1 Fow SW low (T)	64-bit floating data, 0 to 99999999	Unit: Thermal unit
0442	41091					double	DO1 total switch (thermal) *1	64-bit floating data, 0 to 99999999	Unit: Total unit (thermal)
044A	41099	—	—	—	—	int	DO2 Fow switch (Thermal)	0: Fow SW high (T) 1: Fow SW low (T)	
044C	41101	—	—	—	—	double	DO2 Fow SW high (T)	64-bit floating data, 0 to 99999999	Unit: Thermal unit
0454	41109	—	—	—	—	double	DO2 Fow SW low (T)	64-bit floating data, 0 to 99999999	Unit: Thermal unit
045C	41117					double	DO2 total switch (thermal) *1	64-bit floating data, 0 to 99999999	Unit: Total unit (thermal)
0464	41125	—	—	—	—	int	DO3 Fow switch (thermal)	0: Fow SW high (T) 1: Fow SW low (T)	
0466	41127	—	—	—	—	double	DO3 Fow SW high (T)	64-bit floating data, 0 to 99999999	Unit: Thermal unit
046E	41135	—	—	—	—	double	DO3 Fow SW low (T)	64-bit floating data, 0 to 99999999	Unit: Thermal unit
0476	41143					double	DO3 total switch (thermal) *1	64-bit floating data, 0 to 99999999	Unit: Total unit (thermal)
047E	41151	—	—	—	—	int	DO4 Fow switch (Thermal)	0: Fow SW high (T) 1: Fow SW low (T)	
0480	41153	—	—	—	—	double	DO4 Fow SW high (T)	64-bit floating data, 0 to 99999999	Unit: Thermal unit
0488	41161	—	—	—	—	double	DO4 Fow SW low (T)	64-bit floating data, 0 to 99999999	Unit: Thermal unit
0490	41169					double	DO4 Total switch (thermal) *1	64-bit floating data, 0 to 99999999	Unit: Total unit (thermal)
0498	41177	—	—	—	—	double			write-in inhibit
04A0	41185	—	—	—	—	double			write-in inhibit
04A8	41193	—	—	—	—	int	DO1 Output source channel	0: CH1, 1: CH2, 2: CH3	
04AA	41195	—	—	—	—	int	DO2 Output source channel	0: CH1, 1: CH2, 2: CH3	
04AC	41197					int	DO3 Output source channel	0: CH1, 1: CH2, 2: CH3	
04AE	41199					int	DO4 Output source channel	0: CH1, 1: CH2, 2: CH3	
04B0	41201	—	—	—	—	int	Display 1	0: CH1, 1: CH2, 2: CH3	

Path 1 Channel 1		Path 2 Channel 2		Calculated value Channel 3		Data type	Parameter	Read-out data/Write-in data setting range	Remarks
Relative address	Register No.	Relative address	Register No.	Relative address	Register No.				
							Output source channel		
04B2	41203	—	—	—	—	int	Display 2 Output source channel	0: CH1, 1: CH2, 2: CH3	
04B4	41205	—	—	—	—	int	Temperature unit	Metric system: 0: °C 1: K, 2: F English system: 0: °C, 1: K, 2: F	
04B6	41207	—	—	—	—	int	Thermal unit	0: MJ/h, 1: GJ/h, 2: BTU/h, 3: kBTU/h, 4: MBTU/h, 5: kWh, 6: MWh	
04B8	41209	—	—	—	—	int	Total unit (thermal)	0: MJ, 1: GJ, 2: BTU, 3: kBTU, 4: MBTU, 5: kW, 6: MW	
04BA	41211	—	—	—	—	int	Mode	0: Not use, 1: Use	
04BC	41213	—	—	—	—	int	Operation	0: Cooling operation, 1: Heating operation, 2: Air-conditioning	
04BE	41215	—	—	—	—	int	Temperature input: Supply flow temperature	0: TS temperature input, 1: Temperature setting	
04C0	41217	—	—	—	—	int	Temperature input: Return flow temperature	0: TR temperature input, 1: Temperature setting	
04C2	41219	—	—	—	—	int	Temperature input signal	0: Not use, 1: Pt100	
04C4	41221	—	—	—	—	double	Thermal coefficient for cooling	1.000 to 9.999	Coolins operation
04CC	41229	—	—	—	—	double	Thermal coefficient for heating	1.000 to 9.999	Heating operation
04D4	41237	—	—	—	—	double	Air- conditioning: Switching temperature	64-bit floating data, -40 to 240°C [-40.0F to 464.0F]	Unit: Temperature unit
04DC	41245	—	—	—	—	double	Air- conditioning: Hysteresis	64-bit floating data, -40 to 240°C [-40.0F to 464.0F]	Unit: Temperature unit
04E4	41253	—	—	—	—	double	Supply flow: Temperature setting	64-bit floating data, -40 to 240°C [-40.0F to 464.0F]	Unit: Temperature unit
04EC	41261	—	—	—	—	double	Return flow: Temperature setting	64-bit floating data, -40 to 240°C [-40.0F to 464.0F]	Unit: Temperature unit
04F4	41269	—	—	—	—	double	Supply flow: Temperature calibration zero	64-bit floating data, -40 to 40°C [-40.0F to 104.0F]	Unit: Temperature unit
04FC	41277	—	—	—	—	double	Supply flow: Temperature calibration span	64-bit floating data, 50 to 150%	
0504	41285	—	—	—	—	double	Return flow: Temperature calibration zero	64-bit floating data, -40 to 40°C [-40.0F to 104.0F]	Unit: Temperature unit
050C	41293	—	—	—	—	double	Return flow: Temperature calibration span	64-bit floating data, 50 to 150%	

Path 1 Channel 1		Path 2 Channel 2		Calculated value Channel 3		Data type	Parameter	Read-out data/Write-in data setting range	Remarks
Relative address	Register No.	Relative address	Register No.	Relative address	Register No.				
0514	41301	—	—	—	—	Int	Supply flow: Damping	Decimal point fixed, 0 to 120sec	
0516	41303	—	—	—	—	Int	Return flow: Damping	Decimal point fixed, 0 to 120sec	
0518	41305	—	—	—	—				write-in inhibit
~	~	—	—	—	—				write-in inhibit
07CF	42000	—	—	—	—				write-in inhibit

*1) Total set value and system unit may be set only in the state where the total mode is stop. (If write-in is attempted without stopping, response occurs without counting in the write-in byte count.)

*2) Read only in the setting screen. No response is made against write-in. Setting from communication is permitted only in the protected state.

7.2.2 Word data [Read-out/Write-in]: Function code [03H, 06H]

Path 1 Channel 1		Path 2 Channel 2		Calculated value Channel 3		Data type	Parameter	Read-out data/Write-in data setting range	Remarks
Relative address	Register No.	Relative address	Register No.	Relative address	Register No.				
0140	40321	14C8	45321	—	—	int	Zero adjustment	0: Clear, 1: Adjust	
0142	40323	—	—	—	—	unsigne d int	AO1 4mA adjustment	No decimal point, 50 to 7148	
0144	40325	—	—	—	—	unsigne d int	AO1 20mA adjustment	No decimal point, 7148 to 15950	
0146	40327	—	—	—	—	int			write-in inhibit
0148	40329	—	—	—	—	int			write-in inhibit
014A	40331	—	—	—	—	unsigne d int	AO2 4mA adjustment	No decimal point, 50 to 7148	
014C	40333	—	—	—	—	unsigne d int	AO2 20mA adjustment	No decimal point, 7148 to 15950	
014E	40335	—	—	—	—	int			write-in inhibit

The address data indicated below is not stored in the main unit.

Path 1 Channel 1		Path 2 Channel 2		Calculated value Channel 3		Data type	Parameter Content	Read-out data/Write-in data setting range	Remarks
Relative address	Register No.	Relative address	Register No.	Relative address	Register No.				
0150	40337	—	—	—	—	int	Set value storage request	Read-out data: 0: Completed, 1: Being stored Write-in data: 1: Storage	
0152	40339	—	—	—	—	int	Memory initialize	Read-out data: 0 Write-in data: 0100: Initialize	Communication is disabled for about 5 seconds after initialization.
0154	40341	—	—	—	—	int	Current check	Decimal point fixed, -20 to 120%	
0156	40343	—	—	—	—	int	Total pulse check	Decimal point fixed, 1 to 100PULSE/s	
0158	40345	—	—	—	—	int	DO check	0: ON, 1: OFF	
015A	40347	—	—	—	—	int			write-in inhibit
015C	40349	—	—	—	—	int	Test mode	0: Not use, 1: Set	
015E	40351	—	—	—	—	int	Input data	Decimal point fixed,±120%	
0160	40353	—	—	—	—	int	Tracking time	Decimal point fixed,0 to 900sec	

Path 1 Channel 1		Path 2 Channel 2		Calculated value Channel 3		Data type	Parameter Content	Read-out data/Write-in data setting range	Remarks
Relative address	Register No.	Relative address	Register No.	Relative address	Register No.				
0162	40355	—	—	—	—	int	LCD & LED check *3	0: Not use, 1: Check	
0164	40357	—	—	—	—	int	Key test *3	Read-out data: 10: No key pressing, 20: ESC key, 40: Ukey, 80: ENT key, 100: SHIFT key Write-in data: 0: Not use, 1: Start	
0166	40359	—	—	—	—	int	Test cancel	Read-out data: 0: Termination, 1: Being tested Write-in data : 0: Termination	Cancellation of testing of current, total pulse, DO check and test mode
0168	40361	—	—	—	—	int			write-in inhibit
~	~	—	—	—	—				write-in inhibit
03E7	41000	—	—	—	—	int			write-in inhibit

*3) No response is made if execution is attempted in a screen other than measure screen.

7.2.3 Word data [Read-out only]: Function code [04H]

Path 1 Channel 1		Path 2 Channel 2		Calculated value Channel 3		Data type	Parameter	Read-out data	Remarks
Relative address	Register No.	Relative address	Register No.	Relative address	Register No.				
	3XXX X								
0000	30001	1388	35001	251C	39501	float	Velocity	Metric system: 32-bit floating data, Unit: m/s English system: 32-bit floating data, Unit: ft/s	
0004	30005	138C	35005	2520	39505	float	Flow rate	32-bit floating data	Unit: Flow rate
0008	30009	1390	35009	2524	39509	float	Flow rate %	32-bit floating data	Unit: %
000C	30013	1394	35013	2528	39513	double	+ Total value	64-bit floating data	Unit: Total
0014	30021	139C	35021	2530	39521	double	- Total value	64-bit floating data	
001C	30029	13A4	35029	2538	39529	long	+ Total pulse	No decimal point	Unit: Pulse
0020	30033	13A8	35033	253C	39533	long	- Total pulse	No decimal point	Unit: Pulse
0024	30037	13AC	35037	2540	39537	unsigned int	RAS information	Data of hexadecimal number	
0026	30039	13AE	35039	2542	39539	int			write-in inhibit
0028	30041	13B0	35041	2544	39541	int			write-in inhibit
~	~	—	—	—	—				write-in inhibit
002E	30047	13B6	35047	254A	39547	int			write-in inhibit
0030	30049	13B8	35049	—	—	int	Wedge sound velocity	Metric system: No decimal point, Unit: m/s English system: No decimal point, Unit: ft/s	
0032	30051	13BA	35051	—	—	int	Wedge incidence angle	1 place after decimal point, Unit: °	
0034	30053	13BC	35053	—	—	int	Pipe sound velocity	Metric system: No decimal point, Unit: m/s English system: No decimal point, Unit: ft/s	
0036	30055	13BE	35055	—	—	int	Pipe incidence angle	1 place after decimal point, Unit: °	

Path 1 Channel 1		Path 2 Channel 2		Calculated value Channel 3		Data type	Parameter	Read-out data	Remarks
Relative address	Register No.	Relative address	Register No.	Relative address	Register No.				
0038	30057	13C0	35057	—	—	int	Lining sound velocity	Metric system: No decimal point, Unit: m/s English system: No decimal point, Unit: ft/s	
003A	30059	13C2	35059	—	—	int	Lining incidence angle	1 place after decimal point	
003C	30061	13C4	35061	—	—	int	Fluid sound velocity	Metric system: No decimal point, Unit: m/s English system: No decimal point, Unit: ft/s	
003E	30063	13C6	35063	—	—	int	Water incidence angle	1 place after decimal point, Unit: °	
0040	30065	13C8	35065	—	—	int	Propagation time (T0 C)	No decimal point, Unit: μs	
0042	30067	13CA	35067	—	—	int	Window open (Win C)	No decimal point, Unit: μs	
0044	30069	13CC	35069	—	—	long	Positive direction time (T1)	3 places after decimal point, Unit: μs	
0048	30073	13D0	35073	—	—	long	Backward direction time (T2)	3 places after decimal point, Unit: μs	
004C	30077	13D4	35077	—	—	long	Propagation time (T0)	3 places after decimal point, Unit: μs	
0050	30081	13D8	35081	—	—	long	Propagation time difference (DT)	4 places after decimal point, Unit: ns	
0054	30085	13DC	35085	—	—	long	Delay time (Ta)	3 places after decimal point, Unit: μs	
0058	30089	13E0	35089	—	—	long	Water incidence angle (θf)	3 place after decimal point, Unit: °	
005C	30093	13E4	35093	—	—	long	Fluid sound velocity (Cf)	Metric system: 1 places after decimal point, Unit: m/s English system: 1 places after decimal point, Unit: ft/s	
0060	30097	13E8	35097	—	—	long	Reynolds number (Re)	No decimal point	
0064	30101	13EC	35101	—	—	long	Flow profile compensatio n factor (K)	4 place after decimal point	
0068	30105	13F0	35105	—	—	long	Flow velocity (V)	Metric system: 3 places after decimal point, Unit: m/s English system: 3 places after decimal point, Unit: ft/s	
006C	30109	13F4	35109	—	—	int	U: Signal strength (AGC U)	2 places after decimal point, 0.00 to 100.00%	
006E	30111	13F6	35111	—	—	int	D: Signal strength (AGC D)	2 places after decimal point, 0.00 to 100.00%	
0070	30113	13F8	35113	—	—	unsigned int	U: Maximum signal value (P/H U)	No decimal point	
0072	30115	13FA	35115	—	—	unsigned int	D: Maximum	No decimal point	

Path 1 Channel 1		Path 2 Channel 2		Calculated value Channel 3		Data type	Parameter	Read-out data	Remarks
Relative address	Register No.	Relative address	Register No.	Relative address	Register No.				
							signal value (P/H D)		
0074	30117	13FC	35117	—	—	int	U:Trigger level (TRG U)	2 places after decimal point, 0.00 to 100.00%	
0076	30119	13FE	35119	—	—	int	D:Trigger level (TRG D)	2 places after decimal point, 0.00 to 100.00%	
0078	30121	1400	35121	—	—	long	U: Maximum filter value	No decimal point	
007C	30125	1404	35125	—	—	long	D: Maximum filter value	No decimal point	
0080	30129	1408	35129	—	—	long	Sensor spacing 1	Metric system: 2 places after decimal point, Unit: mm English system: 3 places after decimal point, Unit: inch	
0084	30133	140C	35133	—	—	unsigned int	Sensor spacing 2	No decimal point	Cases of FLS_12, FLS_22, FSSA, FSSG sensors
0086	30135	—	—	—	—	unsigned char	1st and 2nd characters of version	10 characters of ASCII code	
0088	30137	—	—	—	—	unsigned char	3rd and 4th characters of version		
008A	30139	—	—	—	—	unsigned char	5th and 6th characters of version		
008C	30141	—	—	—	—	unsigned char	7th and 8th characters of version		
008E	30143	—	—	—	—	unsigned char	9th and 10th characters of version		
0090	30145	—	—	—	—	unsigned char	11th and 12th characters of version		
0092	30147	—	—	—	—	unsigned char	13th and 14th characters of version		
0094	30149	—	—	—	—	unsigned char	1st and 2nd characters of type cord		
0096	30151	—	—	—	—	unsigned char	3rd and 4th characters of type cord		
0098	30153	—	—	—	—	unsigned char	5th and 6th characters of type cord		
009A	30155	—	—	—	—	unsigned char	7th and 8th characters of type cord		
009C	30157	—	—	—	—	int			write-in inhibit
~	~	—	—	—	—				write-in inhibit
10BE	34287	—	—	—	—	int			write-in inhibit
10C0	34289	2448	39289	2648	39801	float	Thermal flow		Unit: Heat flow rate unit
10C4	34293	244C	39293	264C	39805	float	Thermal flow (%)		%

Path 1 Channel 1		Path 2 Channel 2		Calculated value Channel 3		Data type	Parameter	Read-out data	Remarks
Relative address	Register No.	Relative address	Register No.	Relative address	Register No.				
10C8	34297	2450	39297	2650	39809	double	H: Total (thermal)		Unit: Total unit (thermal)
10D0	34305	2458	39305	2658	39817	double	C: Total (thermal)		Unit: Total unit (thermal)
10D8	34313	2460	39313	2660	39825	long	H: Total pulse (thermal)	No decimal point	Unit: Pulse
10DC	34317	2464	39317	2664	39829	long	C: Total pulse (thermal)	No decimal point	Unit: Pulse
10E0	34321	2468	39321	2668	39833	double	Supply flow temperature		Unit: Temperature unit
10E8	34329	2470	39329	2670	39841	double	Supply flow difference		Unit: Temperature unit
10F0	34337	2478	39337	2678	39849	double	Temperature difference		Unit: Temperature unit
10F8	34345	2480	39345	—	—	double			write-in inhibit
1100	34353	—	—	—	—	int			write-in inhibit
~	~	—	—	—	—				write-in inhibit
1114	34373	2488	39353	2680	39857	int			write-in inhibit

8. M-FLOW COMMUNICATION PROTOCOL

8.1 General

The communication system by the M-Flow protocol is that the communication is always started from the master station and a slave station responds to the received message.

Transmission procedures is as shown below.

- 1) The master station sends a command message to a slave station.
- 2) The slave station checks that the station No. in the received message matches with the own station No. or not.
- 3) If matched, the slave station executes the command and sends back the response message.
- 4) If mismatched, the slave station leaves the command message and wait for the next command message.

- a) In case when the station No. in the received command message matches with the own slave station No.

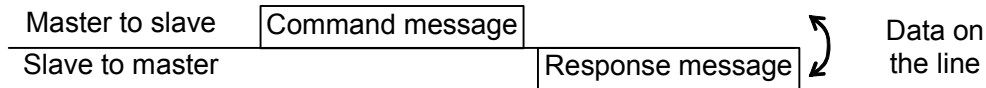

- b) In case when the station No. in the received command message mismatches with the own slave station No.

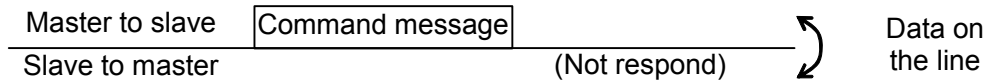

The master station can individually communicate with any one of slave stations connected on the same line upon setting the station No. in the command message.

8.2 Message Configuration

8.2.1 Reception

Description	Bytes	Remarks
Start mark	1	: (3Ah)
Slave address (SLV)	2	01 to 31
Function code (F_CD)	4	See function code table.
Error check	2	LRC
End mark	1	CR (0Dh)
	1	LF (0Ah)

8.2.2 Acknowledge

Description	Bytes	Remarks
Start mark	1	: (3Ah)
Slave address (SLV)	2	01 to 31
Function code (F_CD)	4	See function code table.
Data length (L)	2	
Data	2L	
Error check	2	LRC
End mark	1	CR (0Dh)
	1	LF (0Ah)

8.2.3 Error acknowledge

Description	Bytes	Remarks
Start mark	1	: (3Ah)
Slave address (SLV)	2	01 to 31
Function code (F_CD)	4	See function code table.
Error data	2	See error data table.
Error check	2	LRC
End mark	1	CR (0Dh)
	1	LF (0Ah)

Receive format : SLV F_CD LRC CR LF

Acknowledge format : SLV F_CD Data length Data LRC CR LF

Error acknowledge format : SLV F_CD Error data LRC CR LF

8.3 Error Check

Arrange the LRC so that the sum (carry not included) of all ASCII data excluding “:,” “CR” and “LF” will be 00h.

[LRC creation procedure]

- (1) Add the data headed by the start mark (:) excluding the carry.
- (2) Obtain 2's complement for the sum.
- (3) Convert the 2's complement into ASCII (= LRC).

8.4 Function Code Table

Content	F_cord	Remarks
Instantaneous velocity of flow (path 1)	0300	3 places after decimal point m/s[ft/s]
Instantaneous velocity of flow (path 2)	0301	3 places after decimal point m/s[ft/s]
Instantaneous velocity of flow (calculated value)	0302	3 places after decimal point m/s[ft/s]
Instantaneous flow rate (path 1)	0310	The decimal point conforms to that of Display 1. Flow rate unit.
Instantaneous flow rate (path 2)	0311	The decimal point conforms to that of Display 1. Flow rate unit.
Instantaneous flow rate (calculated value)	0312	The decimal point conforms to that of Display 1. Flow rate unit.
Total forward flow (path 1)	0320	The decimal point conforms to that of Display 1. Total flow unit.
Total forward flow (path 2)	0321	The decimal point conforms to that of Display 1. Total flow unit.
Total forward flow (calculated value)	0322	The decimal point conforms to that of Display 1. Total flow unit.
Total reverse flow (path 1)	0330	The decimal point conforms to that of Display 1. Total flow unit.
Total reverse flow (path 2)	0331	The decimal point conforms to that of Display 1. Total flow unit.
Total reverse flow (calculated value)	0332	The decimal point conforms to that of Display 1. Total flow unit.
Flow rate % (path 1)	0340	The decimal point conforms to that of Display 1.
Flow rate % (path 2)	0341	The decimal point conforms to that of Display 1.
Flow rate % (calculated value)	0342	The decimal point conforms to that of Display 1.
Instantaneous heat quantity (path 1)	0350	The decimal point conforms to that of Display 1. Heat unit.
Instantaneous heat quantity (path 2)	0351	The decimal point conforms to that of Display 1. Heat unit.
Instantaneous heat quantity (calculated value)	0352	The decimal point conforms to that of Display 1. Heat unit.
Total heat for heating (path 1)	0360	The decimal point conforms to that of Display 1. Total unit (thermal)
Total heat for heating (path 2)	0361	The decimal point conforms to that of Display 1. Total unit (thermal)
Total heat for heating (calculated value)	0362	The decimal point conforms to that of Display 1. Total unit (thermal)
Total heat value for cooling (path 1)	0370	The decimal point conforms to that of Display 1. Total unit (thermal)
Total heat value for cooling (path 2)	0371	The decimal point conforms to that of Display 1. Total unit (thermal)
Total heat value for cooling (calculated value)	0372	The decimal point conforms to that of Display 1. Total unit (thermal)
Heat quantity % (path 1)	0380	The decimal point conforms to that of Display 1.
Heat quantity % (path 2)	0381	The decimal point conforms to that of Display 1.
Heat quantity % (calculated value)	0382	The decimal point conforms to that of Display 1.
Supply flow temperature	0400	2 places after decimal point Temperature unit.
Return flow temperature	0410	2 places after decimal point Temperature unit.
Temperature difference	0420	2 places after decimal point Temperature unit.
Error information (Measurement line 1)	0100	16-bits
Error information (Measurement line 2)	0101	16-bits
Error information (Calculated value)	0102	16-bits

Note: If an error has occurred, the error acknowledge function code is as follows.

Function code: 0300 → 8300

8.5 Error Code Table

Error data	Remarks
01	Function code error (function code undefined)
02	LRC error
03	Reserve
04	Reserve
05	Reserve

9. PC LOADER SOFTWARE IN CD SUPPLIED WITH THE MAIN UNIT

9.1 Copyright of This Software

The copyright of this software belongs to Fuji Electric Co., Ltd. No part of this software may be reproduced or transmitted in any form.

9.2 Outline

Using this software, you can set, read and display relevant graphs of this instrument on your PC with ease. Your data can be easily edited with Microsoft Excel because you can save your data in CSV file format.

Note: Microsoft Excel is the registered Trademark of the Microsoft Corporation in the United States.

9.3 PC to Be Used

9.3.1 Computer

AT compatible-type with CPU Pentium IV 1 GHz/Celeron 1 GHz or more installed, display resolution of 1024 × 768, and use of small font recommended.

9.3.2 Memory capacity

128 MB or more (256 MB or more recommended) [52 MB memory or more for free space required]

9.3.3 Interface

RS232C port or RS485 port, MODBUS communication protocol

9.3.4 OS

Microsoft Windows2000 Professional (SP6a or more) or Microsoft WindowsXP Professional (SP1 or more) or Microsoft Windows7 (Home Premium, Professional)

9.4 Installing of Software

- (1) Insert the setup disk into the drive, and double-click “UltrasonicFlowmeter3_eng.msi.”

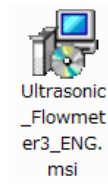

Fig. 9-1 <Install file>

- (2) Setting wizard will start up. Click the [Next] button. Click the [Cancel] button to cancel the installation.

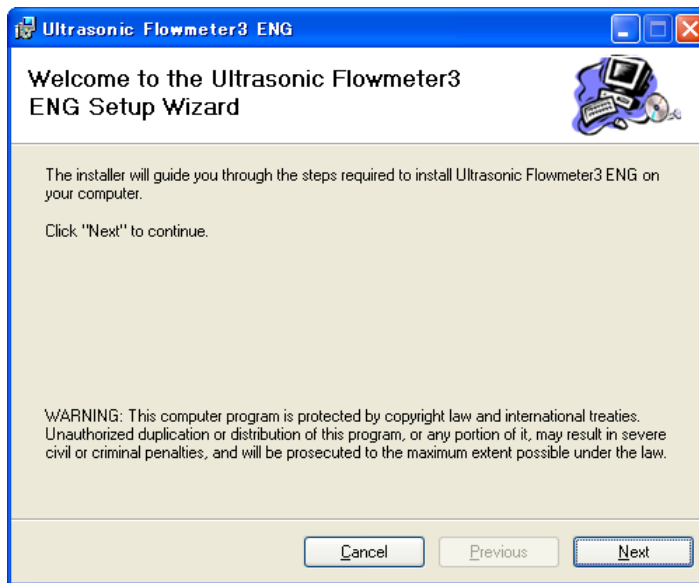

Fig. 9-2 < Setup wizard screen >

- (3) There is a query about selection of installation folder. Click the [Next] button to install the software in that folder. To specify a folder click the [Browse] button and select, or enter directly. To return to the previous screen, click the [Previous] button. Click the [Cancel] button to cancel the installation.

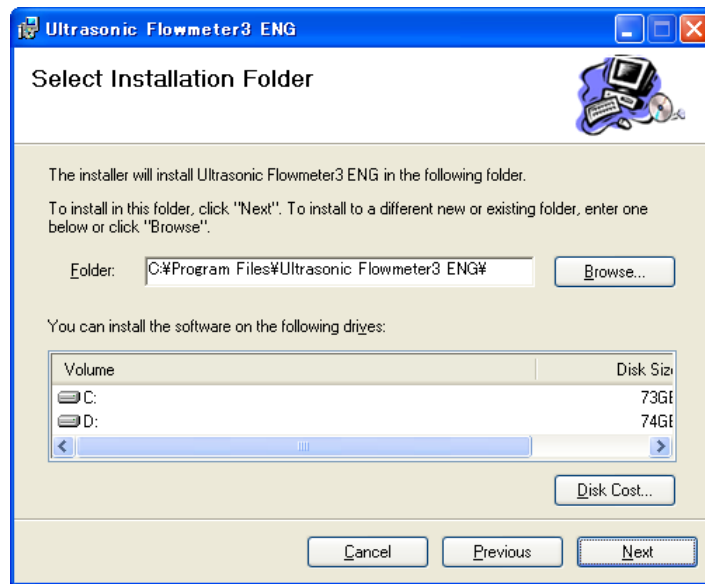

Fig. 9-3 < Select installation folder screen >

- (4) Screen is displayed to confirm installation. Click the [Next] button to execute the installation. Click the [Previous] button to return to the previous screen. Click the [Cancel] button to cancel the installation.

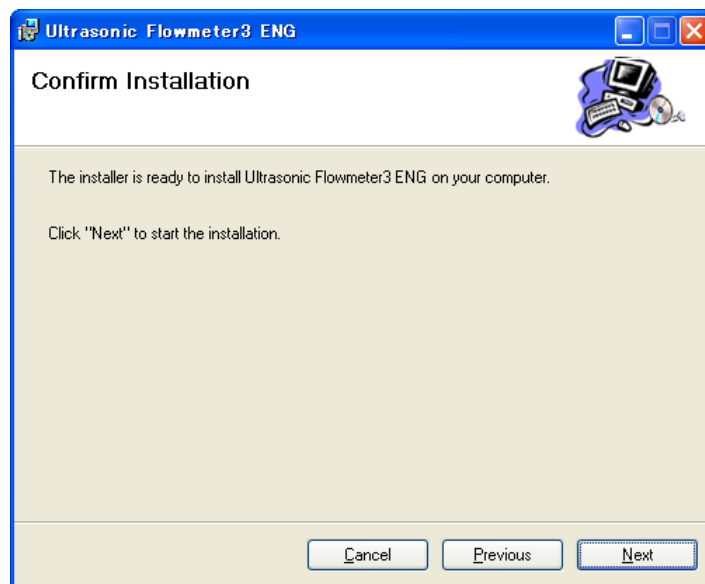

Fig. 9-4 < Installation confirmation screen >

(5) Execution of Installation

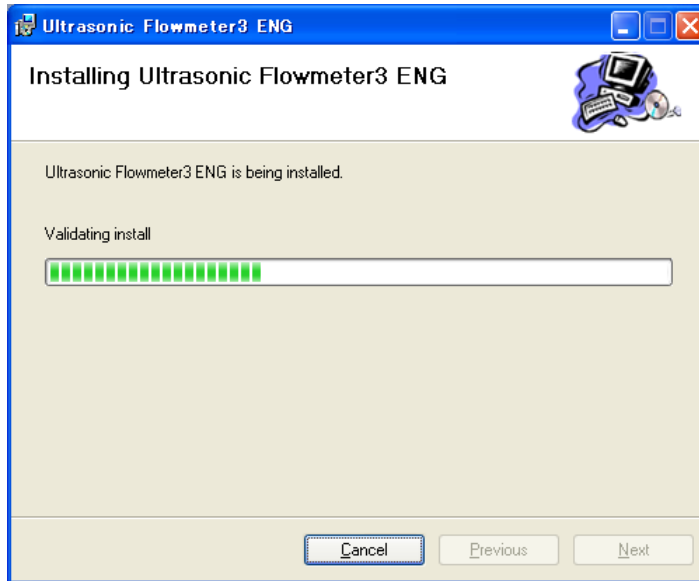

Fig. 9-5 < Installing screen >

(6) The Installation Complete screen is displayed. Click the [Close] button to exit the installation screen.

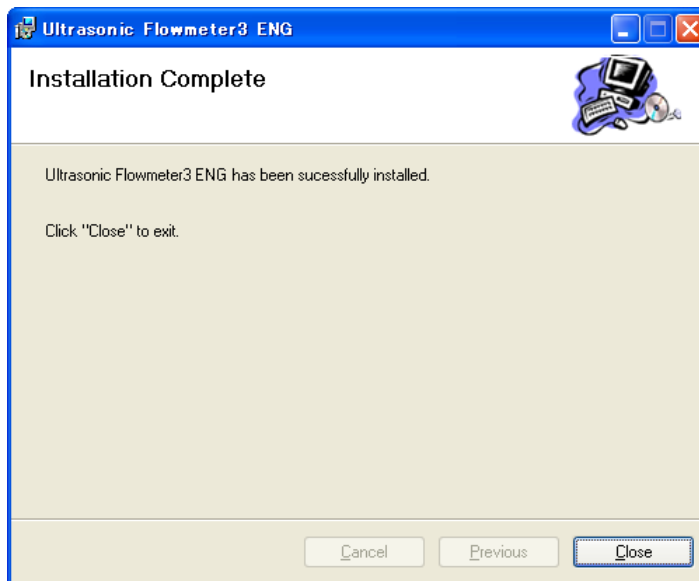

Fig. 9-6 < Installation complete screen >

(7) After installation, the start menu and the application (“Ultrasonic Flowmeter2”) that has been installed in the desktop are created.

9.5 Startup Method

Start “Ultrasonic Flowmeter2” from the start menu or the shortcut menu to start up the loader.



Fig. 9-7 < Start screen >

Information related to system name, measuring method, language and unit can be obtained by communicating with the flow transmitter.

If error occurs during communications, an error message is displayed to continue communication, select [Continue]. To stop communication, select [Cancel] on the menu screen that appears, check the setting for “Communication.”

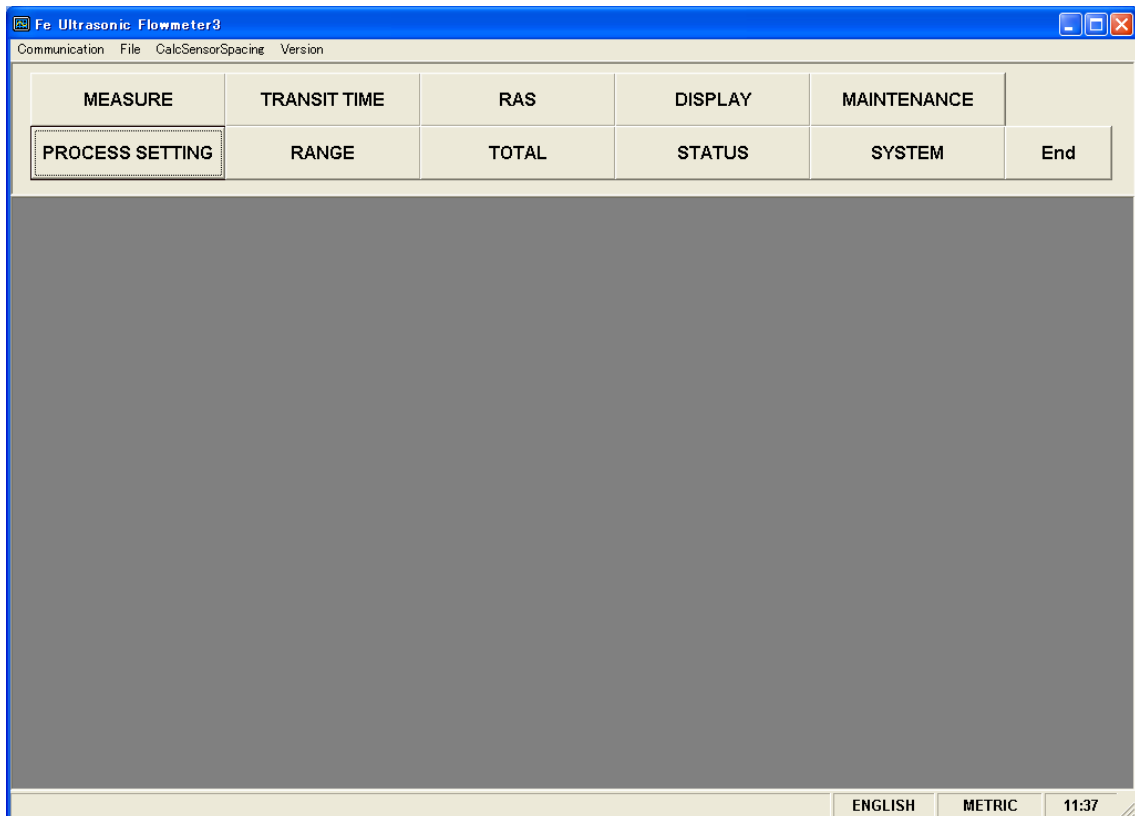

Fig. 9-8 < Menu screen >

Click the menu bar and each function button to execute a desired function.

Note: When communication cables are removed and then reconnected, restart the loader software.

9.5.1 Communications

Click “Communication” on the menu bar on the Menu screen, and the following setup screen appears.

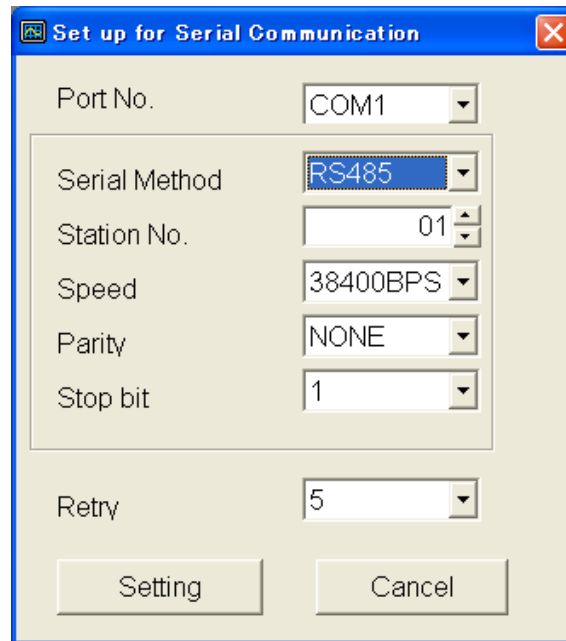

Fig. 9-9 < Serial communication setup screen >

Click the [Setting] button, and setting content is reflected; communications are executed with the flow transmitter and information related to system name, measurement method, language and unit is obtained. Click the [Cancel] button to invalidate the setting.

Table 9-1 <Measurement and Detailed Setting>

Item	Content
Port No.	Select either from COM1, COM2, COM3, COM4, COM5, COM6, COM7, COM8, COM9 and COM10.
Serial Method	Select RS485.
Station No.	Select one from 01 to 31. If communication method is RS232C, no selection is allowed (fixed with 00).
Speed	Select one from 9600BPS, 19200BPS and 38400BPS.
Parity	Select one from NONE, EVEN and ODD.
Stop Bit	Select either 1-bit or 2-bit.
Retry	Specify in the range from 0 to 5.

* Data transmitted from the transmission port for maintenance is formatted "RS232C/38400bps/None/1 bit."

9.5.2 Setting

Click “File” on the menu bar on the Menu screen, and either “Save” or “Open” can be selected.

9.5.2.1. Save setting

Click “Save”, and the following screen appears. Specify saving location and file name, and setting content is saved by clicking [Save] button. Click the [Cancel] button not to save the setting. File format is ini file.

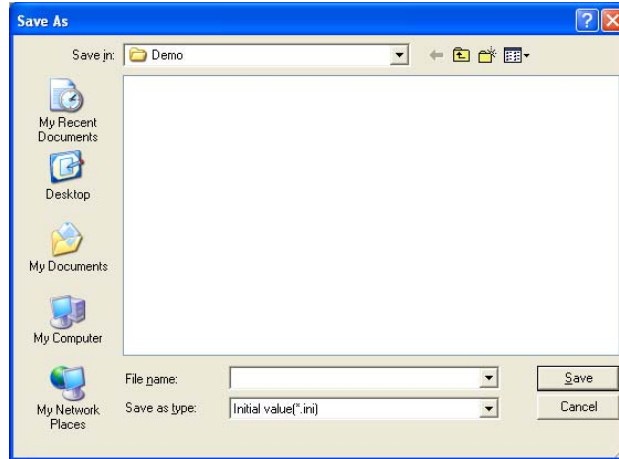

Fig. 9-10 < Save setting: select save file screen >

* Note: Please be careful not to rewrite the setting file for loader (Hybrid USF.ini).

9.5.2.2. Read setting

Click “Open”, and the following screen appears. Specify the location and the name of the file saved previously. Click the [Open] button to read the setting. Click the [Cancel] button not to read the setting. File format is ini file.

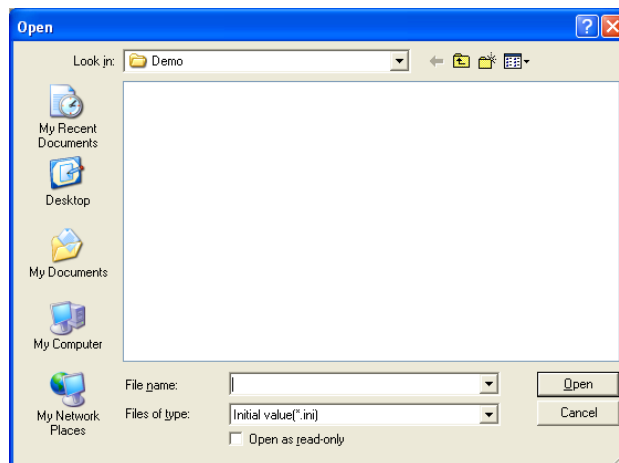

Fig. 9-11 < Read setting: select read file screen >

9.5.3 Calculation Sensor Spacing

On the menu screen, click [Calculation Sensor Spacing] of the menu bar, and the following screen appears. This function can be used even when connection with the main unit is not established for communication.

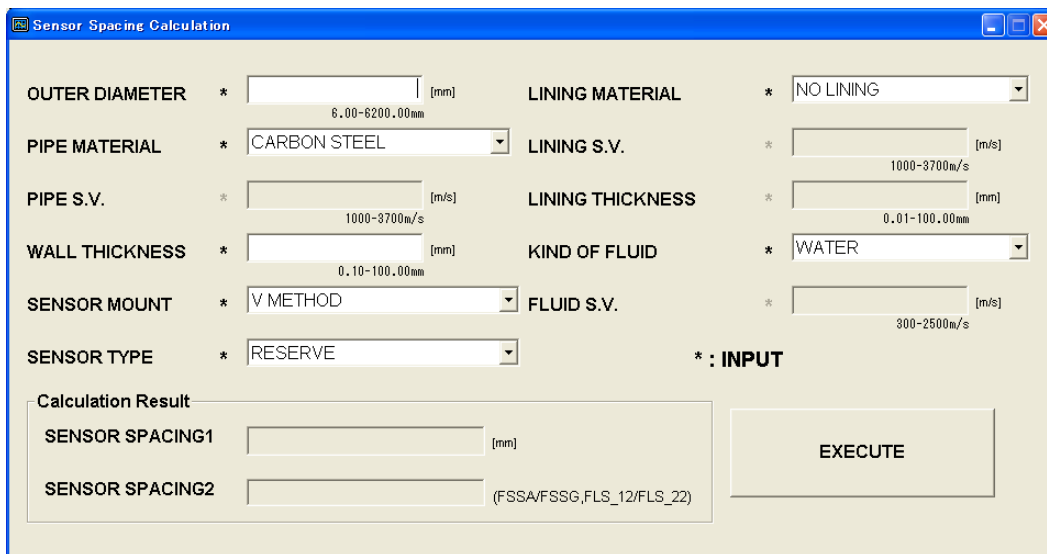

Fig. 9-12 < Calculation sensor spacing >

See Table 9-2 for details of calculation sensor spacing.

[Execute] button Calculates and displays sensor spacing 1 and 2 based on the input values.

Note: The values after the decimal point may differ from those of the main unit depending on the accuracy of calculation.

Table 9-2 < What to Enter >

Item	Content
OUTER DIAMETER	Enter in the range from 6.00 to 6200.00 mm (two decimal places) for metric system, and from 0.2362 to 244.1000 inch (four decimal places) for inch system.
PIPE MATERIAL	Select from carbon steel, stainless steel, PVC, copper, cast iron, aluminum, FRP, ductile iron, PEEK, PVDF, acrylic, PP, and pipe S.V.
PIPE SOUND VELOCITY	Enter in the range from 1000 to 3700 m/s (no decimal point) for metric system and from 3280 to 12140 ft/s (no decimal point) for inch system. (If "Pipe S.V." is selected as piping material.)
WALL THICKNESS	Enter in the range from 0.10 to 100.00 mm (two decimal places) for metric system, and from 0.0039 to 3.9380 inch (four decimal places) for inch system.
LINING MATERIAL	Select from no lining, tar epoxy, mortar, rubber, Teflon, pyrex glass, PVC and lining S.V.
LINING SOUND VELOCITY	Enter in the range from 1000 to 3700 m/s (no decimal point) for metric system, and from 3280 to 12140 ft/s (no decimal point) for inch system. (If "Lining S.V." is selected as lining material".)
LINING THICKNESS	Enter in the range from 0.01 to 100.00 mm (two decimal places) for metric system, and 0.0003 to 3.9380 inch (four decimal places) for inch system. (If "No lining" is selected as lining material.)
KIND OF FLUID	Select for water, seawater, dist. water, ammonia, alcohol, benzene, bromide, ethanol, glycol, kerosene, milk, methanol, toluene, lube oil, fuel oil, petrol, coolant R410, and fluid S.V.
FLUID S.V.	Enter in the range from 300 to 2500 m/s (no decimal point) for metric system, and from 984 to 8203 ft/s (no decimal point) for inch system. (If "Fluid S.V." is selected as fluid type").
SENSOR MOUNT	Select from V method and Z method.
SENSOR TYPE	Select from FSSA/FSSG, FLS_12/FLS_22, FSSC, FSG_32, FSG_31/FSG_41, FSSE/FSG_50, FSSF/FSG_51, FSD12, FSSD/FSD22, FSSH/FSD32
SENSOR SPACING 1	Displays the calculation result of sensor spacing 1.
SENSOR SPACING 2	Displays the calculation result of sensor spacing 2. (If FLS_12, FLS_22, FSSA or FSSG is selected as sensor type.)

9.5.4 Version

Click “Version” on the menu bar on the Menu screen, and the following screen appears.

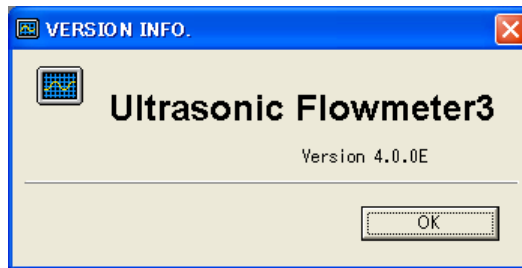

* The version number at left is a display example.

Fig. 9-13 < Version screen >

Click the [OK] button to close the screen.

9.6 Measurement mode setting procedure

9.6.1 2-pipe measurement

Mode to measure 2-pipe simultaneously

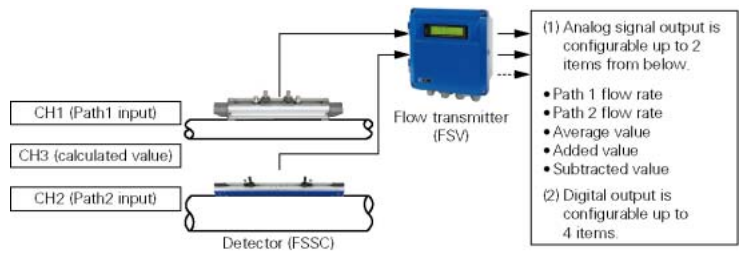

- Procedure 1 General setting
- Set language, unit, and ID No.
 - Read version
 - Select operation mode
- Measurement setting
- Set measurement mode "2-pipe."
 - Select arithmetic expression of CH3.
- Set the AO output source
- Select measured values of CH1 to CH3 output to AO1 and AO2

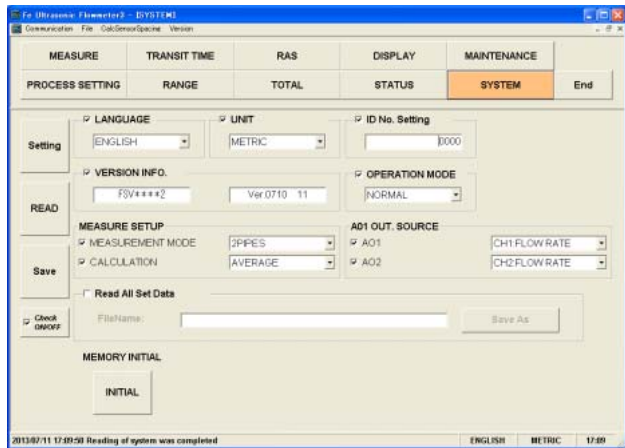

- Procedure 2 Set CH1 and CH2 piping specifications
- Set a piping specification for measurement
 - Set a fluid for measurement.
- Set CH1 and CH2 sensors
- Set a sensor mounting method.
 - Set a sensor type.

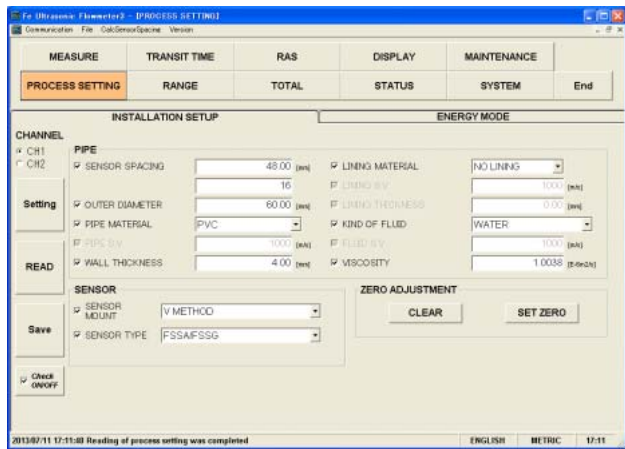

- Procedure 3 Set CH1 to CH3 ranges
- Select Measurement range, Unit, and Type
 - Set Flow Full Scale, Hysteresis, Burn-out, Output, and Rate limit.

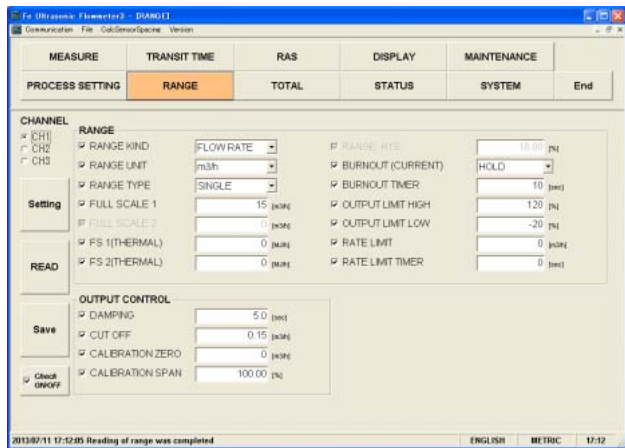

- Set CH1 and CH2 control outputs
- Set Damping, Low flow cutting, and Output correction

- Procedure 4 Set integration of CH1 to CH3.
- Set mode
 - Set Total flow, Pulse width, and Burn-out.

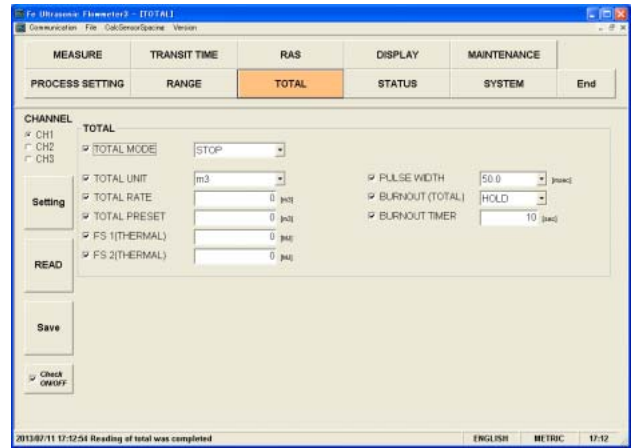

- Procedure 5 Set DO1 to DO4 status output.
- Select a channel and set an output type.
 - Set contact operation.

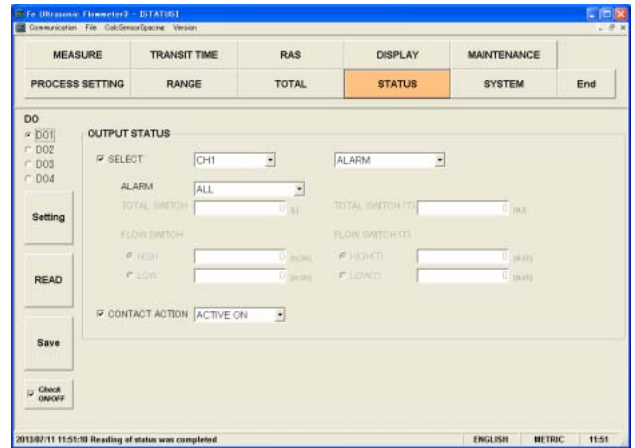

- Procedure 6 Converter display setting
- Set channel, display type, and decimal point to be displayed on Display 1.
 - Set channel, display type, and decimal point to be displayed on Display 2.
 - Set backlight.

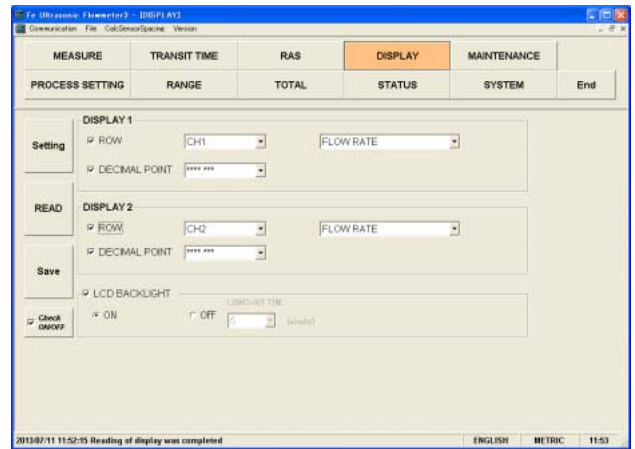

9.6.2 2-path measurement (for 1 pipe)

Mode to measure 1-pipe with 2-path

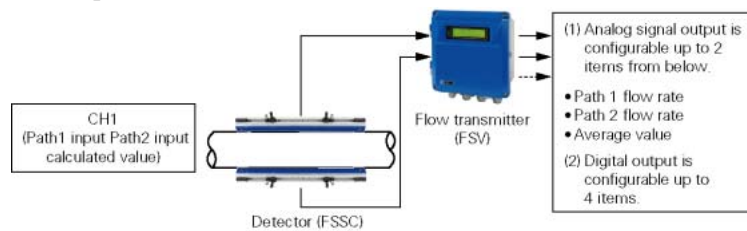

Procedure 1

General setting

- Set language, unit, and ID No.
 - Read version
 - Select operation mode
- #### Measurement setting
- Set measurement mode "2-path."
- #### Set the AO output source
- Select measured values output to AO1 and AO2.

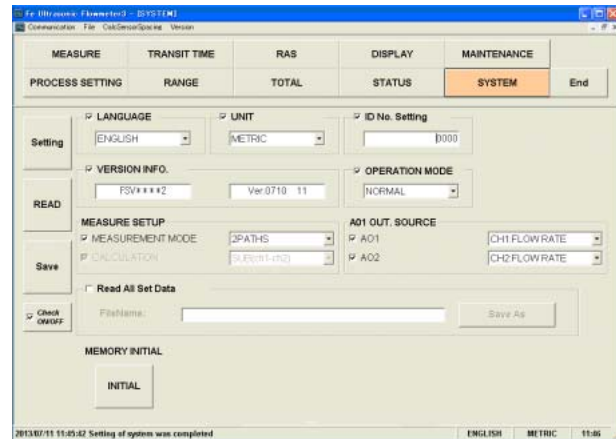

Procedure 2

Set CH1 piping specification.

- Set a piping specification for measurement.
 - Set a fluid for measurement.
- #### Set CH1 sensor.
- Set a sensor mounting method.
 - Set a sensor type.

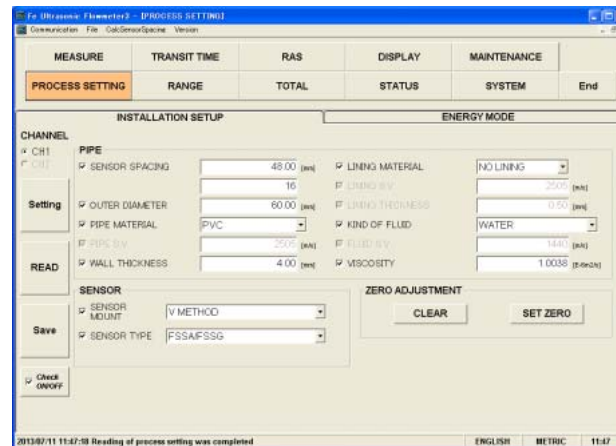

Procedure 3

Set CH1 range.

- Select Measurement range, Unit, and Type.
- Set Flow Full Scale, Hysteresis, Burn-out, Output, and Rate limit.

Set CH1 control output.

- Set Damping, Low flow cutting, and Output correction.

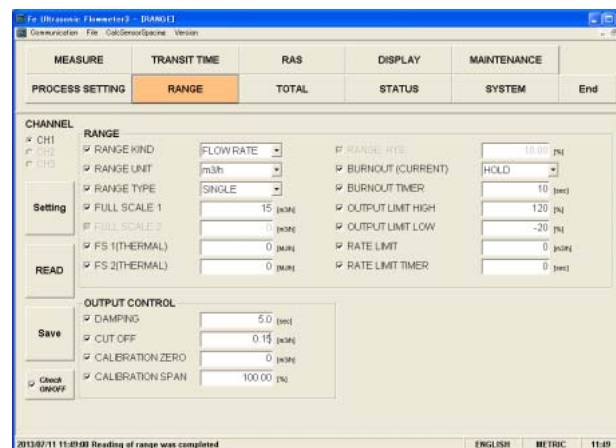

- Procedure 4 Set CH1 integration.
- Set mode
 - Set Total flow, Pulse width, and Burn-out.

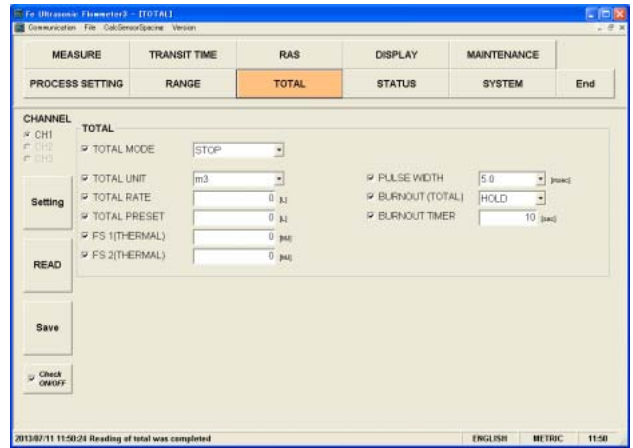

- Procedure 5 Set DO1 to DO4 status output.
- Select a channel and set an output type.
 - Set contact operation.

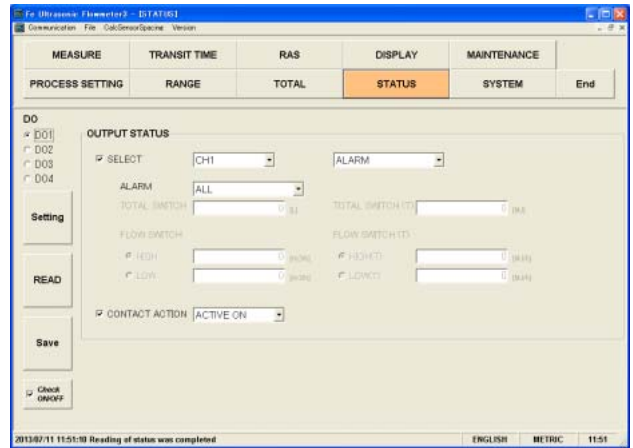

- Procedure 6 Converter display setting
- Set channel, display type, and decimal point to be displayed on Display 1.
 - Set channel, display type, and decimal point to be displayed on Display 2.
 - Set backlight.

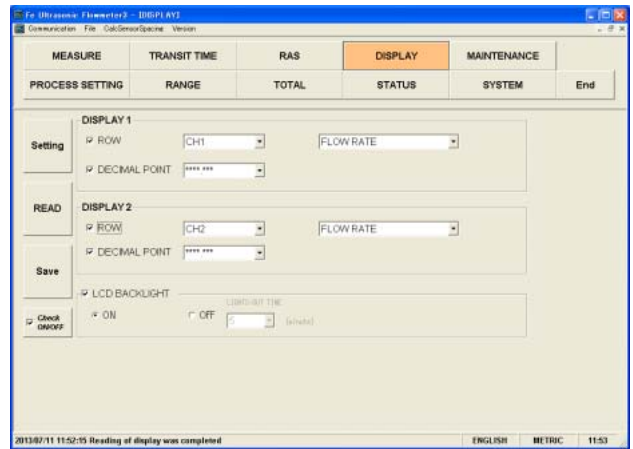

9.6.3 Consumed energy calculation function

Mode to measure heat quantity by using a connected platinum thermometer.

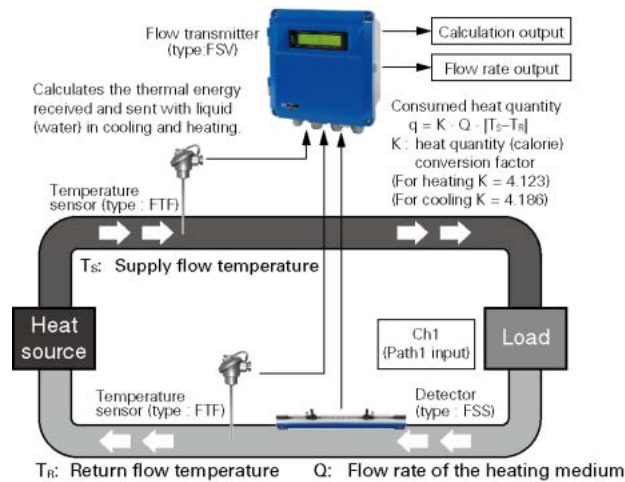

Procedure 1

General setting

- Set language, unit, and ID No.
- Read version
- Select operation mode

Measurement setting

- Set measurement mode "1-path."

Set the AO output source

- Select measured values (flow rate or thermal energy) output to AO1 and AO2.

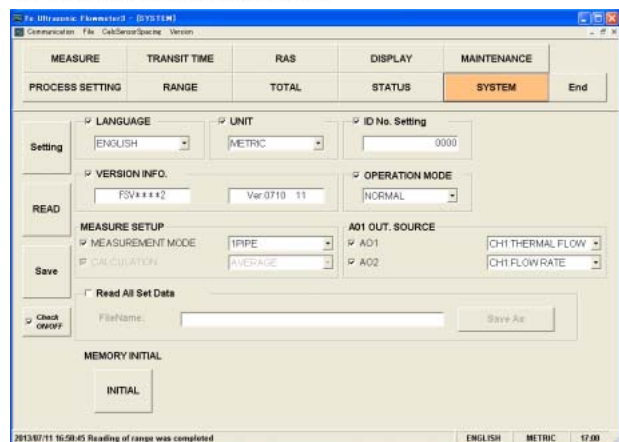

Procedure 2

Installation Set

Set CH1 piping specification.

- Set a piping specification for measurement.
- Set a fluid for measurement.

Set CH1 sensor.

- Set a sensor mounting method.
- Set a sensor type.

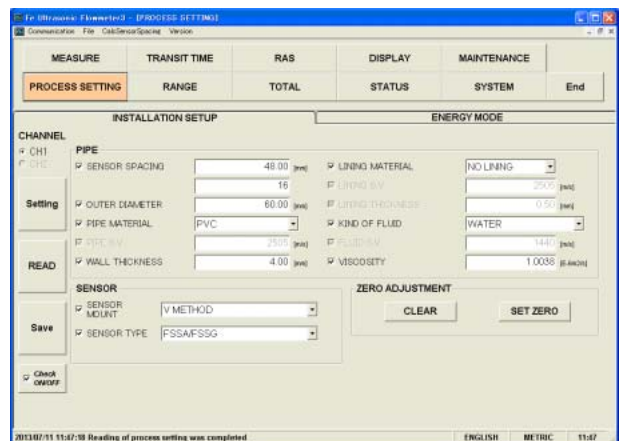

Energy mode

Unit setting

- Set units for temperature, thermal flow, and total thermal energy.

Setting of the Energy mode

- Select Energy mode
- Select operation and set heat quantity.

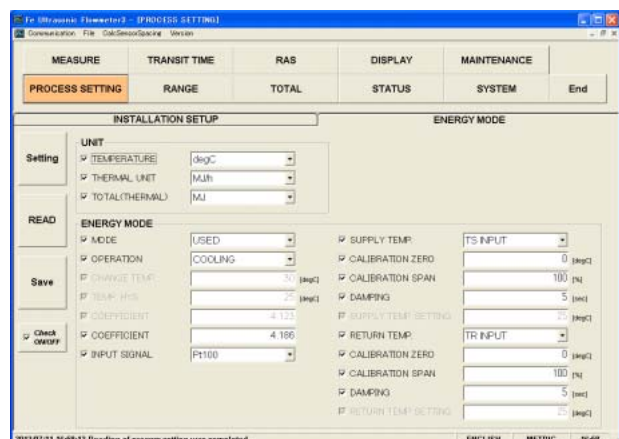

- Procedure 3 Set CH1 range.
- Select Measurement range, Unit, and Type.
 - Set Flow Full Scale, Full Scale (thermal) Hysteresis, Burn-out, Output, and Rate limit.
- Set CH1 control output.
- Set Damping, Low flow cutting, and Output correction.

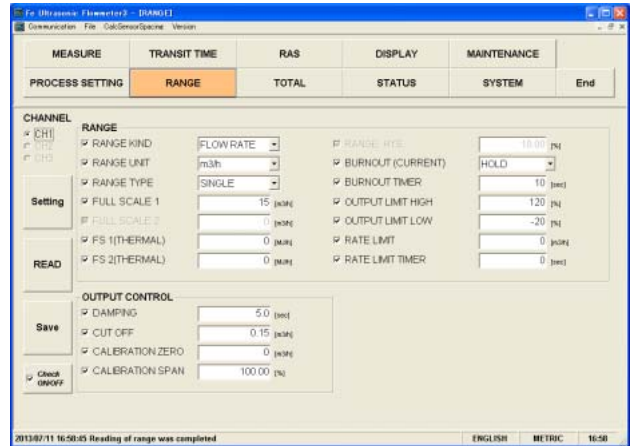

- Procedure 4 Set CH1 integration.
- Set mode
 - Set Total flow, Total thermal energy, Pulse width, and Burn-out.

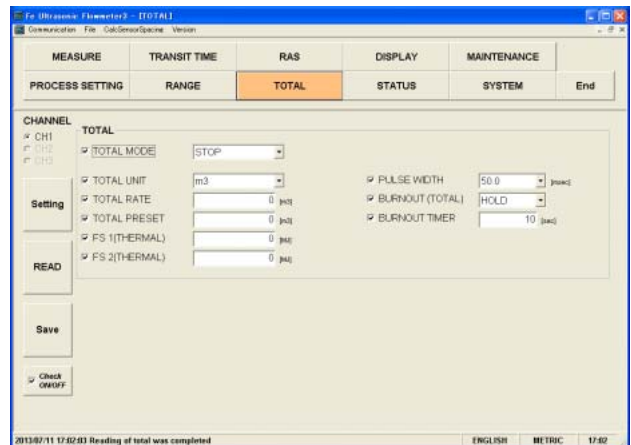

- Procedure 5 Set DO1 to DO4 status output.
- Select a channel and set an output type.
 - Set contact operation.

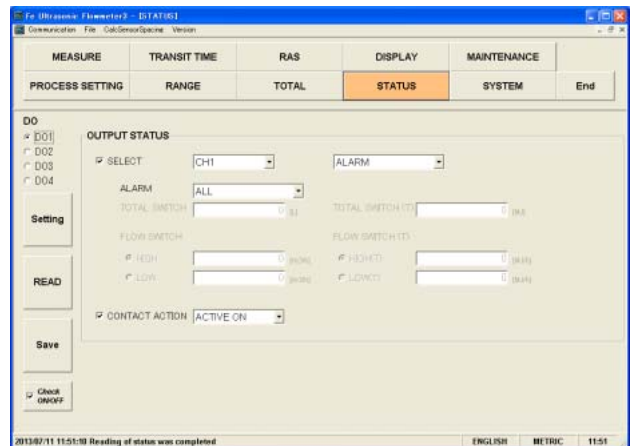

- Procedure 6 Converter display setting
- Set channel, display type, and decimal point to be displayed on Display 1.
 - Set channel, display type, and decimal point to be displayed on Display 2.
 - Set backlight.

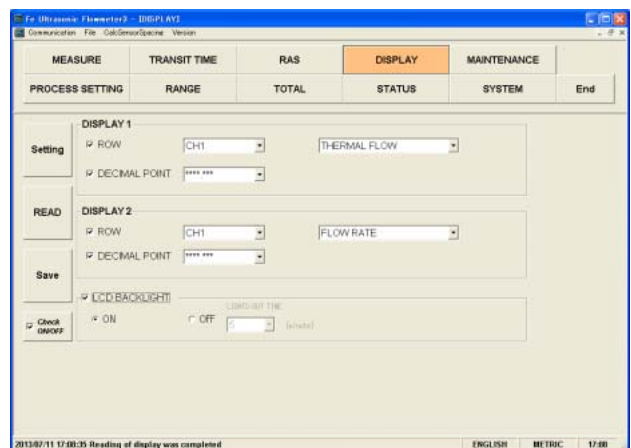

9.7 Structure of Function

Functions with loader are as follows:

Table 9-3 < Function >

Function	Outline
PROCESS	Sets piping specifications, sensor type, etc.
RANGE	Sets range-related matters. Sets for heat quantity measurement.
TOTAL	Sets total-related matters.
STATUS	Sets status output-related matters.
DISPLAY	Sets LCD display-related matters.
SYSTEM	Sets system related to language, etc.
MEASURE	Displays trend of flow rate, etc.
TRANSIT TIME	Displays graphs on detailed setting of transit time difference, operation information and received waveform, etc.
RAS	Read-in RAS.
MAINTENANCE	Conducts AO adjustment and AO/DO test.
PV	Measures station No. 1 to No. 31. Available only when RS485 communication.

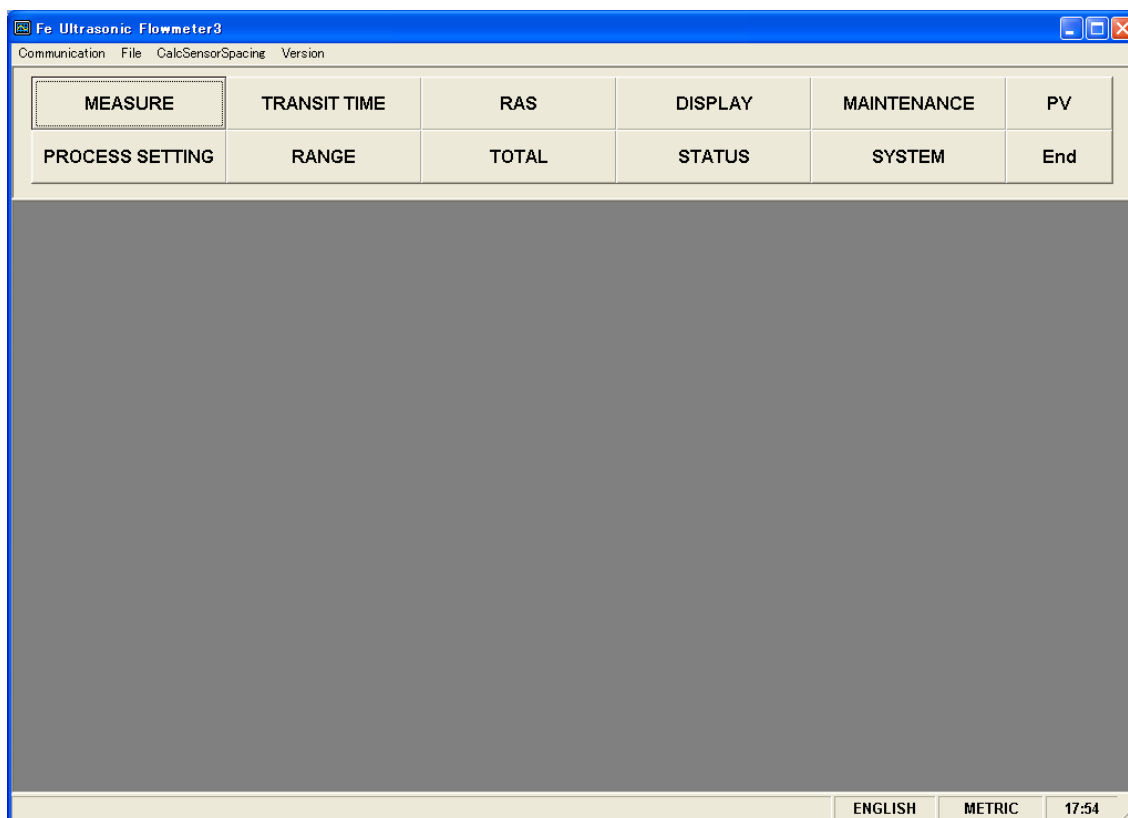

Fig. 9-14 < Menu screen >

9.8 System Setting

Click the “SYSTEM” button on the Menu screen, and the following screen appears.

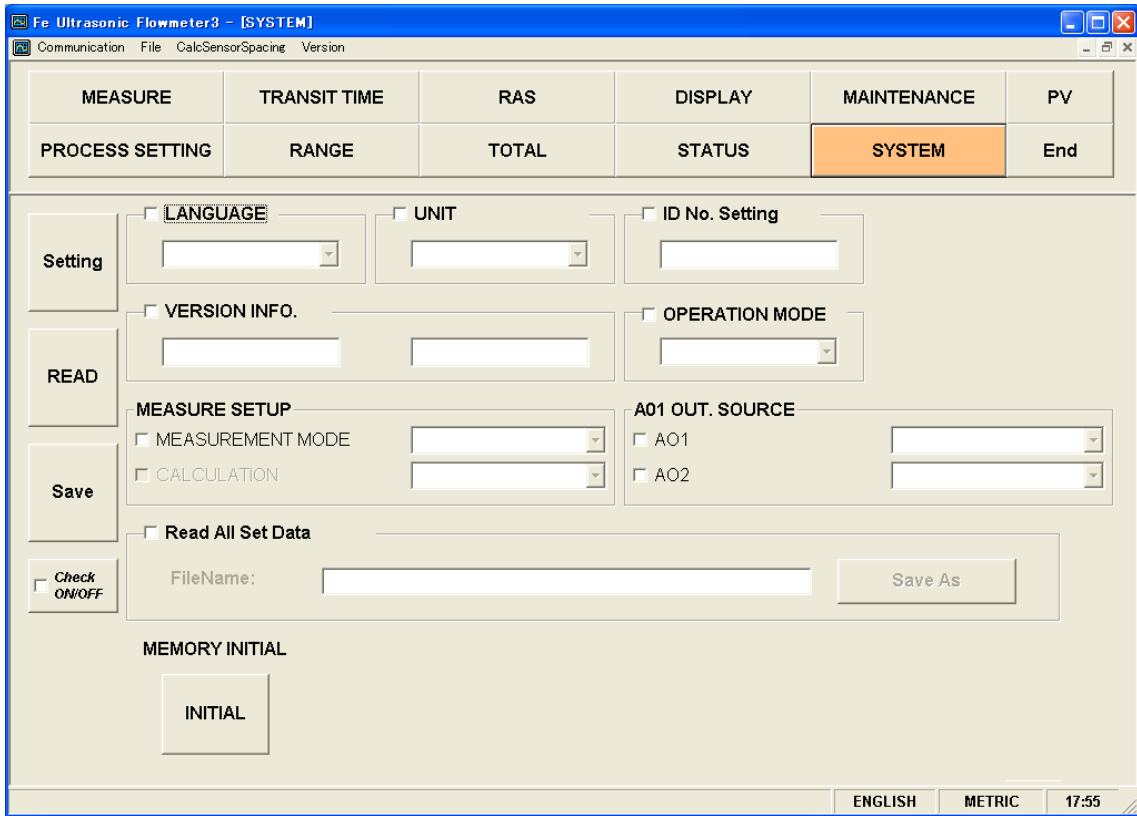

Fig. 9-15 < System setting screen >

To select an item to be set or read, set the relevant check box to ON (☑). Not to select (or to reset the selection), set the relevant check box to OFF (☐). However, system name and version information can only be read. For details of “System setting,” refer to Table 9-4.

- [Setting]Sends the setting of the selected item (check box set to ON (☑)), reflecting the response value on the setting.
- [READ]Reads the setting of the selected item (check box set to ON (☑)), reflecting the response value on the setting.
- [Save]Reflects the setting sent by pressing the [Setting] button on the flow transmitter. Be sure to press the [Save] button if the setting is changed.
- [Check ON/OFF]Set the check box to ON (☑) to select all the items (to set all the check boxes to ON (☑)). Set the check box to OFF (☐) to release the selection of all the items (to set all the check boxes to OFF (☐)). * Note that the Read-in All Set Data check box cannot be checked (☑ not allowed).
- [INITIAL] buttonReturns all the settings of the flowmeter to the initial state.

Table 9-4 < System Setting >

Item	Content
LANGUAGE	Language is available in ENGLISH, JAPANESE, GERMAN, FRENCH and SPANISH.
UNIT SYSTEM	Select from METRIC and ENGLISH.
ID No. Setting	Enter in rage of 0000 to 9999.
Version information	Read only
Operation mode	Select Standard or High speed.
Measurement mode	Select 1-path, 2-path, or 2-pipe
CH3 operation output	Measurement mode valid when "2-pipe" is selected Select from a group of Average, Added value, Difference (CH1 - CH2), and Difference (CH2 - CH1).
AO output source	Select CH1 flow, CH2 flow, CH3 flow, or CH1 heat for each of AO1 and AO2. Selected items are dependent upon the measurement mode. 1path: CH1: Flow, CH1 Heat 2path, 2channel: CH1: Flow rate, CH2: Flow rate, CH3: Flow rate
Read All set Data	Outputs all the setting of the flowmeter to a designated file in CSV format. [Select Save File] Click this button, set a location and file to which all setting data is saved, and click the [READ] button. All setting that has been made is saved in the specified file.

9.9 Process Setting

[Installation Set] and [Heat mode] are displayed when you press the [Process setting] button on the "Menu" screen.

9.9.1 Installation Set

Displayed when you select the [Installation Set] tab of the "Process setting" screen.

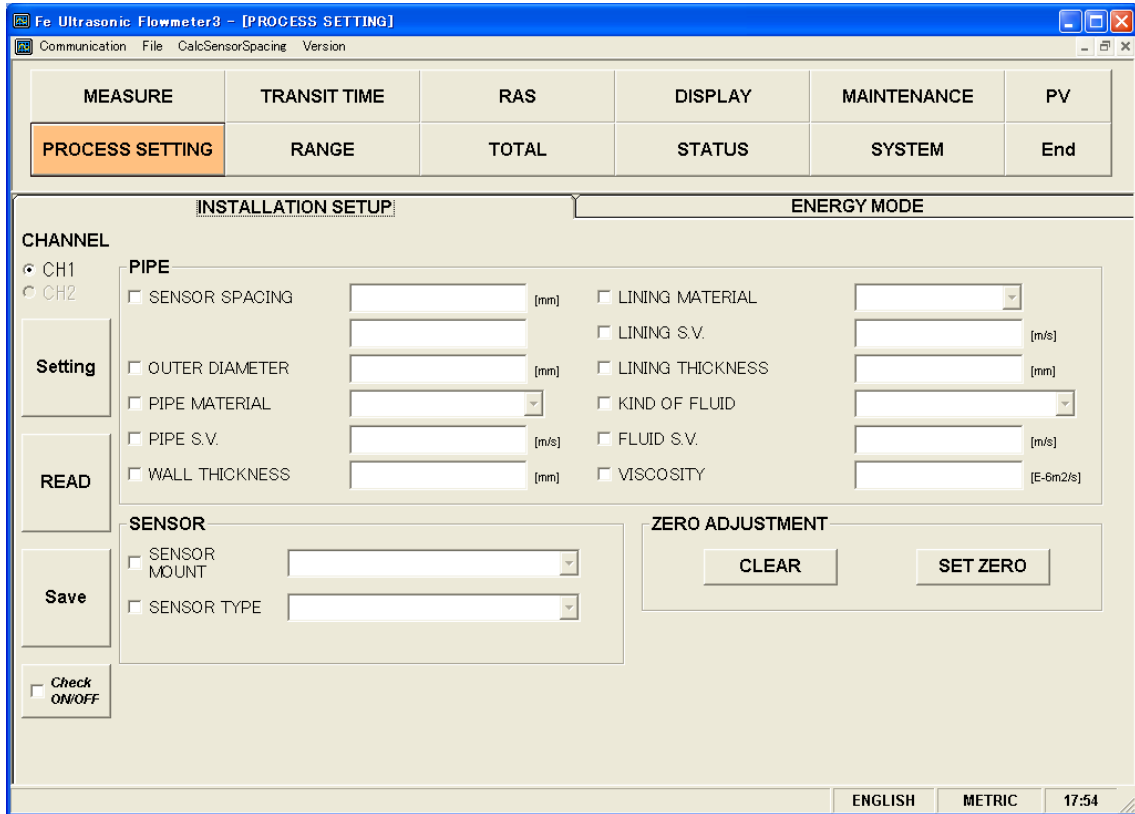

Fig. 9-16 < Installation setting screen >

To select an item to be set or read, set the relevant check box to ON (☑). Not to select (or to reset the selection), set the relevant check box to OFF (☐). If "Other" is selected as pipe material, pipe sound velocity becomes valid. For details of "Process setting," refer to Tables 9-4 and 5 on the next page.

- Pipe material: Items other than PIPE S.V.
Display invalid..... PIPE S.V.
- Pipe material: PIPE S.V.
Display valid..... PIPE S.V.
- Lining material: Without lining
Display invalid..... LINING S.V., LINING THICKNESS
- Lining material: Without lining, Items other than LINING S.V.
Display valid..... LINING THICKNESS
Display invalid..... LINING S.V.
- Lining material: LINING S.V.
Display valid..... LINING S.V., LINING THICKNESS
- Kind of fluid: For items other than FLUID S.V.
Display invalid..... FLUID S.V.
- Kind of fluid: FLUID S.V.
Display valid..... FLUID S.V.

- [Setting]..... Sends the setting of the selected item (check box set to ON ()), reflecting the response value on the setting.
- [READ] Reads the setting of the selected item (check box set to ON ()), reflecting the response value on the setting.
- [Save] Reflects the setting sent by pressing the [Setting] button on the flow transmitter. Be sure to press the [Save] button if the setting is changed.
- [Check ON/OFF]..... Set the check box to ON to select all the items (to set all the check boxes to ON ()). Set the check box to OFF () to release the selection of all the items (to set all the check boxes to OFF ()).
- [Channel Select] Set or read the piping specification and sensors of the selected channel and calibrate zero-point.
When "1-pipe" ("1-path or "2-path") is selected, CH2 display is disabled.
Setting of CH1 and CH2 are enabled only when "2-pipe" are selected.
- [Zero adjustment].....
- [CLEAR]..... Clears zero calibration.
- [SET ZERO]..... Executes zero calibration adjustment.

Table 9-5 < Piping Specifications >

Item	Content
OUTER DIAMETER	Enter in the range from 6.00 to 6200.00 mm (two decimal places) for metric system, and from 0.2362 to 244.1000 inch (four decimal places) for inch system.
PIPE MATERIAL	Select from carbon steel, stainless steel, PVC, copper, cast iron, aluminum, FRP, ductile iron, PEEK, PVDF, acrylic, PP, and pipe S.V.
PIPE SOUND VELOCITY	Enter in the range from 1000 to 3700 m/s (no decimal point) for metric system and from 3280 to 12140 ft/s (no decimal point) for inch system. (If "Pipe S.V." is selected as piping material.)
WALL THICKNESS	Enter in the range from 0.10 to 100.00 mm (two decimal places) for metric system, and from 0.0039 to 3.9380 inch (four decimal places) for inch system.
LINING MATERIAL	Select from no lining, tar epoxy, mortar, rubber, Teflon, pyrex glass, PVC and lining S.V.
LINING SOUND VELOCITY	Enter in the range from 1000 to 3700 m/s (no decimal point) for metric system, and from 3280 to 12140 ft/s (no decimal point) for inch system. (If "Lining S.V." is selected as lining material".)
LINING THICKNESS	Enter in the range from 0.01 to 100.00 mm (two decimal places) for metric system, and 0.0003 to 3.9380 inch (four decimal places) for inch system. (If "No lining" is selected as lining material.)
KIND OF FLUID	Select for water, seawater, dist. water, ammonia, alcohol, benzene, bromide, ethanol, glycol, kerosene, milk, methanol, toluene, lube oil, fuel oil, petrol, coolant R410, and fluid S.V.
FLUID S.V.	Enter in the range from 300 to 2500 m/s (no decimal point) for metric system, and from 984 to 8203 ft/s (no decimal point) for inch system. (If "Fluid S.V." is selected as fluid type").
VISCOSITY	Enter in the range from 0.001 to 999.999 E-6 m ² /s for metric system, and from 0.0107 to 10764 E-6 ft ² /s for inch system.
SENSOR SPACING	[Read] only is valid.

Table 9-6 < System >

Item	Content
SENSOR MOUNT	Select from Z method and V method.
SENSOR TYPE	Select from FSSA/FSSG, FLS_12/FLS_22, FSSC, FSG_32, FSG_31/FSG_41, FSSE/FSG_50, FSSF/FSG_51, FSD12, FSSD/FSD22, FSSH/FSD32

9.9.2 Energy mode

Displayed when you select the [Energy mode] tab of the "Process setting" screen.

Setting of the Energy mode is required for measurement of thermal energy consumption.

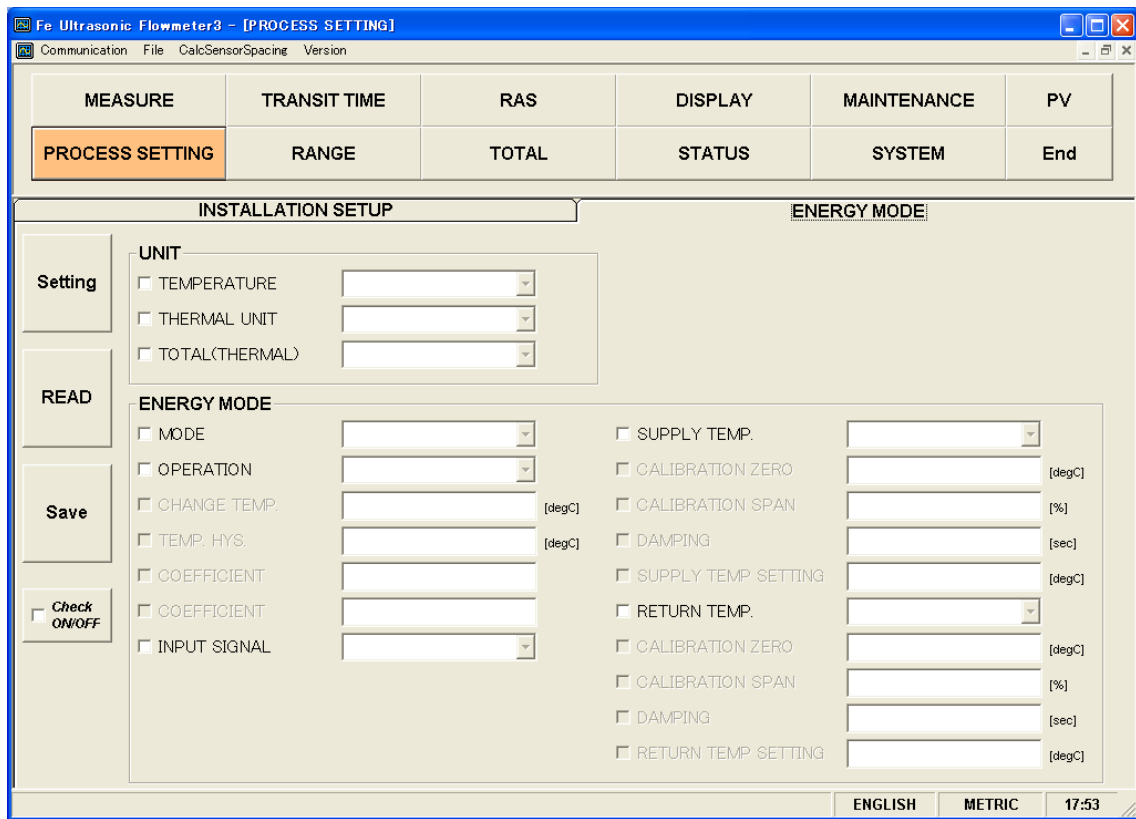

Fig. 9-17 "Energy mode screen"

Select items you want to set and read by checking their check boxes (""). Clear ("") the check-box of an item when you do not want to select the item (or you want to unselect it).

For details of the Energy mode, see Table 9-5 to Table 9-6 on the next page.

- When "Cooling operation" is selected
Display enabled Thermal coefficient for coefficient.
- When "Heating operation" is selected
Display enabled Thermal coefficient for heating
- When "Cooling operation" is selected
Display enabled Switching temperature and hysteresis
- Supply flow temperature: For a TS temperature input,
Display enabled Supply flow temperature calibration zero, Supply flow temperature calibration span, and Supply flow Damping
- Supply flow temperature: For a TS temperature setting
Display enabled Supply flow temperature setting
- Return flow temperature: For a TR temperature input,
Display enabled Return flow temperature calibration zero, Return flow temperature calibration span, Return flow Damping
- Return flow temperature: For a TR temperature setting
Display enabled Return flow temperature setting

T Table 9-9 "Unit"

Item	Content
Temperature	Select ° C, K, or F.
Heat flow rate	Select from MJ/h, GJ/h, BTU/h, kBTU/h, MBTU/h, kWh, MWh.
Total heat flow	Select from MJ, GJ, BTU, kBTU, MBTU, kW, MW.

Table 9-10 "Energy mode"

Item	Content
Mode	Select from Used, Not used.
Operation	Select Cooling, Heating, or Air-conditioning.
Switching temperature	Enter a value in the range of -40 to 200° C (for a heating & cooling operation).
Hysteresis	Enter a value in the range of -40 to 200° C (for a heating & cooling operation).
Thermal coefficient for heating	Enter a value in the range of 1.000 to 9.999 (Thermal coefficient in heating operation)
Thermal coefficient for cooling	Enter a value in the range of 1.000 to 9.999 (Thermal coefficient in cooling operation)
Supply flow temperature	Select "TS temperature input" or "Temperature setting."
Supply flow temperature calibration zero	Enter a value in the range of -40 to 40° C (for a TS temperature input).
Supply flow temperature calibration span	Enter a value in the range of 50 to 150 % (for a TS temperature input).
Supply flow damping	Enter a value in the range of 0 to 120sec (for a TS temperature input).
Supply flow temperature setting	Enter (for temperature setting).
Return flow temperature	Select "TR temperature input" or "Temperature setting."
Return flow temperature calibration zero	Enter a value in the range of -40 to 40° C (for a TR temperature input).
Return flow temperature calibration span	Enter a value in the range of 50 to 150 % (for a TR temperature input).
Return flow damping	Enter a value in the range of 0 to 120sec (for a TR temperature input).
Return flow temperature setting	Enter (for temperature setting).
Temperature input signal	Select "Not use" or "Pt100."

[SET] button..... Sends the setting of selected items (whose check-box has a check mark (“☑”)) and reflects the returned response values.

[SET] button..... Sends the setting of selected items (whose check-box has a check mark (“☑”)) and reflects the returned response values.

[SAVE] button..... Reflects the setting data sent by the [SET] button on the flow meter converter. This is always required when the setting is changed.

[Check ON/OFF] check button When this check-box is clicked (“☑”), all items are selected. (The check-box of every item has a check mark (“☑”). When the check-box is cleared (“☐”), all items are unselected (where the check-box of every item is cleared (“☐”).

9.10 Range Setting

Click the “RANGE” button on the Menu screen, and the following screen appears.

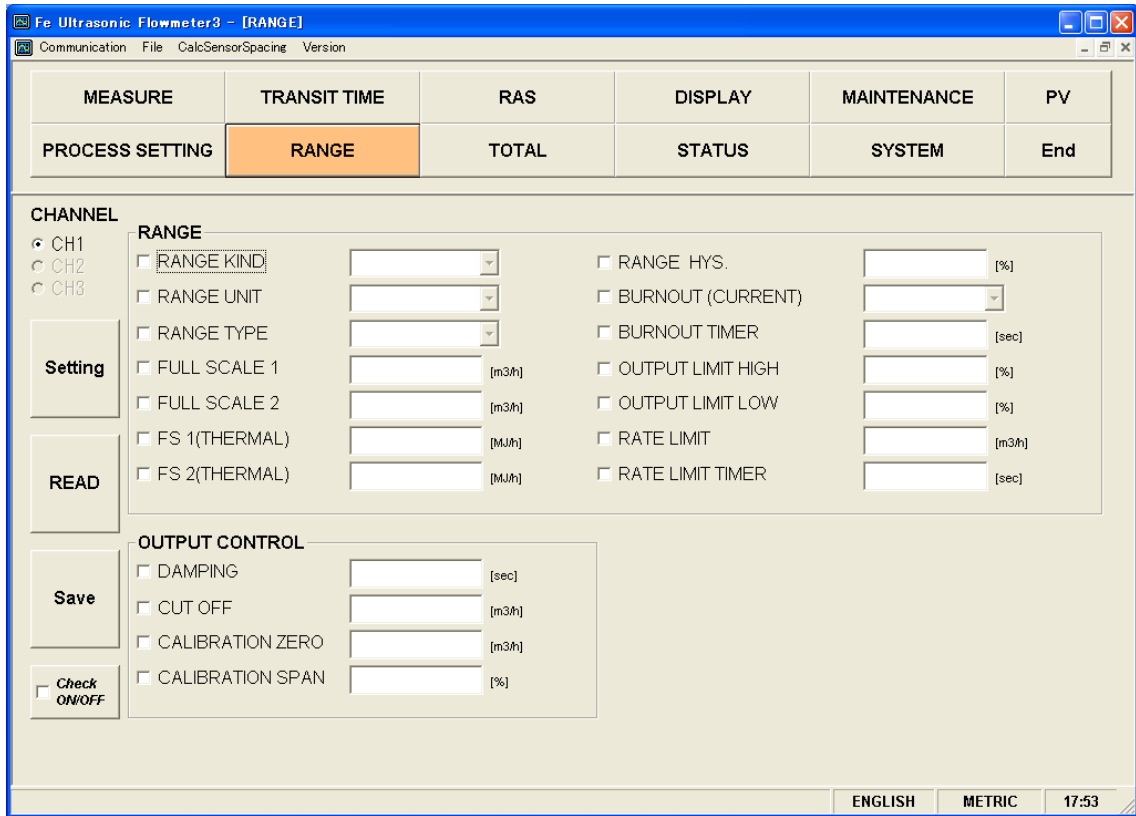

Fig. 9-18 < Range setting screen >

To select an item to be set or read, set the relevant check box to ON (☑). Not to select (or to reset the selection), set the relevant check box to OFF (☐). For details of “Range setting,” refer to Tables 9-6 to 9-10 on the next page.

- Type: in the case of single range;
 - Display Valid..... Full scale 1
 - Display Invalid..... Full scale 2 and hysteresis
 - Type: in the case of automatic 2-range, Bi-directional range, Bi-directional automatic 2-range
 - Display Valid..... Full scale 1, full scale 2 and hysteresis
 - Display Invalid..... None
- [Channel Select]Sets the range of a selected channel, controls outputs, and sets/reads temperature inputs.
 Not interlocked with the AO output source
 When "1-pipe" ("1-path or "2-path") is selected, CH2 and CH3 displays are disabled.
 Setting of CH1,CH2, and CH3 are enabled only when "2-pipe" is selected.
- [Setting]Sends the setting of the selected item (check box set to ON (☑)), reflecting the response value on the setting.
- [READ]Reads the setting of the selected item (check box set to ON (☑)), reflecting the response value on the setting.
- [Save]Reflects the setting sent by pressing the [Setting] button on the flow transmitter. Be sure to press the [Save] button if the setting is changed.
- [Check ON/OFF]Set the check box to ON to select all the items (to set all the check boxes to ON (☑)). Set the check box to OFF (☐) to release the selection of all the items (to set all the check boxes to OFF (☐)).

Table 9-11 < Range Setting >

Item	Content
KIND	Velocity, Flow rate *”Flow rate” only is available to CH3.
RANGE UNIT	Select from L/s, L/min, L/h, L/d, kL/d, ML/d, m3/s, m3/min, m3/h, m3/d, k m33/d, M m3/d, BBL/s, BBL/min, BBL/h, BBL/d, kBBL/d, MBBL/d [ft3/s, ft3/min, ft3/h, ft3/d, kft/d, Mft3/d, gal/s, gal/min, gal/h, gal/d, kgal/d, Mgal/d, BBL/s, BBL/min, BBL/h, BBL/d, kBBL/d, MBBL/d]* Of which []: unit is in case of inch system.
RANGE TYPE	Select from SINGLE, AUTO 2, BI-DIR, BI-DIR AUTO 2.
Full scale 1	Enter in.
Full scale 2	Enter in.
Full Scale 1 (thermal)	Enter in.
Full Scale 2 (thermal)	Enter in.
HYSTERISIS	Enter in the range of 0.00 to 20.00%. (2 places after decimal point)
OUTPUT LIMIT LOW	Enter in the range of -20 to 0%.
OUTPUT LIMIT HIGH	Enter in the range of 100 to 120%.
BURNOUT (current)	Select from NOT USED, HOLD, UPPER, LOWER, ZERO.
BURNOUT TIMER	Enter in the range of 0 to 900sec.
RATE LIMIT	Enter 0 to 5 m/s fitting value (comply with range unit).
RATE LIMIT TIMER	Enter in the range of 0 to 900 sec.

Table 9-7 < Output control >

Item	Content
DAMPING	Enter in the range of 0.0 to 100.0 sec. (1 place after decimal point)
CUT OFF	Enter 0 to 5 m/s fitting value (comply with range unit).
ZERO	Enter -5 to 5 m/s fitting value (comply with range unit).
SPAN	Enter in the range of $\pm 200.00\%$. (2 places after decimal point)

9.11 Total Setting

Click the “TOTAL” button on the Menu screen, and the following screen appears.

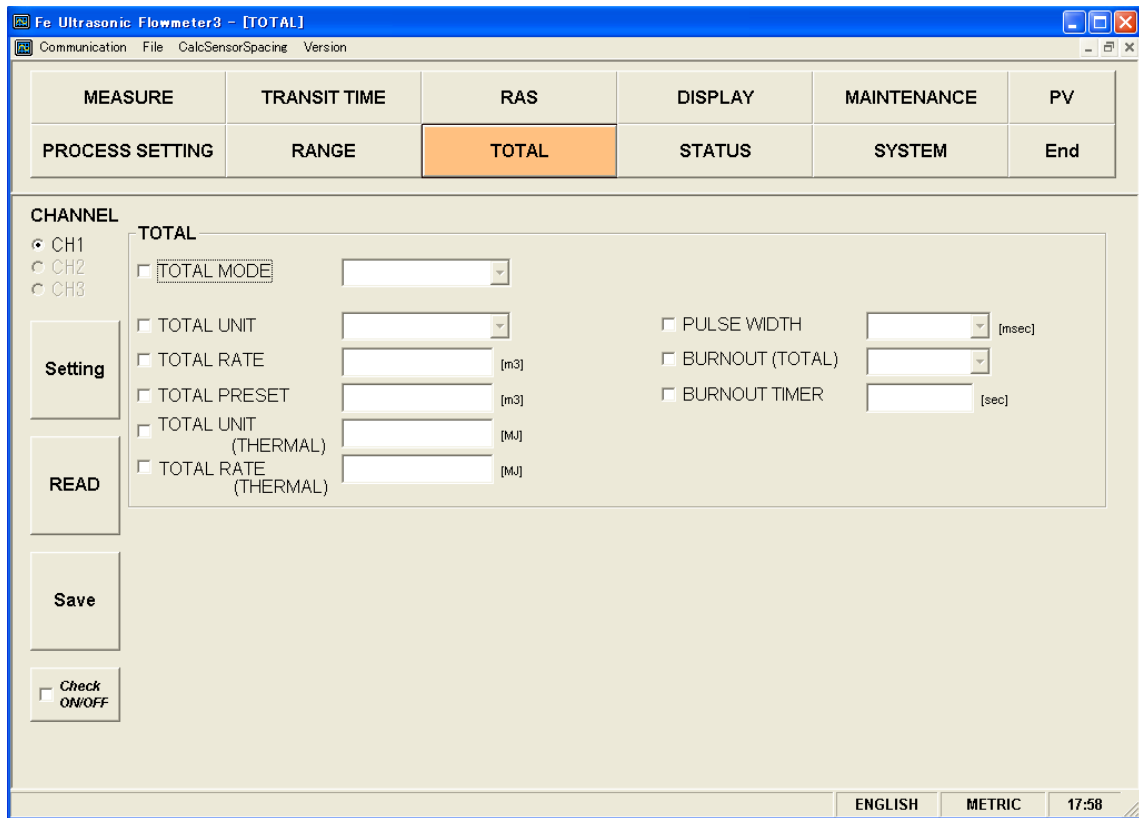

Fig. 9-19 < Total setting screen >

To select an item to be set or read, set the relevant check box to ON (☑). Not to select (or to reset the selection), set the relevant check box to OFF (☐). For details of “Total setting,” refer to Table 9-8 on the next page.

- Mode: in case of start and reset;
Display invalid..... Unit, constant, total preset, pulse width
- Mode: in case of stop;
Display valid..... Unit, constant, total preset, pulse width
- Channel Select.....Set or read the total data of the selected channel.
When "1-pipe" ("1-path or "2-path") is selected, CH2 and CH3 displays are disabled.
Setting of CH1,CH2, and CH3 are enabled only when "2-pipe" is selected.

[Setting].....Sends the setting of the selected item (check box set to ON (☑)), reflecting the response value on the setting. Note that only when “STOP” mode is selected, the setting of unit, constant, total preset, pulse width is reflected.

[READ]Reads the setting of the selected item (check box set to ON (☑)), reflecting the response value together with the unit on the setting.

[Save]Reflects the setting sent by pressing the [Setting] button on the flowmeter flow transmitter.
Be sure to press the [Save] button if the setting is changed.

[Check ON/OFF].....Set the check box to ON (☑) to select all the items (to set all the check boxes to ON (☑)). Set the check box to OFF (☐) to release the selection of all the items (to set all the check boxes to OFF (☐)).

Table 9-8 < Total Setting >

Item	Content
TOTAL MODE	Select from TOTAL STOP, TOTAL RUN, TOTAL RESET.
TOTAL UNIT	Select from mL, L, m ³ , km ³ , Mm ³ , mBBL, BBL and kBBL, [ft ³ , kft ³ , Mft ³ , kgal, gal, mBBL, BBL, kBBL and ACRf]* Of which []: unit is in case of inch system.
Total rate	Enter in the range of 0 to 99999999 fitting value. (comply with flow rate total unit)
Total preset	Enter in the range of 0 to 99999999 fitting value. (comply with flow rate total unit)
Total rate (thermal)	Enter in the range of 0 to 99999999 fitting value. (conforming to the total heat unit)
Total preset (thermal)	Enter in the range of 0 to 99999999 fitting value. (conforming to the total heat unit)
PLUSE WIDTH	Select from 5.0, 10.0, 50.0, 100.0, 200.0, 500.0, 1000.0 msec
BURNOUT (total)	Select from NOT USED and HOLD.
BURNOUT TIMER	Enter in the range of 0 to 900 sec.

Note: When unit is changed, each unit indication of constant and total preset is changed if [Read] is executed.

Note: When setting of the unit, rate, total preset, and pulse width is changed, it should be executed with the mode stop.

9.12 Status Output Setting

Click the “STATUS” button on the Menu screen, and the following screen appears.
 Allocate contact output terminals DO1 to DO4 (to set and read status output).

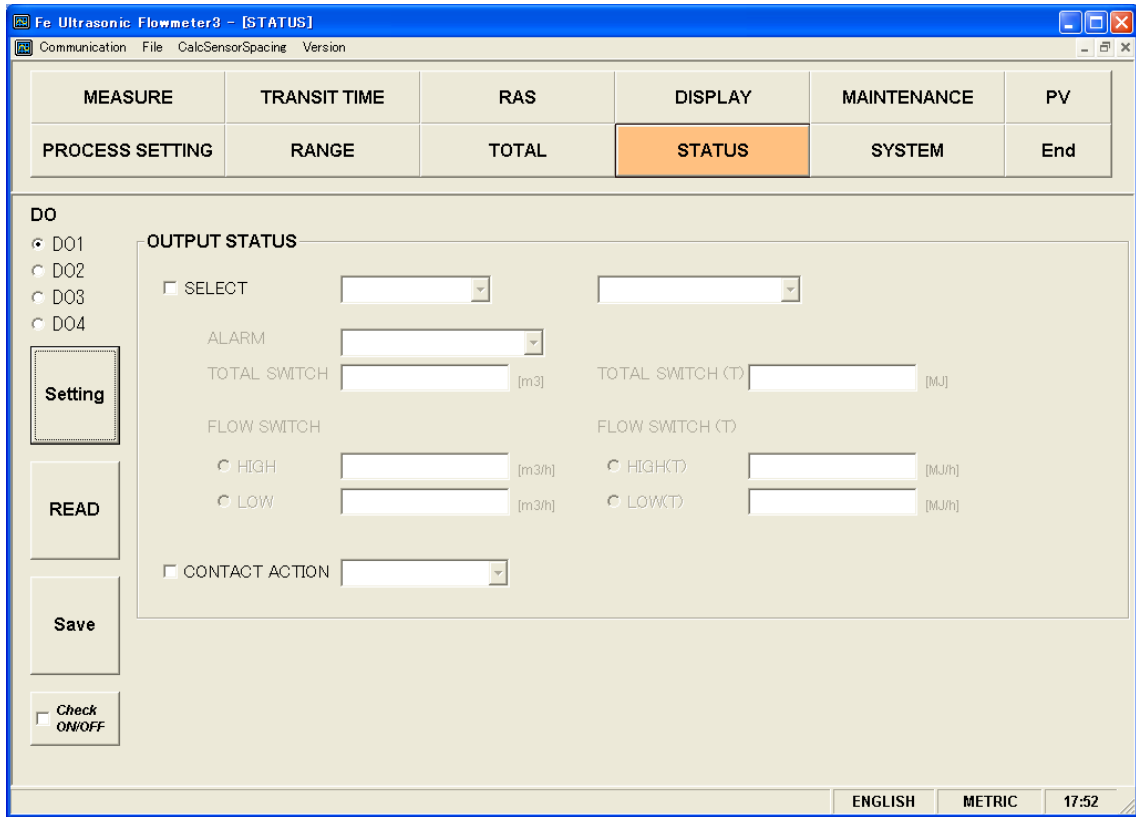

Fig. 9-20 < Status output setting screen >

To select an item to be set or read, set the relevant check box to ON (☑). Not to select (or to reset the selection), set the relevant check box to OFF (☐). For details of “Status output setting,” refer to Tables 9-12 and 9-13 on the next page.

- Status output: output excluding Alarm, Flow switch, Total switch, Flow switch (T), and Total switch (T)
 Display disabledAlarm, Flow switch (Flow SW high and Flow SW low), Total flow switch, Flow switch (T)
 (Flow SW high (T) and Flow SW low (T)), Total switch (T)
- Status output: output of Alarm
 Display enabledAlarm
 Display disabledFlow switch (Flow SW high and Flow SW low), Total flow switch, Flow switch (T)
 (Flow SW high (T) and Flow SW low (T)), Total switch (T)
- Status output: In the case of Flow switch
 Display enabledFlow switch (Flow SW high and Flow SW low)
 Display disabledAlarm, Total flow switch, Flow switch (T) (Flow SW high (T) and Flow SW low (T)), Total
 switch (T)
- Status output: In the case of Total switch
 Display enabledTotal flow switch
 Display disabledAlarm, Flow switch (Flow SW high and Flow SW low), Flow switch (T) (Flow SW high (T)
 and Flow SW low (T)), Total switch (T)

• Status output: In the case of Flow switch (T)

Display enabled..... Flow switch (T) (Flow SW high (T) and Flow SW low (T))

Display disabled..... Alarm, Flow switch (Flow SW high and Flow SW low), Total flow switch, Total switch (T)

• Status output: In the case of Total switch (T)

Display enabled..... Total switch (T)

Display disabled..... Alarm, Flow switch (Flow SW high and Flow SW low), Total flow switch, Flow switch (T)
(Flow SW high (T) and Flow SW low (T))

DO Select Sets or reads status output of the selected DO number.

[Setting]..... Sends the setting of the selected item (check box set to ON ()), reflecting the response value on the setting.

[READ]..... Reads the setting of the selected item (check box set to ON ()), reflecting the response value on the setting.

[Save]..... Reflects the setting sent by pressing the [Setting] button on the flow transmitter. Be sure to press the [Save] button if the setting is changed.

[Check ON/OFF]..... Set the check box to ON to select all the items (to set all the check boxes to ON ()). Set the check box to OFF () to release the selection of all the items (to set all the check boxes to OFF ()).

Table 9-9 < Status output setting >

Item	Content		
DO1	Select from CH1, CH2, CH3. 1-path: For CH1 only		
	Select from a group of Not use, +Total pulse, -Total pulse, Full scale 2, Alarm, Flow switch, Total switch, Ao range-over, Pulse range-over, -Flow direction, Total heat pulse for heating, Total heat pulse for cooling, Full scale 2 (T), Flow switch (T), Total switch (T), AO range-over (T), Pulse range-over (T), Air-conditioning, and temperature alarm.		
	Alarm	Select from All, Hardware error, and Process error (when alarm is selected for DO1 output).	
	Flow switch	Select from Upper flow rate limit (Flow switch High) and Lower flow rate limit (Flow switch Low) (when flow rate switch is selected for DO1 output).	
		Flow switch High	Enter in the range from 0 to 32 m/s or equivalent. (Use the same unit as the range unit.)
		Flow switch Low	Enter in the range from 0 to 32 m/s or equivalent. (Use the same unit as the range unit.)
	Total switch	Enter in the range from 0 to 99999999. (Use the same unit as the total unit.)	
	Flow switch (thermal)	Select "Flow SW light" or "Flow SW low" (When the DO1 output is "Flow switch (T)")	
		Flow SW light (T)	Enter in. (conforming to the heat unit)
		Flow SW low (T)	Enter in. (conforming to the heat unit)
Total switch (thermal)	Enter in the range of 0 to 99999999 fitting value. (conforming to the integration unit) (When the DO1 output is "Total switch (T)")		
DO2	Select from CH1, CH2, CH3. 1-path: For CH1 only		
	Same as DO1 selection		
DO3	Select from CH1, CH2, CH3. 1-path: For CH1 only		
	Same as DO1 selection		
DO4	Select from CH1, CH2, CH3. 1-path: For CH1 only		
	Same as DO1 selection		
DO1 contact operation	Select ON at operation or OFF at operation.		
DO2 contact operation	Ditto		
DO3 contact operation	Ditto		
DO4 contact operation	Ditto		

9.13 Display Setting

Click the “DISPLAY” button on the Menu screen, and the following screen appears.

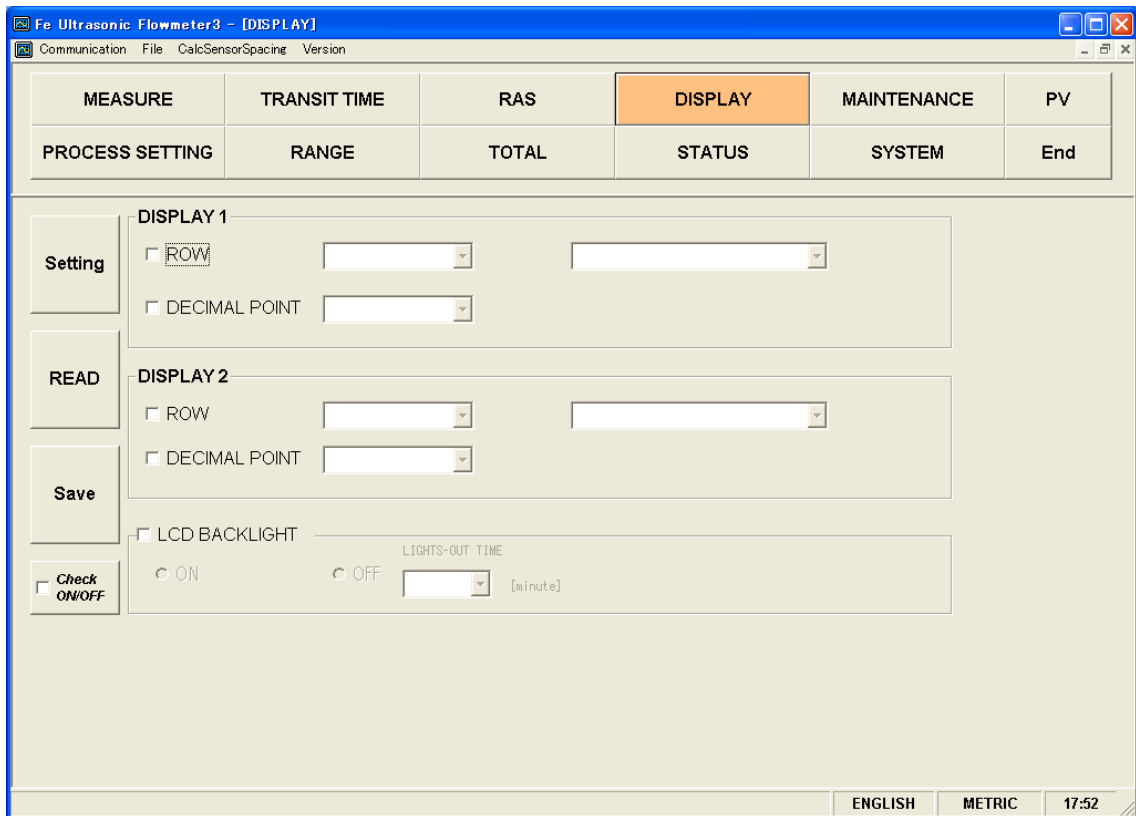

Fig. 9-21 < Display setting screen >

To select an item to be set or read, set the relevant check box to ON (☑). Not to select (or to reset the selection), set the relevant check box to OFF (☐). For details of “Display setting,” refer to Table 9-10.

- Display 1, 2 selection: In the case of Velocity of flow, +Total pulse, -Total pulse, Heat total pulse for heating, Heat total pulse for cooling, feeding fluid temperature, returning fluid temperature, and temperature difference
Display invalid..... Decimal point

[Setting].....Sends the setting of the selected item (check box set to ON (☑)), reflecting the response value on the setting.

[READ]Reads the setting of the selected item (check box set to ON (☑)), reflecting the response value on the setting.

[Save]Reflects the setting sent by pressing the [Setting] button on the flowmeter flow transmitter.
Be sure to press the [Save] button if the setting is changed.

[Check ON/OFF].....Set the check box to ON to select all the items (to set all the check boxes to ON (☑)). Set the check box to OFF (☐) to release the selection of all the items (to set all the check boxes to OFF (☐)).

Table 9-10 < Display Setting >

Item		Content
DISPLAY 1	Selection	Select from CH1, CH2, CH3. 1-path: For CH1 only
	Decimal Point Position	Select from a group of Velocity, Flow rate, Flow rate (%), +Total (actual), +Total pulse, -Total (actual), -Total pulse, H: Total (thermal), H: Total pulse (T), C: Total (thermal), C: Total pulse (T), Thermal flow, Thermal flow (%), Supply flow temperature, Return flow Temperature and Temperature difference.
DISPLAY 2	Selection	Same as the selection of DISPLAY 1
	Decimal Point Position	Same as the decimal point position of DISPLAY 1
LCD BACKLIGHT	Selection	Select from ON, OFF
	Lights-out time	0 to 99 min

9.14 Measurement

Click the [MEASURE] button on the Menu screen, and the following screen appears.

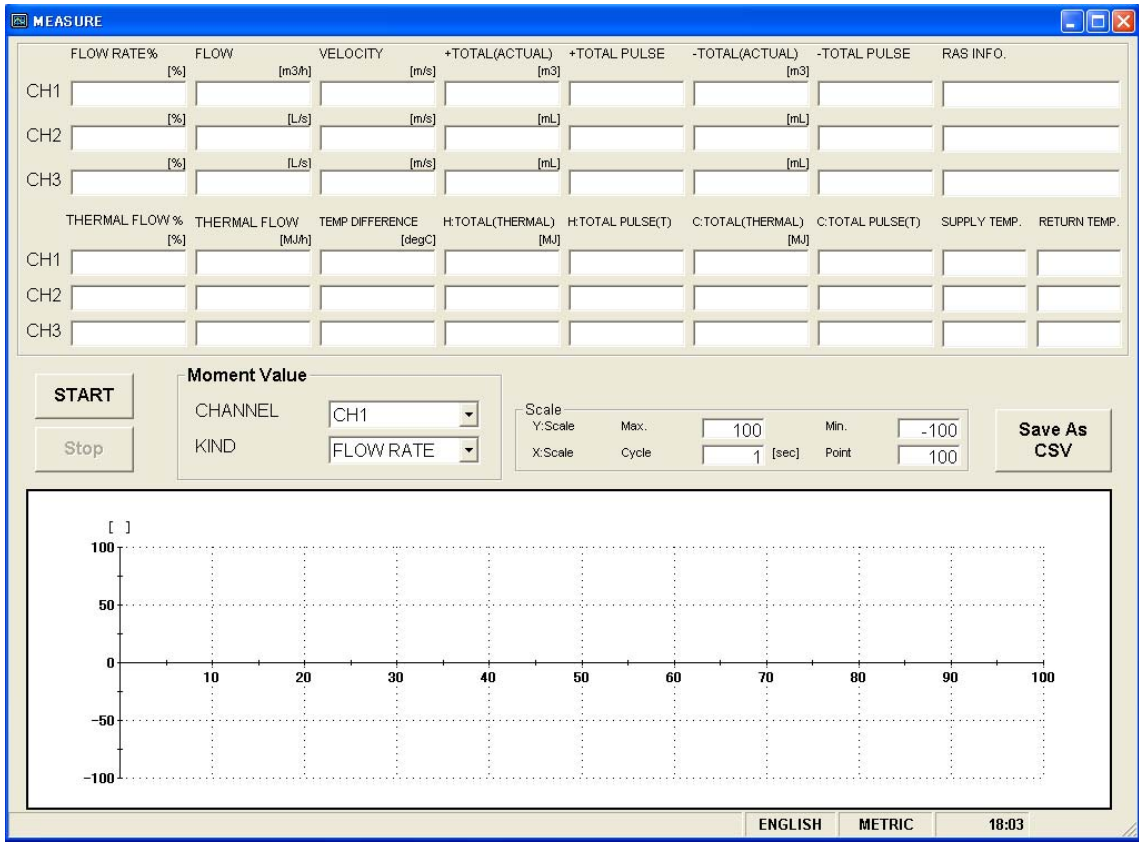

Fig. 9-22 < Measure screen >

First, select instantaneous values (channel and type) for trend display.

When the [START] button is clicked, the system reads at a preset cycle and updates data: Flow rate, Flow rate %, Velocity of flow, +Total (actual), +Total pulse, -Total (actual), -Total pulse, RAS, Thermal flow, Thermal flow %, Temperature difference, Total heat for heating (H: Total (thermal)), Total heat pulse for heating (H: Total pulse (T)), Total heat for cooling (C: Total (thermal)), Total heat pulse for cooling (C: Total pulse (T)), Supply flow temperature, and Return flow temperature.

The trend is also displayed. (Time of collection is displayed on the X-axis, and the data is deleted and time shifted when specified number of points is reached, allowing the latest value to be viewed.) The vertical axis is displayed in specified Y scale.

See Table 9-11 for details of measurement.

[Start].....Starts measuring. When setting of saving file is completed with [Save as CSV] button, [Start] button will be enabled to click.

[Stop].....Stops measuring.

[Save as CSV]When you click [SAVE], you will be asked where (storage file name) to save the data. When you enter a storage location and a storage file name. a new comma-separated CSV-formatted

In data saving in a storage file, data exceeding 32,000 lines is saved in the other new storage file. The new file name consists of a preset file name and a changing time value (yymmsshhmmss).

Note) When amount of the data to be saved on the file exceeds 32000 lines, new file will be created automatically.

Please make sure that PC hard disc has space to save the data.

e.g.) Setting of file name YYYYMMDDHHMMSS

Year, Month, Day, Hour, Minute, Second

Table 9-11 < Measurement/Detailed Setting >

Item		Content
Moment value	CHANNEL	Select from CH1, CH2, CH3. 1-path: For CH1 only
	KIND	Select from Flow rate, Flow rate %, and Velocity.
Flow rate		Read-in only
Flow rate %		Read-in only
Velocity		Read-in only
Flow rate		Read-in only
Flow rate %		Read-in only
Velocity		Read-in only
+ TOTAL(ACTUAL)		Read-in only
+ TOTA PULSE		Read-in only
- TOTAL(ACTUAL)		Read-in only
- TOTA PULSE		Read-in only
RAS		Read-in only
Thermal flow %		Read-in only
Thermal flow		Read-in only
Temperature difference		Read-in only
(Heat) Total (thermal)		Read-in only
(Heat) Total pulse (thermal)		Read-in only
(Cool) Total (thermal)		Read-in only
(Cool) Total pulse (thermal)		Read-in only
Supply flow temperature		Read-in only
Return flow temperature		Read-in only
Scale	Y scale	Enter the maximum and minimum values.
	X scale	Enter cycles and number of points. Enter cycles in the range from 1 to 3600.

9.15 Transit Time Difference Measurement

Click the [TRANSIT TIME] button on the Menu screen, and the following screen appears. Click detailed setting tab, receiving waveform tab and operation information tab when necessary.

9.15.1 Detailed Setting

CAUTION

- Do not change the setting by yourself. Otherwise measurement may be disabled.
- Make the detailed setting only when a problem should arise in flow rate measurement with factory default settings. The setting need not be made in other cases.

Click [DETAILS], and the following screen appears.

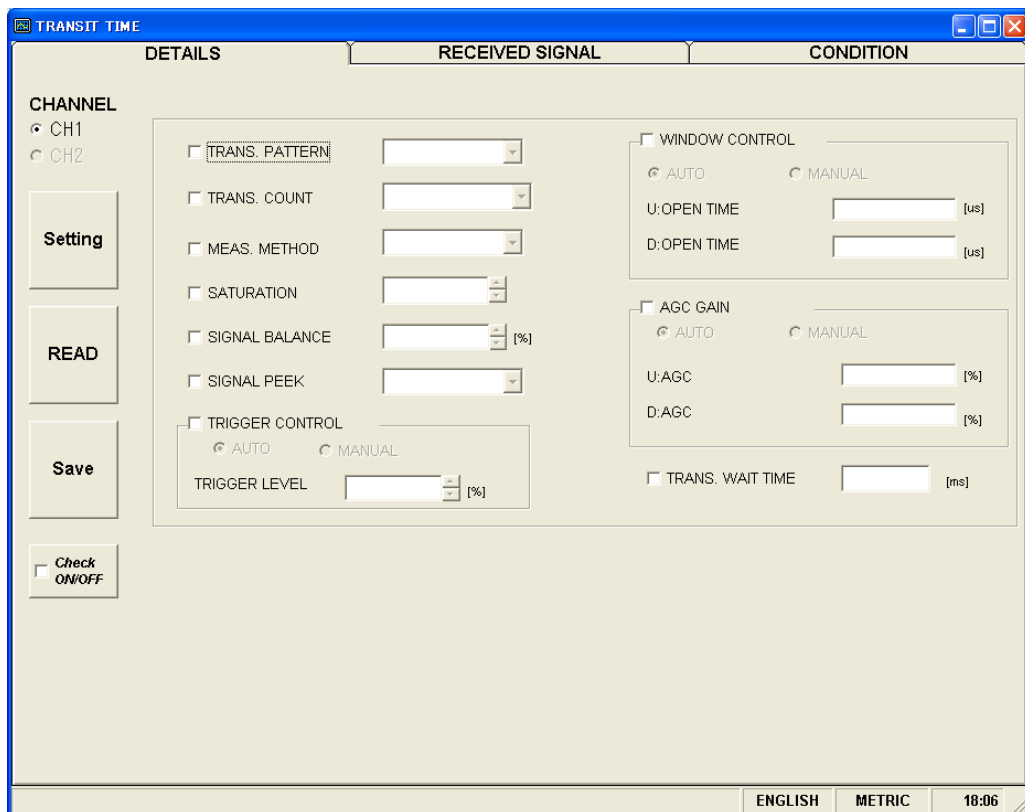

Fig. 9-23 < Detailed information screen >

Select the items to be set or read-in by checking the check box of the desired items (☑). Make the check box of the items not to be selected (or to be canceled) blank (☐).

See Table 9-12 on the next page for the details of the setting.

[Channel Select]Set or read the detailed setting of the selected channel.

When "1-path" is selected, CH2 display is disabled.

Setting of CH1 and CH2 are enabled only when "2-path" and "2-pipe" are selected.

- [Setting].....Sends the setting of the selected item (check box set to ON ()), reflecting the response value on the setting.
- [READ]Reads the setting of the selected item (check box set to ON ()), reflecting the response value on the setting.
- [Save]Reflects the setting sent by pressing the [Setting] button on the flow transmitter. Be sure to press the [Save] button if the setting is changed.
- [Check ON/OFF].....Set the check box to ON to select all the items (to set all the check boxes to ON ()). Set the check box to OFF () to release the selection of all the items (to set all the check boxes to OFF ()).

Table 9-12 < Detailed Setting >

Item	Content
TRANSMIT PATTERN	Select from BURST 1, BURST 2, BURST 3, BURST 4, BURST 5, CHIRP 4, CHIRP 8, and RESERVE.
TRANSMIT count	In case operation mode is normal: Select from 8, 16, 32, 64, 128 and 256. In case operation mode is High Speed: Select from 4, 8, 16, 32, 64 and 128.
MEASURE METHOD	Select from METHOD 1, METHOD 2 and METHOD 3.
SATURATION	Enter in the range of numeric 0 to 512.
SIGNAL BALANCE	Enter in the range of numeric 0 to 100%.
SIGNAL PEEK	Select from 0.125 V (1024), 0.25 V (2048), 0.375 V (3072), and 0.5 V (4096).
TRIGGER LEVEL	With selection of AUTO/MANUAL, in case of MANUAL, input range of numeric 10.00 to 90.00% at right column.
WINDOW CONTROL	With selection of AUTO/MANUAL, in case of MANUAL, input range of numeric 1 to 16383 in each column of U: OPEN TIME/D: OPEN TIME.
AGC GAIN	With selection of AUTO/MANUAL, in case of MANUAL, input range of numeric 1.28 to 98.56% in each column of U: AGC/D: AGC.
TRANS. WAIT TIME	Enter in the range of numeric 5 to 30 msec.

9.15.2 Received Signal (optional function)

Click "RECEIVED SIGNAL", and the following screen appears.

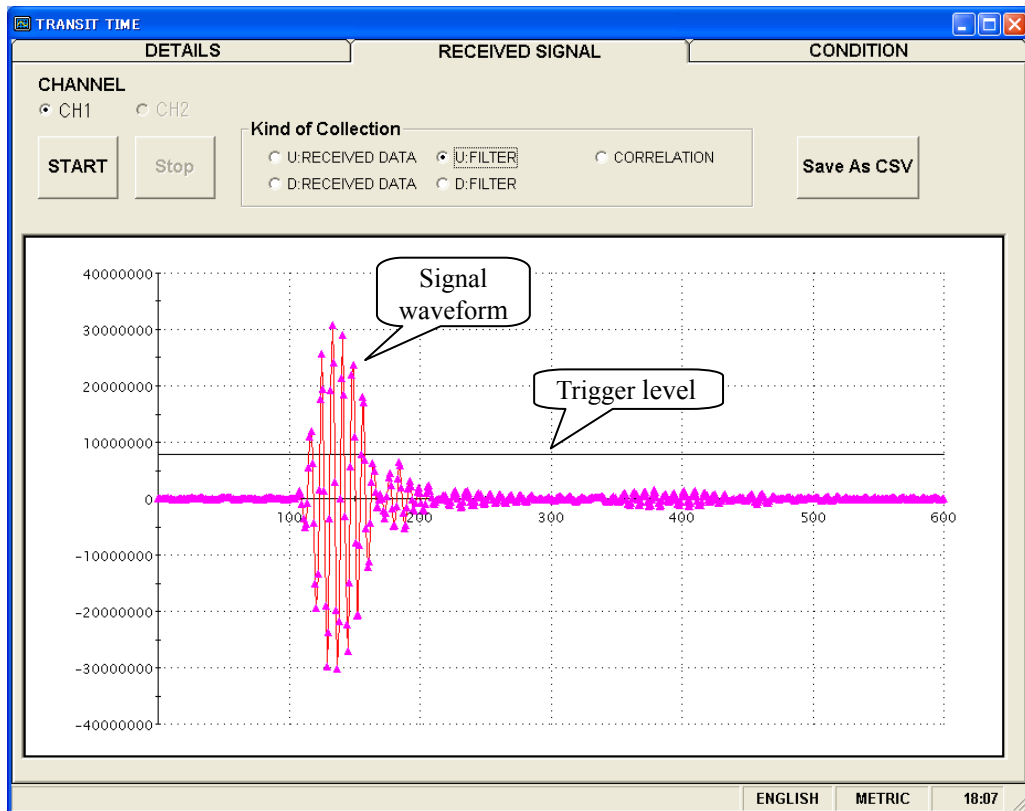

Fig. 9-24 < Received signal screen >

[Channel Select]Reads waveforms by collection type of the selected channel.

When "1-path" is selected, CH2 display is disabled.

Setting of CH1 and CH2 are enabled only when "2-path" and "2-channel" are selected.

Select one from forward direction received wave, reverse direction received wave, forward direction filter, reverse direction filter and correlation waveform. Depending on measurement method (method 1, method 2 and method 3), items which can be selected vary as shown below. Trigger level is also displayed.

Left-click the mouse while pressing the shift key to specify the screen range, and the selected range is magnified. Press the R key to return to original status.

- Method 1: One from forward direction, reverse direction and correlation waveform can be selected.
- Method 2: One from forward direction, reverse direction, forward direction filter and reverse direction filter can be selected.
- Method 3: One from forward direction, reverse direction, forward direction filter and reverse direction filter can be selected.

[Start].....Starts reading.

[Stop].....Stops reading.

[Save As CSV].....Saves the measurement result in a file in CSV format. Click the button, and you are prompted to enter the name of a file to which the data is to be saved. Specify the destination to save and enter the file name, and a CSV file is created.

Point

1. Startup is completed within 3 to 6 waves.
2. No peak (amplitude) fluctuation should be observed. Otherwise air is mixed in.

See “Checking send/receive” in “6. Maintenance and Inspection” of the separate instruction manual, “FIXED TYPE ULTRASONIC FLOWMETER” INF-TN2FSVL-E, for receive waveforms.

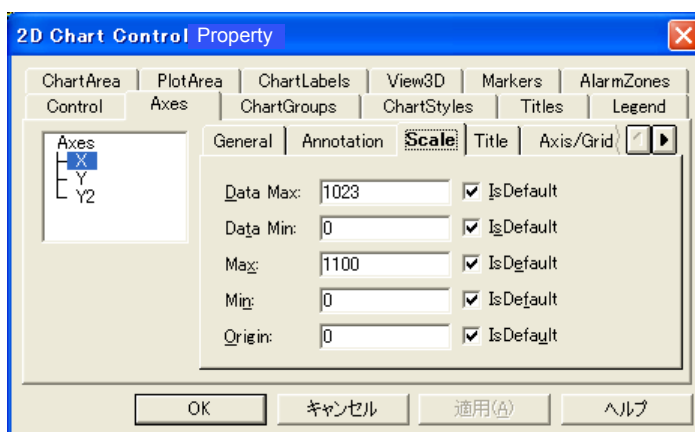

* Right-click on the [Measurement] or [Receive waveform] screen, and scale can be adjusted.

9.15.3 Operation Information

Click “CONDITION”, and the following screen appears.

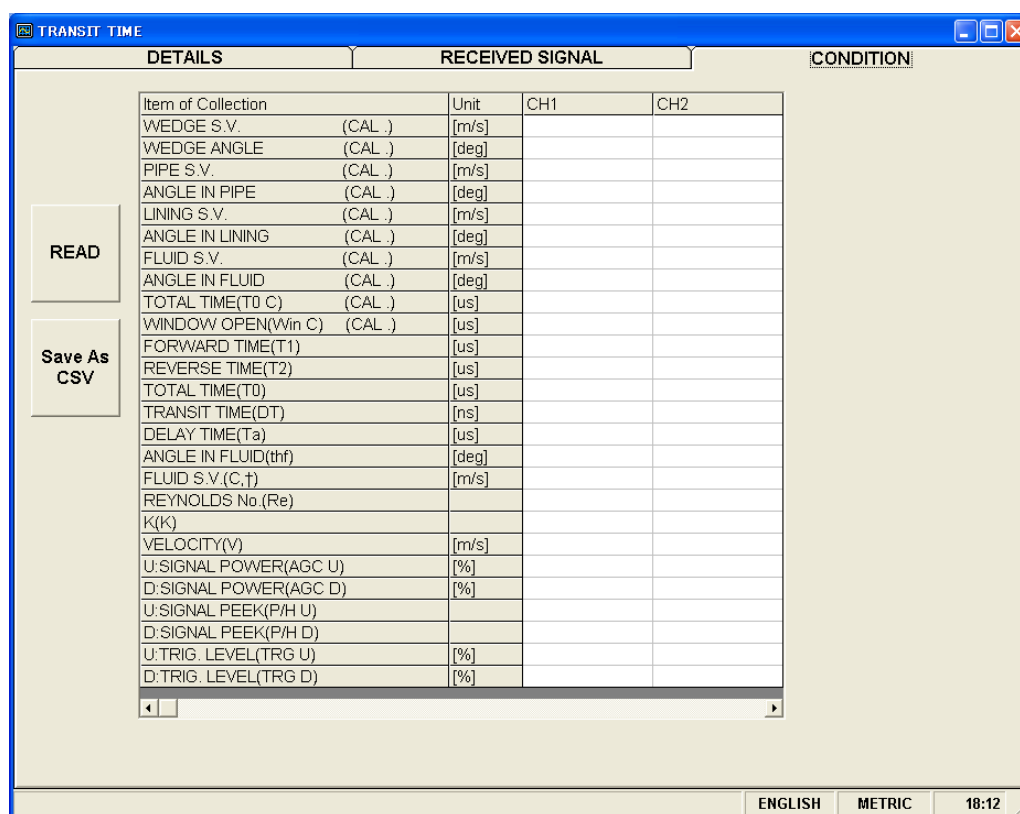

Fig. 9-25 < Operation Information screen >

Select either Line 1 or Line 2 first.

[Read]..... Reads operating information of CH1 and CH2 together.

1-path: Reads operating information of CH1.

[Save As CSV] Saves Operation Information in file with CSV format. Click the button, and you are prompted to enter the name of a file to which the data is to be saved. Specify the destination to save and enter the file name, and a CSV file is created.

Table 9-13 < Operation Information >

Item	Content
WEDGE SOUND VELOCITY	m/s [ft/s]
WEDGE ANGLE	°
PIPE SOUND VELOCITY	m/s [ft/s]
ANGLE IN PIPE	°
LINING SOUND VELOCITY	m/s [ft/s]
ANGLE IN LINING	°
FLUID SOUND VELOCITY	m/s [ft/s]
ANGLE IN FLUID	°
TOTAL TIME	μs
WINDOW OPEN (Win C)	μs
FORWARD TIME	μs
RESERVE TIME	μs
TRANSIT TIME	ns
DELAY TIME	μs
FLUID SOUND VELOCITY	m/s [ft/s]
ANGLE IN FLUID	°
REINOLDS No. (Re)	
K	
VELOCITY	m/s [ft/s]
U: SIGNAL POWER (AGC U)	% * When measurement is normal: 35% or higher
D: SIGNAL POWER (AGC D)	% * When measurement is normal: 35% or higher
U: SIGNAL PEEK (P/H U)	* When measurement is normal: Stabilizes within the range from 5528 to 6758.
D: SIGNAL PEEK (P/H D)	* When measurement is normal: Stabilizes within the range from 5528 to 6758.
U: TRIG. LEVEL (TRG U)	%
D: TRIG. LEVEL (TRG D)	%

See “Displaying data in maintenance mode” in “6. Maintenance and Inspection” of the separate instruction manual, “FIXED TYPE ULTRASONIC FLOWMETER” INF-TN2FSVL-E, for the operation information.

9.16 RAS

Click the [RAS] button on the menu screen to display the RAS screen shown below.

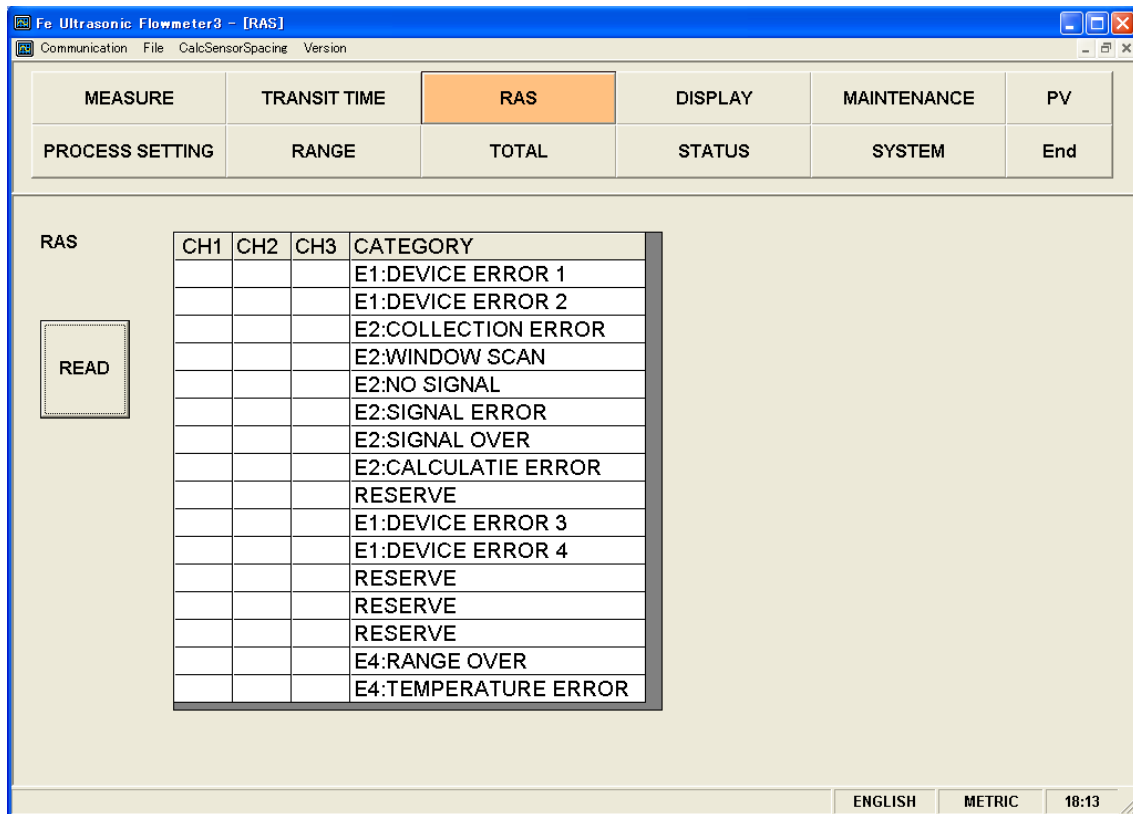

Fig. 9-26 < RAS screen >

[READ] button Displays RAS information (16 items from 0/1 to 0/16).

When "1-path" is selected, CH2 and CH3 displays are disabled.

CH1, CH2, and CH3 can be read when "2-path" and "2-pipe" are selected.

9.17 Maintenance

Click the “MAINTENANCE” button on the Menu screen, and the following screen appears.

Note: If [Setting] and [Read] are executed on this screen, the instrument is in the Maintenance mode for flowmeter.

Be sure to reset the Maintenance mode of flowmeter by clicking the [Release] button.

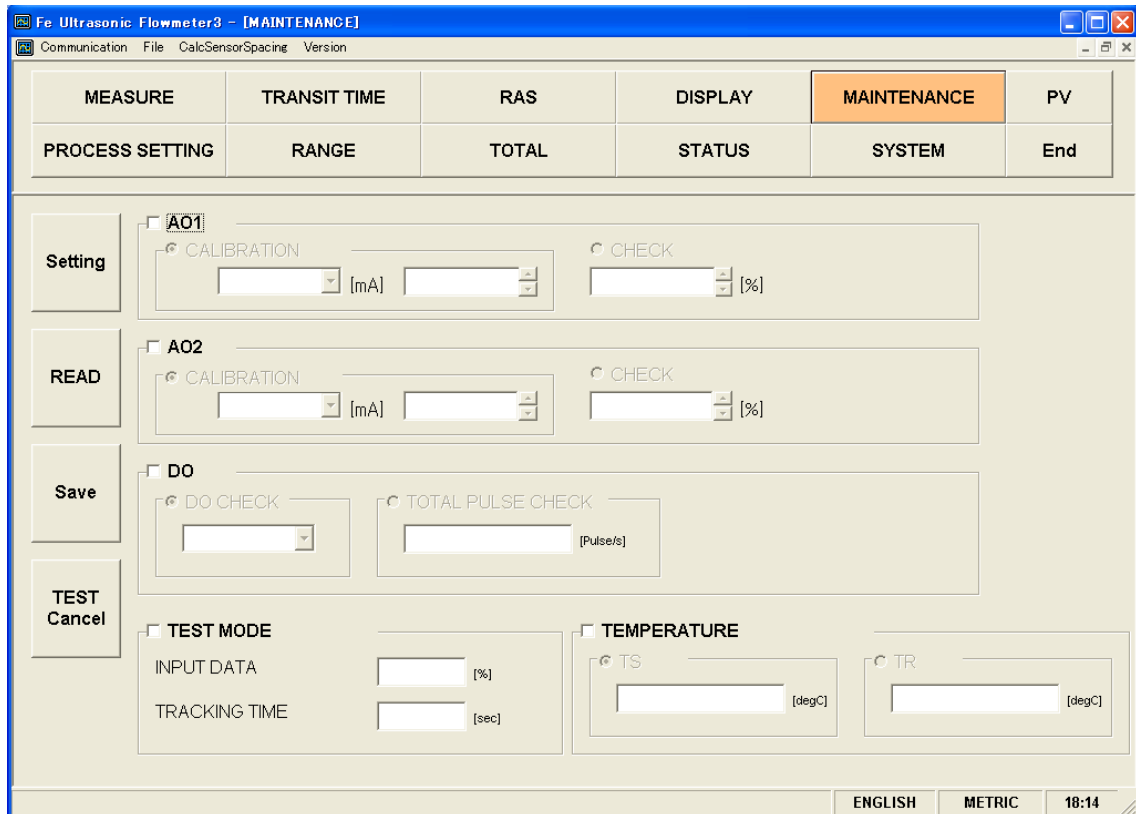

Fig. 9-27 < Maintenance screen >

Select the items to be set or read-in by checking the check box of the desired items (). Make the check box of the items not to be selected (or to be canceled) blank (.

See Table 9-14 on the next page for details of the maintenance.

[Setting] button.....Sends the setting of the selected items () and reflects the response value to the setting.

[READ] buttonRead-ins the setting of the selected items () and reflects the response value to the setting.

[Save] buttonReflects the setting sent by pressing the [Setting] button to the flow transmitter. Note that However, you cannot save AO check, DO check, integration pulse check, test mode, input data, tracking time, and temperature input data.. Be sure to click the [Save] button if AO is adjusted.

[TEST Cancel] button..Cancels the AO/DO/Test mode.

* Be sure to press the [TEST Cancel] button when maintenance is completed.

Table 9-14 < Maintenance/setting >

Item	Content
AO1 and AO2 adjustment	When 4mA is selected, without decimal point, Enter in the range from 50 to 7148. When 20mA is selected, without decimal point, Enter in the range from 7148 to 15950. Select "4mA" or "20mA" and then click [READ]. The adjusted value is listed in the right pane. Connect an ammeter and use it for adjustment. Click the [SET] button to change the adjusted value.
AO1 and AO2 check	Without decimal point, Enter in the range from -20 to 120%.
DO check	Select ON or OFF.
DO total pulse check	Without decimal point, Enter in the range from 1 to 100 Pulse/s.
Test mode	Check the check box (<input checked="" type="checkbox"/>) to enter the test mode. Exit the test mode if either input data or tracking time is entered and the check box is blank (<input type="checkbox"/>)
Input data	Without decimal point, Enter in the $\pm 120\%$ range.
Tracking time	Without decimal point, Enter in the range from 0 to 900 sec.
Temperature check	Select TS (feeding fluid temperature) or TR (returning fluid temperature), and then click the [READ] button.

9.18 PV

Click the [PV] button on the menu screen to display the PV screen (when RS-485 communication system is selected only).

CAUTION

- Do not start or operate the other application while the measurement is in progress. The measurement may not be successful.

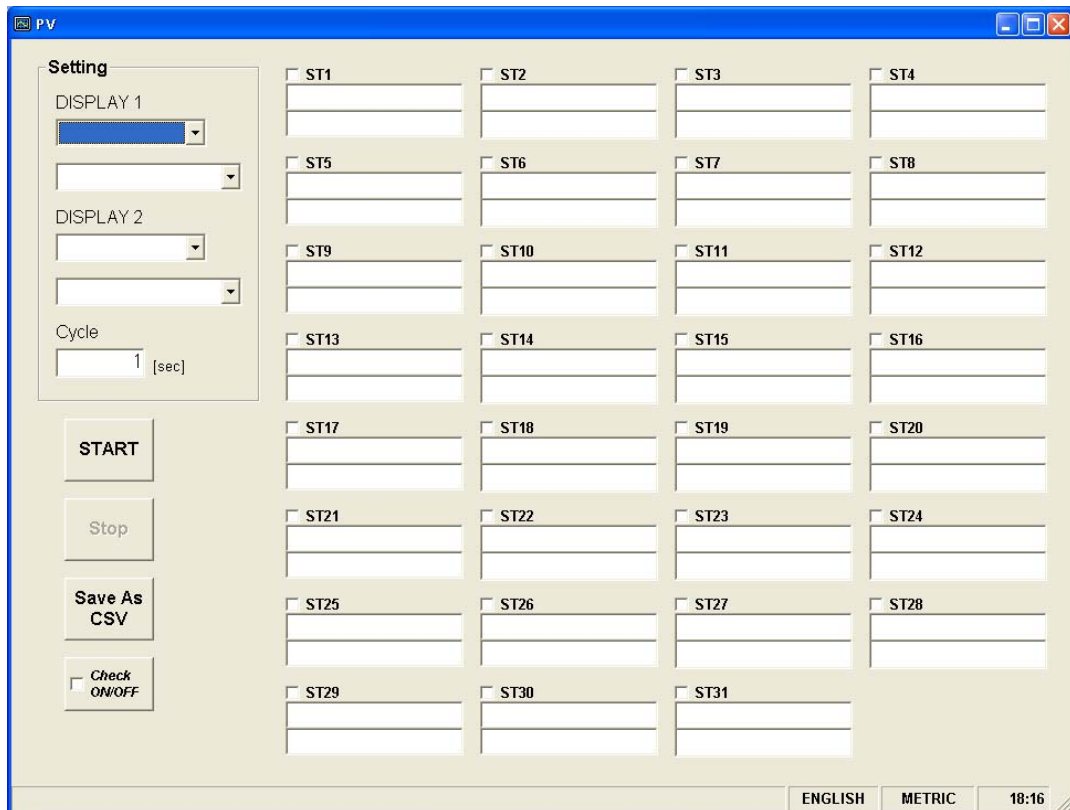

Fig. 9-28 < PV screen >

Select the station No. to be measured by checking the check box of the desired item (). Make the check box of the items not to be selected (or to be canceled) blank ().

The number of measurable units can be calculated by the following expression:

$$\text{Number of measurable units} = \text{Cycle (sec)} / 0.5 \text{ sec}$$

See Table 9-15 for details of PV.

[START] button.....Starts the measurement of the selected device (☑). When setting of saving file is completed with [Save as CSV] button, [Start] button will be enabled to click.

[Stop] button.....Stops transmission.

[Save as CSV] buttonSaves the measurement data of each device in a file in CSV format.

On clicking the button, you are asked where to save the data as well as the name of the file. Enter the place to save data and the name of the file, and a file in CSV format is created.

In data saving in a storage file, data exceeding 32,000 lines is saved in the other new storage file. The new file name consists of a preset file name and a changing time value (yymmsshhmmss).

Note) When amount of the data to be saved on the file exceeds 32000 lines, new file will be created automatically.

Please make sure that PC hard disc has space to save the data.

e.g.) Setting of file name YYYYMMDDHHMMSS

Year, Month, Day,
Hour, Minute, Second

[Check ON/OFF] check buttonCheck the check box (☑) to select all the items. (The check boxes for all the items are checked (☑)). Keep the check box blank (☐) to cancel the selection of all the items. (The check boxes for all the items are made blank (☐)).

Table 9-15 < PV Setting >

Item		Content
DISPLAY 1	Channel Select	Select from CH1, CH2, CH3. 1-path: For CH1 only
	Type	Select from Select from VELOCITY, FLOW RATE, + TOTAL (ACTUAL), – TOTAL (ACTUAL), + TOTAL PULSE, – TOTAL PULSE, RAS, H: Total (thermal), H: Total pulse (T), C: Total (thermal), C: Total pulse (T), Thermal flow, Thermal flow (%), Supply flow temperature, Return flow Temperature, and temperature difference.
DISPLAY 2		Same as the selection of DISPLAY 1
CYCLE		Enter in range of 1 to 60 sec.

9.19 End

Click the [End] button on the Menu screen, and the following screen appears.

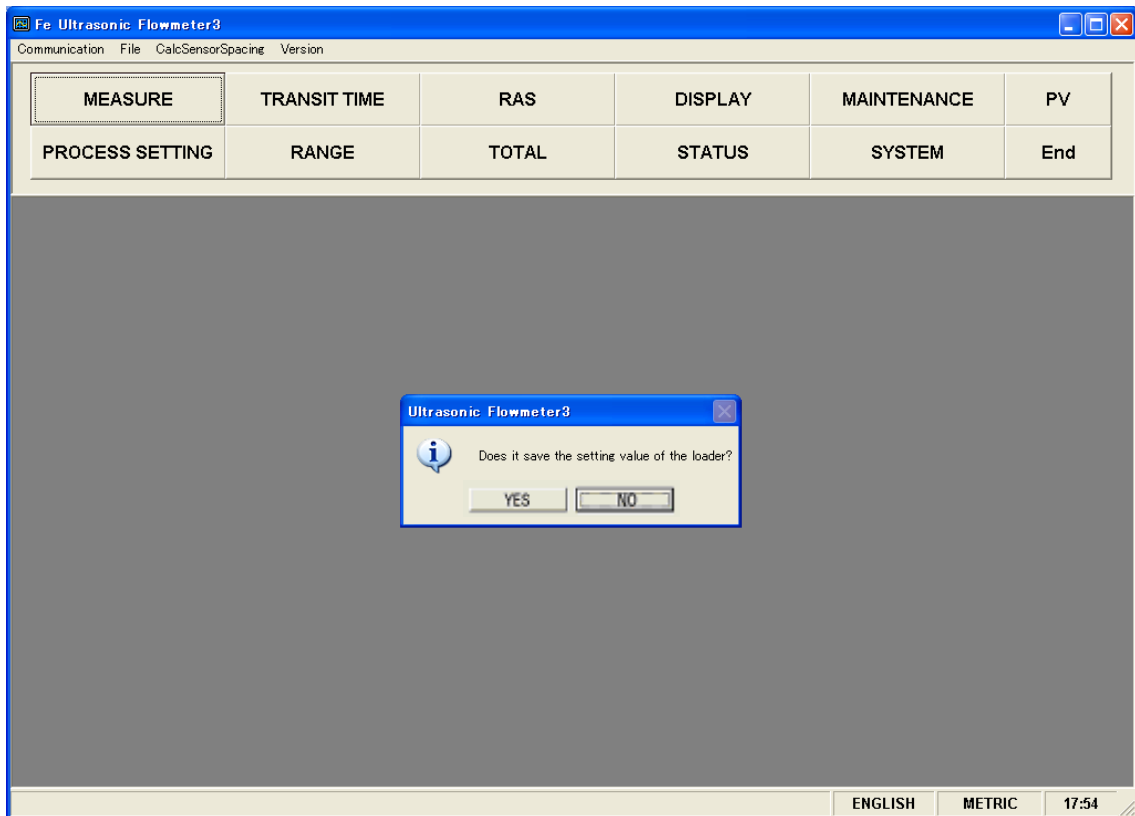

Fig. 9-29 < Menu screen >

Click either the [End] button or the (☒) button, and a message asking you whether you want to save the loader setting appears. To save setting value, select “Yes”. On the file designation window that appears, select a file, and the setting is saved in the file. Then the loader is terminated. Not to save setting value, select “No”, and the loader is terminated without saving the setting.

9.20 Uninstalling of Software

Select “Addition and Deletion of Application” from “Control Panel” of Windows, and click [Change and Deletion] to uninstall the software.

10. TROUBLESHOOTING

If the communication is unavailable, check the following items.

- Whether all devices related to communication are turned on.
- Whether connections are correct.
- Whether the number of connected instruments and connection distance are as specified.
- Whether communication conditions coincide between the master station (host computer) and slave stations.
 - Transmission speed: 9600bps
 19200bps
 38400bps
 - Data length: 8 bits
 - Stop bit: 1 bit
 - Parity: odd
 even
 none
- Whether send/receive signal timing conforms to Section 5.3 in this manual.
- Whether the station No. designated as send destination by the master station coincides with the station No. of the connected FSV.
- Whether more than one instrument connected on the same transmission line shares the same station No.
- Whether the station No. of instruments is set at other than 0.
If it is 0, the communication function does not work.
- Whether the 5th digit of type cord of this Flow transmitter is A ?
(FSV□A□□2-□□□□□)

 Fuji Electric Co., Ltd.

**International Sales Div
Sales Group**

Gate City Ohsaki, East Tower, 11-2, Osaki 1-chome,
Shinagawa-ku, Tokyo 141-0032, Japan
<http://www.fujielectric.com>
Phone: 81-3-5435-7280, 7281 Fax: 81-3-5435-7425
<http://www.fujielectric.com/products/instruments/>
