

Module type
Temperature controller PUM

User-friendly due to enhanced functions!

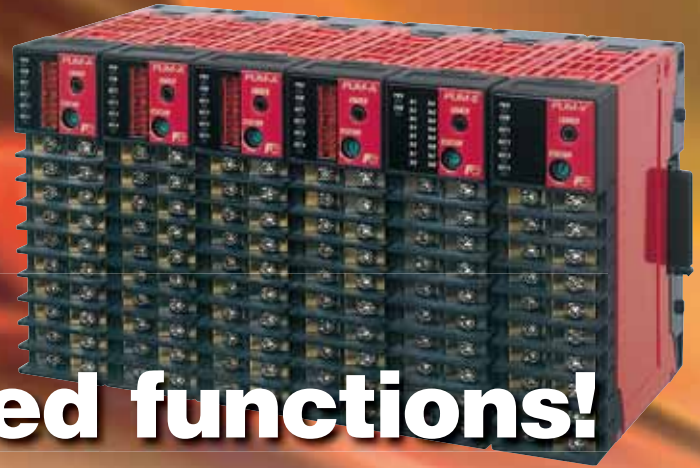

Addition of ramp soak function

Programmable up to 64 ramp soak

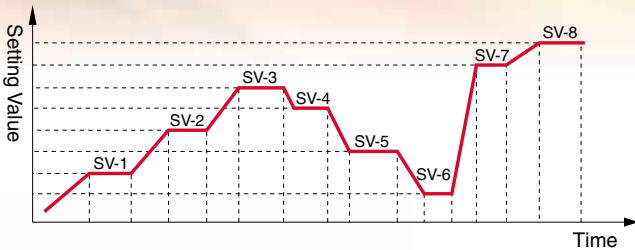

<Ramp soak function>

Setting up the heat pattern to control a pattern of increasing/decreasing temperature. Start operation and reset can be conducted externally.

Control of motorized valve is enabled

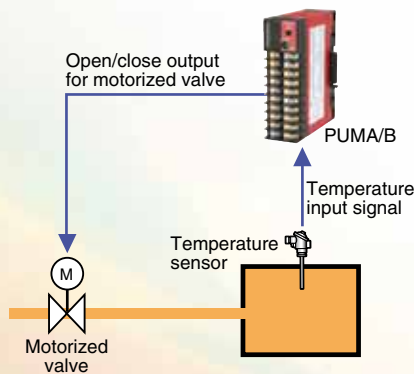

Motorized valve drive signal
• 1a relay contact
• 220V AC/ 30V DC
3A (resistance load)

Note)
Two outputs are used for motorized valve control.
Not available of position feedback input from controller

Expansion of the input functions

- Expansion of the input range of resistance bulb and thermocouple -200 to 850 °C
- Addition of voltage input $\pm 5V, \pm 10V_e$
- Settable unassigned terminal for input
- Selectable PV to be obtained from own module.
(Changeable by DI input)

Expansion of output functions

- Alarm output (DO) can be output from control output.
- Settable unassigned terminal for output.
- Cool control output can be output from other control module or event module

Cascade control can be conducted without external wiring

e.g.:
Cascade control is set that Ch.1 is for master loop and Ch.2 is for slave loop.

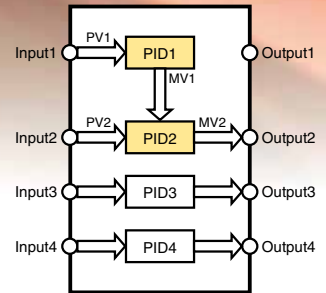

High-speed control

Input sampling cycle 100ms

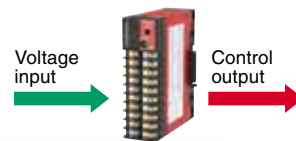

Note)
when thermocouple/resistance bulb input is selected, it is 200ms.

Expansion of heater current (CT) input functions

- It is easy to monitor the current by using CT input. (Applicable to current output type. Alarm function can not be operated during monitor operation.)
- Changeable of CT input terminal arrangement.
(When single-phase CT, one cable can measure for 4 channels.)

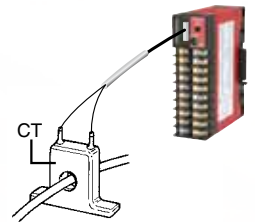

Addition of new functions to PC loader

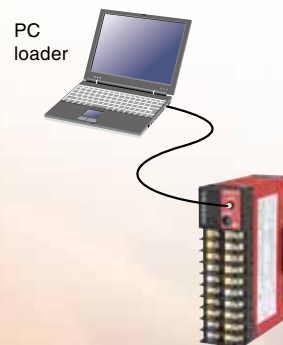

- Operation as if using Excel
- Applicable to Windows 7
- Function of creating as a new. (parameter setting file can be created without PUM)
- Display function for seeing a changed part of parameter. (comparison between displayed value and factory default value / displayed value and using unit)
- Saving function of favorite file.
- Modification function of station No.
- simplified monitor function

CODE SYMBOLS

Control module (4channels)

Digit	Description	PUM
4	<Module type> 4ch control module	A
5	<Input type> Thermocouple /Resistance bulb (all channels) Voltage/current (all channels) Thermocouple/Resistance bulb (ch1,2), voltage/current (ch3,4)	T A C
6	<OUT1, 2 output type> Relay output SSR drive output Current output (4 to 20mA)	A C E
7	<OUT3, 4 output type> Relay output SSR drive output Current output (4 to 20mA)	A C E
8	<Revision No.>	1
10	<Operation Manual> Japanese English	A B
11	<Option> Not fitted CT input (8 points)	Y C

Control module (2channels)

Digit	Description	PUM
4	<Module type> 2ch control module	B
5	<Input type> Thermocouple/Resistance bulb (all channels) Voltage/current (all channels)	T A
6	<OUT1, 2 output type> Relay output SSR drive output Current output (4 to 20mA)	A C E
7	<OUT3, 4 output type> None Relay output SSR drive output Current output (4 to 20mA)	Y A C E
8	<Revision No.>	1
10	<Operation Manual> Japanese English	A B
11	<Option> Not fitted CT input (4 points)	Y C

Event input/output module

Digit	Description	PUM
4	<Module type> Event input/output module (DI 8 points/ Do 8 points)	E
5	<Output type> Open collector (sink) output Relay contact output	C R
8	<Revision No.>	1
10	<Operation Manual> Japanese English	A B

Input/output analog module

Digit	Description	PUM
4	<Module type> analog input/output module AI4/AO4 analog input module AI4 analog output module AO4	V N T
5	<Input type> Note 1 Input: Thermocouple /Resistance bulb (all channels) Note 1 Input: Voltage/current (all channels) Note 1 Input: Thermocouple /Resistance bulb (ch1,2) Voltage/current (ch3,4) Note 2 Analog output module	T A C Y
6	<OUT1, 2 output type> Note 3 None Note 4 Current output (4 to 20mA)	Y E
7	<OUT3, 4 output type> Note 3 None Note 4 Current output (4 to 20mA)	Y E
8	<Revision No.>	1
10	<Operation Manual> Japanese English	A B

Note1 "V" or "N" should be specified at 4th digit.
Note2) "T" should be specified at 4th digit.

Note3) "N" should be specified at 4th digit.
Note4) "V" or "T" should be specified at 4th digit.

Enhanced communication module

Digit	Description	PUM
4	<Module type> enhanced communication modul	C
5	<Communication module> CC-Link communication MITSUBISHI –PLC Program-less communication PROFIBUS communication	L M P
8	<Revision No.>	1
10	<Operation Manual> Japanese English	A B

Accessories

行	仕様	PUMZ*
6	RS485 terminating resistance	A 0 1
7	Note1 DIN rail mounting end plate	A 0 2
8	Note1 Side connecting terminal cover (right & left 1set) Note1 Front face screw terminal cover	A 0 3 A 0 4
	Note2 Loader connecting cable (RS232C)	L 0 1
Note3,4	CT input terminal cable (for 4 points) (l=1m)	C 0 1
Note3,4	CT input terminal cable (for 4 points) (l=3m)	C 0 3
Note3,4	CT input terminal cable (for 4 points) (l=5m)	C 0 5
	CT for 1 to 30A (CTL-6-S-H)	C T 1
	CT for 20 to 50A (CTL-12-S36-8)	C T 2

Note1) ten units/per order

Note2) When connecting through USB port, use the commercial USB serial converter cable together.

Note3) A single CT input cable is for 3-phase and 2channels (CT 4points) or single-phase and 4channels (CT 4points)

Note4) Connection of the cable to CT sensor should be arranged by user.

Avadant variety of modules



Common specification

Power supply voltage	24V DC
Measurement accuracy	±0.3%FS
Calculation cycle	200ms (voltage input type: 100ms)
Communication function	RS-485(MODBUS)
Loader communication	RS-232C(MODBUS)
Installation method	Rail mounting or wall mounting
Dimensions	30(W) x 100(H) x 85(D)mm

Control module (Type: PUMA/B)

No. of input	2points or 4points
Input signal	Thermocouple, resistance bulb, voltage/current
No. of output	2points or 4points
Control output signal	Relay contact, current output, SSR/SSC drive
Control methods	ON/OFF,PID, heat, cool, valve
Function	Auto, Manual, Remote
Option	CT input (4 or 8 points)

Event input/output module (type: PUME)

No. of DI	8points
No. of DO	8points
DO type	Relay contact or transistor output

Analog input/output module (type: PUMV/N/T)

No. of input	4points
Input signal	Thermocouple, resistance bulb, voltage/current
No. of output	4points
Output signal	4 to 20mA DC, 0 to 20mA DC

CC-link communication module (type: PUMCL)

Version	CC-Link Ver. 2.00/1.10
---------	------------------------

PLC communication module (type: PUMCM)

PLC version	MELSEC-Q/A/AnS, FX series
-------------	---------------------------

PROFIBUS communication module (type: PUMCP)

Version	PROFIBUS · DP-VO
---------	------------------

Fuji Electric Co., Ltd.

International Sales Div.

Sales Group

Gate City Ohsaki, East Tower, 11-2, Osaki 1-chome, Shinagawa-ku, Tokyo 141-0032, Japan

http://www.fujielectric.com

Phone: 81-3-5435-7280, 7281 Fax: 81-3-5435-7425

http://www.fujielectric.com/products/instruments/