

Quasi-resonant Controller IC

Hiroshi Maruyama
Hironobu Shiroyama
Takaaki Uchida

1. Introduction

The problem of global warming has attracted considerable attention in recent years, and requirements for energy savings in all electronic products, and regulations prescribing the amount of standby power per product type and the like are becoming more and more severe with each passing year.

Under these circumstances, Fuji Electric has developed energy-saving AC-DC converter switching mode power supply controller ICs for converting an AC line input voltage (100 V, 240 V AC) to a DC voltage. Among these ICs, Fuji has moved ahead with the commercialization of a control IC that is effective in reducing the standby power in an internal high-voltage startup current source, and has developed the FA5516 series of PWM (pulse width modulation) control ICs for fixed frequency operation. These types of ICs contain an internal high-voltage startup current source that functions to supply startup current from a high-voltage input line of 100 to 240 V AC to the VCC pin of the control IC prior to switching, and then to stop that startup current when the transformer's secondary side voltage rises after the switching has started. In the past, a startup resistor was used, and startup current flowed continuously while the IC was operating, but with Fuji Electric's newly developed IC, switching can be implemented so that the startup current only flows when necessary.

This paper presents an overview of Fuji Electric's newly developed FA5530 and FA5531 quasi-resonant controller ICs equipped with an internal high-voltage startup current source.

2. Product Overview

2.1 Features

The FA5530 and FA5531 are AC-DC power supply controller ICs developed for switching mode power supplies that use quasi-resonant control. By indirectly sensing the drain voltage of a power MOSFET (metal oxide semiconductor field-effect transistor) via the voltage of an auxiliary winding, and then by turning ON the next cycle at a timing determined by the

Fig.1 External view of products

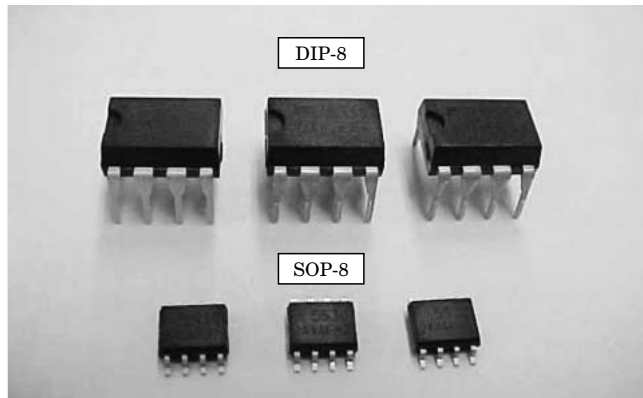
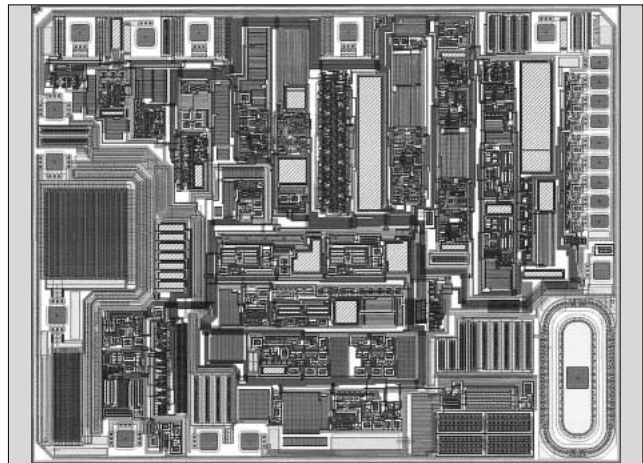

Fig.2 Chip configuration of the FA5531



minimum voltage during resonant operation after the energy stored in the transformer has been supplied to the secondary side, lower switching loss, higher efficiency and lower noise can be achieved more easily, and these ICs are well suited for applications such as power supplies for printers and LCD TVs in which noise has been a problem.

Figure 1 shows an external view of the product packages (DIP-8 and SOP-8), and Fig. 2 shows the chip configuration of the FA5531. Features of the FA5530 and FA5531 ICs are described below.

(1) A 500 V high-voltage JFET (junction field-effect

transistor) is built-in, and the IC supplies or stops the flow of charging current from the VH pin to the capacitor of the VCC pin.

While current is being supplied:

7 to 3.5 mA ($V_{CC} = 0$ V to UVLO off)

While current is stopped: 20 μ A

- (2) Quasi-resonant control during operation at a light load causes the switching frequency to increase. But in these ICs, the switching frequency is decreased, by limiting the maximum switching frequency, or by reducing the maximum frequency linearly if the FB pin voltage (feedback voltage from the secondary side) drops below 1.3 V.

Maximum switching frequency: 65 kHz (FA5530)

130 kHz (FA5531)

Minimum switching frequency: 1 kHz

(FA5530, FA5531)

- (3) The ZCD pin senses transitions from high to low values of the auxiliary winding voltage. The threshold voltages are $V_{HL} = 62$ mV and $V_{LH} = 152$ mV with hysteresis, and the upper and lower limits of the ZCD input voltage are clamped at 9.2 V ($I_{zcd} = 3$ mA) and -0.75 V ($I_{zcd} = -2$ mA), respectively. Additionally, by externally pulling up the ZCD pin to at least 8 V, latched stopping can be forcibly implemented.
- (4) The VCC pin contains a built-in UVLO (undervoltage lockout) circuit having hysteresis. $V_{CC} = 9.85$ V when ON, and = 9.10 V when OFF
- (5) The IS pin is for sensing the current of an external MOSFET, and the maximum input level is 1 V. In order to prevent malfunctions due to noise when the pin is ON, a blanking time of 380ns is set.
- (6) Various protection functions are built-in, including overload protection (auto restart), VCC pin overvoltage protection (latch), soft-start (internally fixed at 1 ms), etc.
- (7) The package supports high voltages and is available in two varieties, DIP-8 and SOP-8. The high-voltage startup current source (VH) pin is set to pin 8, and pin 7 remains as a non-connected (NC) pin.

2.2 Operation during light load condition

Figure 3 shows a block diagram of the entire IC.

With quasi-resonant control, the energy stored in the transformer during the power MOSFET's ON period is transferred to the secondary side during the OFF period, and when the release of energy is complete, resonance is initiated between the transformer inductance L and the drain capacitance C , and the voltage oscillates. Utilizing this control, the next cycle turns ON at a timing corresponding to when the drain voltage decreases to its minimum value, and switching is performed when the current flowing through the transformer is zero and when the drain voltage is small, thereby enabling a reduction in

Fig.3 Block diagram of the FA5531

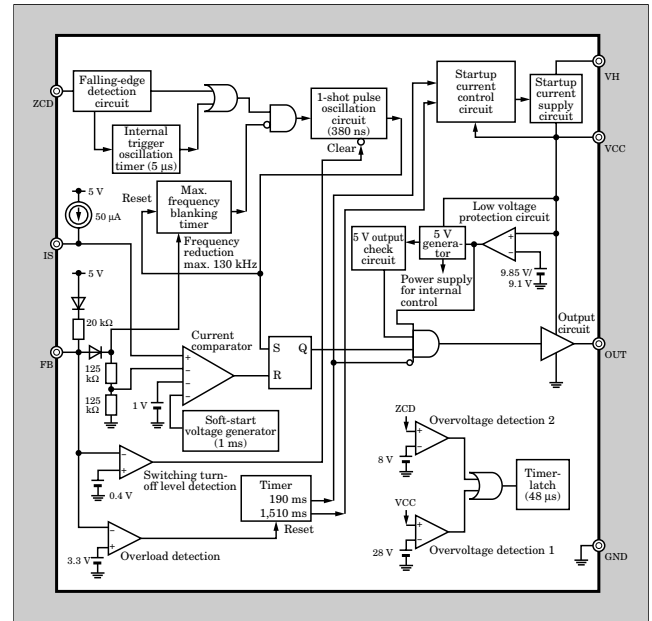

switching loss and noise.

The ZCD pin of Fig. 3 is connected to the auxiliary winding of the transformer through a resistor, and the waveform appearing at this pin has nearly the same shape as the drain waveform of the power MOSFET connected to the primary winding, but has an amplitude that is a fraction of the number of windings and is centered about ground level. The timing at which this waveform falls from a high-level to ground level is sensed, an ON trigger is output (falling edge signal), and adjustment is made so that the cycle turns ON at the actual minimum, taking into account the delay time.

Figure 4 shows the relationship between the load condition (output power P_o) and the switching frequency (f_{sw}) of the power MOSFET, and Fig. 5 shows an image of the change in operating waveforms according to the load condition. When the load is heavy, after the transformer releases its energy, a resonant state is entered and then the next cycle turns ON at the first timing of voltage minimum. At this time, since the ON period and the flyback period during which energy is transferred to the secondary side are both extended, the switching is implemented at a low frequency.

As the load becomes lighter, the abovementioned periods become shorter, and the frequency increases. The FA5531 contains an internal timer (maximum f_{sw} blanking) that counts 7.69 μ s (130 kHz) from the ON time, and falling-edge signals are ignored during this period in order to limit the maximum switching frequency to 130 kHz or less.

As the load becomes even lighter, if the voltage of the FB pin that receives the feedback signal from the secondary side drops to 1.3 V or less, the abovementioned maximum frequency limit is decreased linearly, the number of switching operations is reduced, and the

Fig.4 Relationship between output power (load) and switching frequency

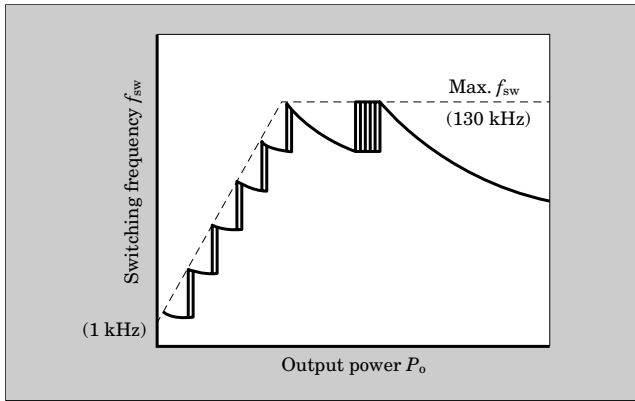
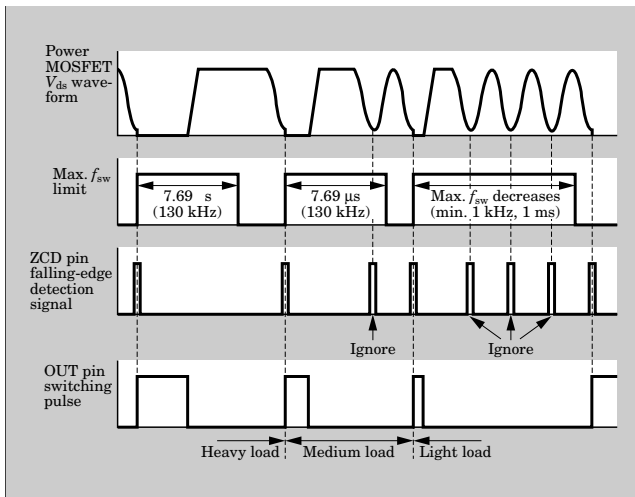

Fig.5 Load condition and operating waveforms



minimum frequency can be lowered down to approximately 1 kHz (See Fig. 4).

2.3 Operation during overload condition

Figure 6 shows waveforms during operation at an overload condition. An overload condition is sensed when the FB pin voltage is 3.3 V or above, and after a delay time of 190 ms following the sensing of the overload condition, the switching is stopped. Consequently, the startup time must be adjusted with smoothing capacitors or the like, provided there are no problems, such that the secondary side rises to its normal value and the FB pin voltage falls within 190 ms. Once an overload stoppage has occurred, the stopped state is maintained for approximately eight periods of 1,510 ms, and then the IC is reset and restarted. During the period while stopped, if the VCC voltage drops down to 9.85 V, the high-voltage startup current source turns ON, the IC repeatedly operates to raise the voltage to 11.55 V with the supply from the VH pin, the startup circuit becomes inoperable after 1,510 ms, and a reset is implemented at the point in time when the VCC pin voltage drops down to the UVLO stop voltage 9.1 V.

Fig.6 Waveforms during an overload condition

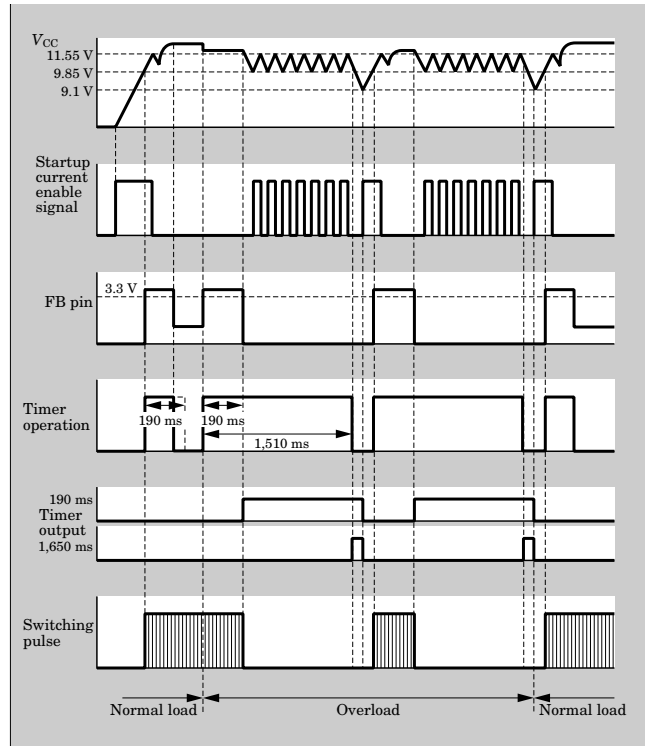

3. Application to Power Supply Circuits

3.1 Power supply for evaluation use

In order to verify the operating characteristic of a power supply circuit that uses this IC, a power supply was built for the purpose of evaluation and its operating characteristics verified (See Fig. 7).

Main specifications of the power supply that was built for the evaluation are listed below:

- Input line voltage: 80 to 264 V AC, 50/60 Hz
- Output: 19 V DC, 5 A (95W)
- Protection functions:
 - Overload protection (auto restart), overcurrent control, overvoltage protection (latch)
- IC used: FA5531 (maximum frequency: 130 kHz)

3.2 Maximum switching frequency limiting

Figure 8 shows the switching waveform at the rated load. From this waveform, it can be seen that turn-ON occurs at the resonance minimum. At this time the switching frequency is approximately 40 kHz.

Figure 9 shows the switching waveform at an approximate 30% load condition (1.6 A output current). Generally, in the case of quasi-resonant control, the switching frequency increases as the load becomes lighter, but this IC has a function for limiting the maximum frequency, and when the switching frequency reaches its upper limit, the resonance minimum is skipped in order to suppress the increase in switching frequency. In Fig. 9, it can be seen that after one resonance minimum is skipped, an ON region appears

Fig.7 Evaluation SMPS circuit

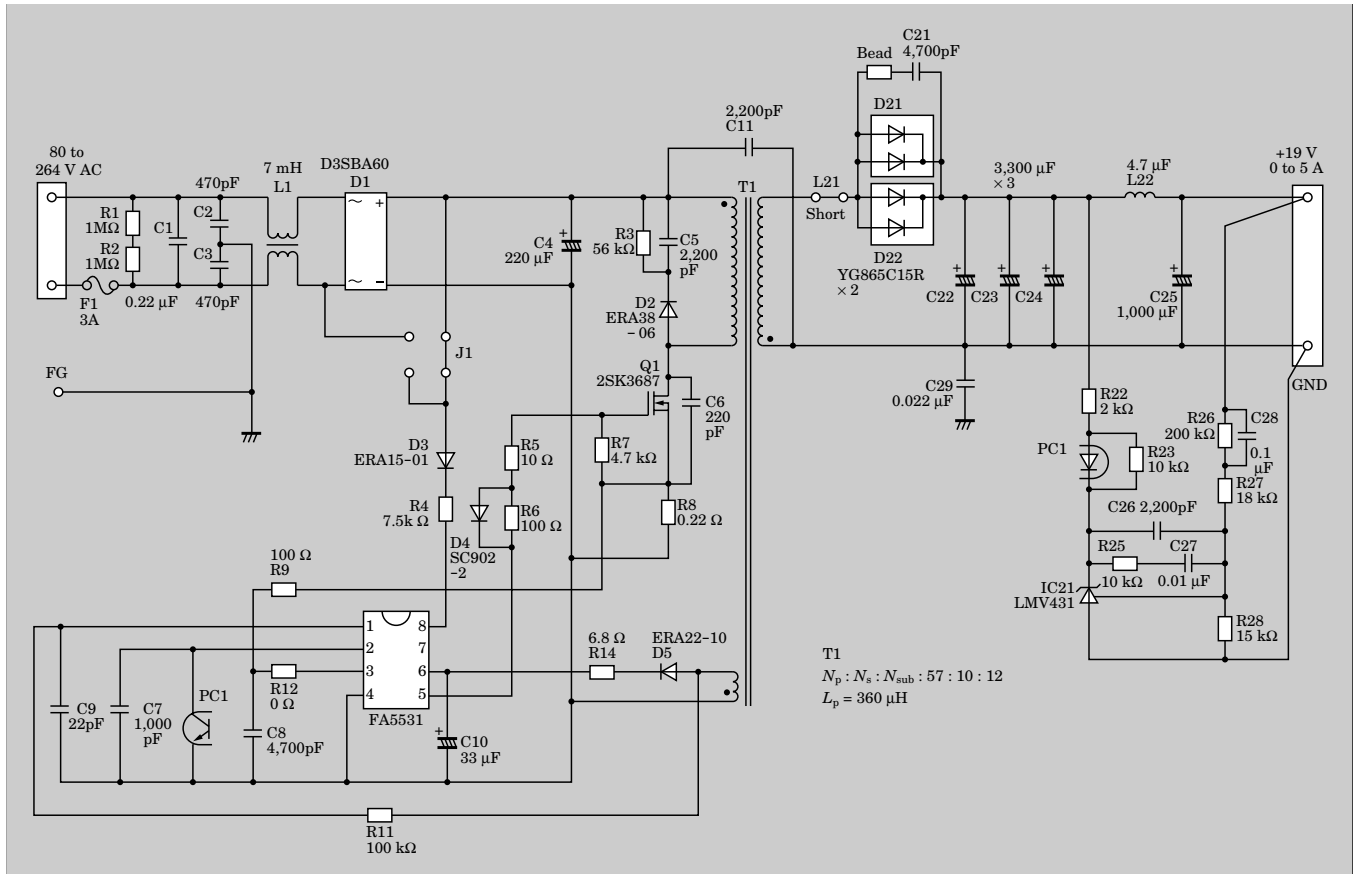

Fig.8 Switching waveform at maximum rated load (100 V AC input)

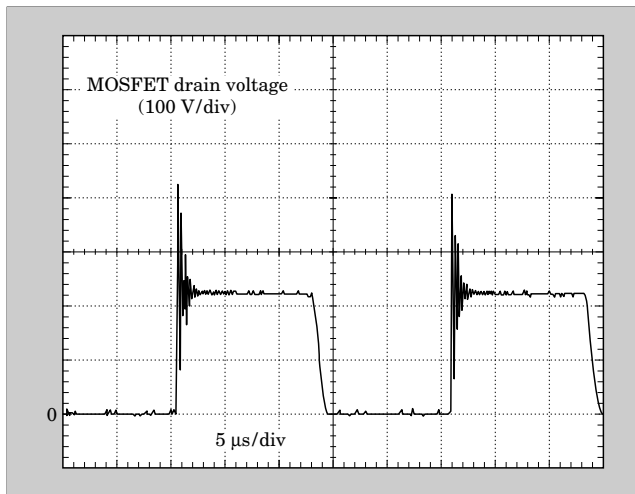
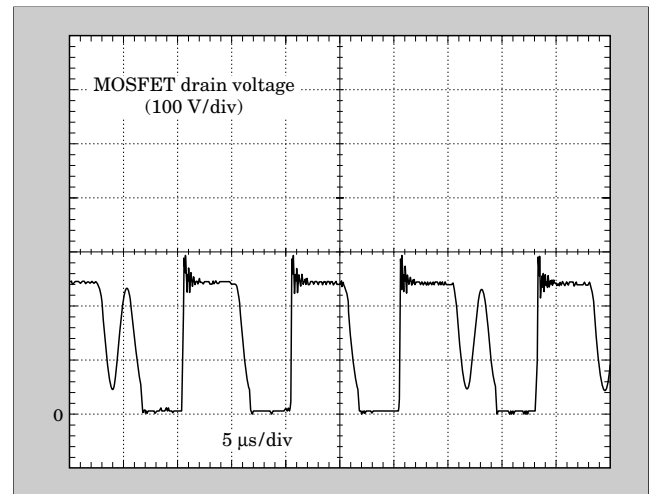

Fig.9 Switching waveform at 30 % load condition (100 V AC input)



at the second minimum.

Figure 10 shows the change in switching frequency as related to the output current, in the case where clamping was used. From the figure, it can be seen that the switching frequency increases as the output power decreases in the region extending from the rated load to a medium load. On the other hand, it can be seen that the switching frequency decreases as the load becomes lighter in the region extending from a

medium load to no load, and that the peak frequency occurs at 100 to 110 kHz.

3.3 Input power at unloaded condition

Power supply circuits used in typical electronic products can be observed operating at an unloaded condition when, for example, an AC adapter is plugged into an electrical outlet but the equipment that utilizes the power does not operate. In this case, since the

Fig.10 Switching frequency characteristics

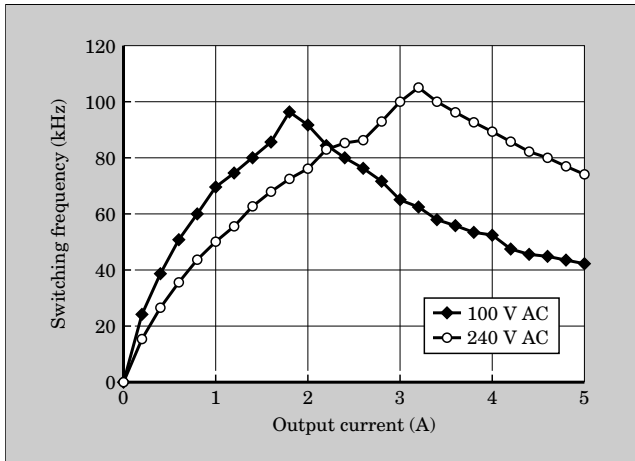
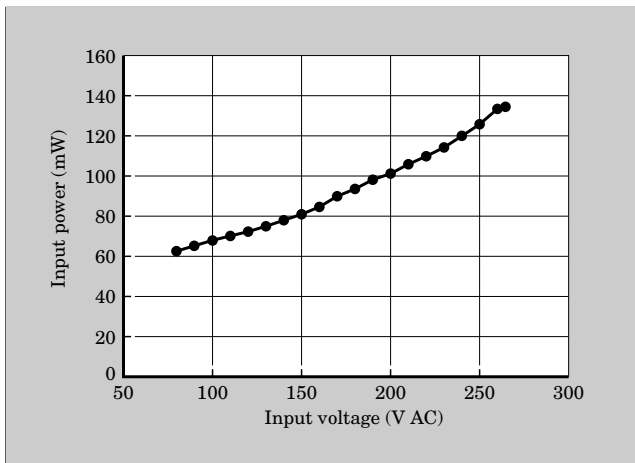

Fig.11 Input power characteristic at unloaded condition



equipment is not operating, all the power input during this unloaded condition is dissipated. From the perspective of energy savings, it is extremely important to reduce the input power during an unloaded condition.

Figure 11 shows the measured input power during unloaded operation with the power supply built for evaluation-use. The input power during unloaded operation of this evaluation-use power supply was suppressed to the low value of 67 mW in the case of 100 V AC, and 120 mW in the case of 240 V AC. Marketplace requirements concerning the input power during unloaded operation vary according to the set of components used, but input power of 300 mW or less is often desired, and the power supply built for evaluation-use achieves this value by a significant margin.

The suppression of input power during unloaded operation to a small value can be attributed to two main factors.

The first factor is the effect of the function for

Fig.12 Waveform at unloaded condition

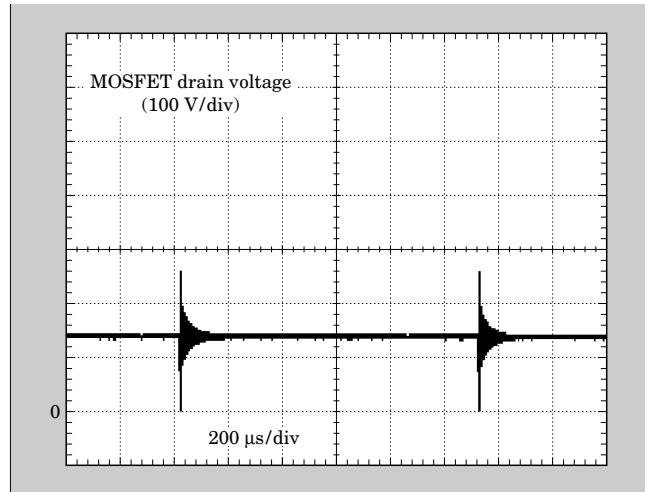

decreasing the switching frequency during operation at a light load. Figure 12 shows the switching waveform during the unloaded operation of this evaluation-use power supply. From this figure, it can be seen that the switching frequency drops to approximately 1 kHz. During unloaded operation or operation at a light load, switching loss can be reduced by decreasing the switching frequency.

Another factor is the effect of the startup circuit contained inside the IC. In the case of a conventional IC, the startup circuit was configured by attaching an external resistor, and this resistor generated a constant power loss of 100 mW, for example, even after the power supply operation had started. However, because Fuji Electric's newly developed IC contains an internal startup circuit, the power dissipation loss of the startup circuit can be reduced to nearly zero after the power supply has begun operation. This effect enables a reduction in the input power during unloaded operation.

4. Conclusion

An overview of the FA5530 and FA5531 quasi-resonant controller ICs with internal high-voltage startup current source has been presented. Another model, the FA5532 overload latch lockout IC is currently underdevelopment for addition to this series of ICs.

The functions essential for realizing lower standby power consumption in controller ICs equipped with an internal startup current source, without increasing the part count, have been envisioned and Fuji Electric remains committed to advancing and enhancing its series of ICs to meet the needs of various future requirements.